



BEST Mechanical & Electronic Locks; Keys/Cores & Door Closers

Price List

PL76 | January 2024 R2



BEST: Setting the Standard for Security

What's New

This price book dated January 2024 R2 contains updated product information.
All changes are listed below and take effect immediately.

BEST Mechanical & Electronic Locks; Keys/Cores, Access & Door Closers

- New options for Keystone web masterkey files
- 9KG / 9KBV Free Motion changed to Lost Motion
- Removed ED50LE (moving to dormakaba pricebook)
- EHD9000 Pricing added
- Part updates for 6K
- Part NP12A12V Backup battery for power supply now discontinued
- Removed Lockout name tag & Lockout/tagout (BD657/BD658) for B and D series
- Less cylinder option cost updated for 45H

This page blank intentionally

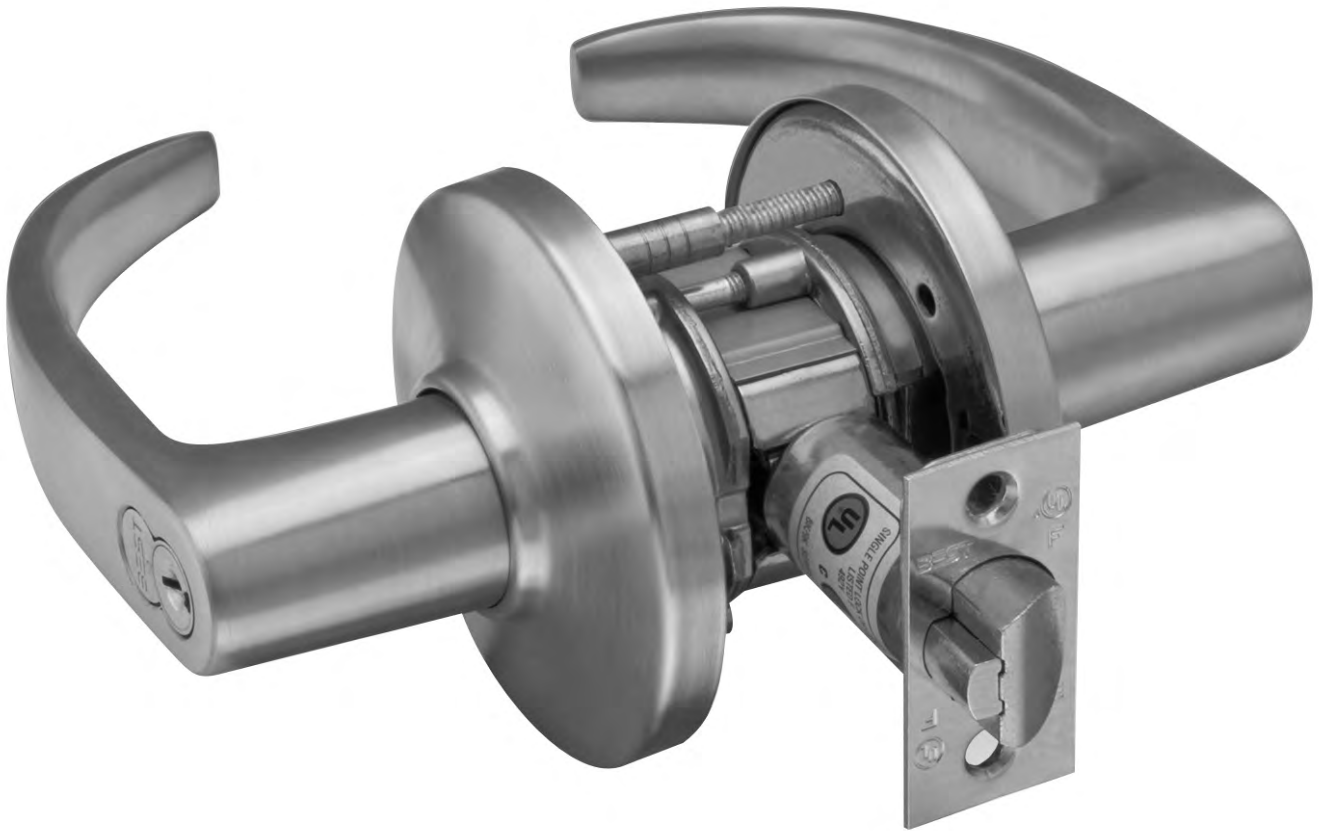

NOTE: Please contact us for price information on specialty items or options not shown in this price list.
dormakaba USA Inc. reserves the right to make changes in designs and specifications or to make additions or improvements to its products without notice and without incurring any obligation to incorporate them on products previously manufactured.

Contents

Terms & Conditions of Sale	5
BEST Patented Product Ordering & License	9
BEST Masterkey	10
Architectural Finishes	12
BEST Standard & Premium Keys	13
BEST Peaks® Keys	14
BEST Preferred Patented Keys	15
BEST CORMAX™ Patented Keys	16
B Series Padlocks	17
BEST Standard & Premium Cores	19
BEST Peaks® Cores	20
BEST Preferred Patented Cores	21
BEST CORMAX™ Patented Cores	22
D Series Service Equipment	23
KRD Series Key Retaining Devices	25
QU-IC-System Combining Tool Packages	26
E Series Cylinders	27
5E and 8E Series Utility Cylinders (Cam Locks)	29
Keystone® Web	30
45H Series Mortise Locks	31
47H Series High Security Mortise Lock	33
48H and 49H Series Mortise Deadlocks	34
40H Series Mortise Components	35
40H Strike Packages	36
40H Lever Sets	36
40H Replacement Spindles	37
40H Screw Kits	37
40H Faceplate Kits	37
40H Visual Indicator Thumb-Turn Kit	38
40H Indicator Laminate Kit	38
J Series Semi-Trailer Kingpin Locks	39
6K Series Grade 2 Cylindrical Locks - Knobs	40
7KC Series Grade 2 Cylindrical Locks - Levers	41
8K Series Grade 1 Cylindrical Locks - Knobs	42
9K Series Grade 1 Cylindrical Locks - Levers	44
AK Series Knob Adaptations (formerly KA series)	46
L Series Cabinet Locks	47
P Series Push Locks	48
S Series Sliding Door Locks	49
SPSL – Secure Patient Safety Lever	50
SSRL - Secure Seclusion Room/Time Out Room Locks	52
SEDA – Secure Emergency Door Alarm	53
T Series Tubular Deadbolts	54
W Series Electric Switch Locks	55
45HW Series Electromechanical Mortise Locks	56
47HW Series High Security Electromechanical Mortise Locks	57
8KW/9KW Series Electromechanical Cylindrical Locks	58

Electromagnetic Lock Accessories	59
45HZ Keypad EZ Mortise Locks	60
9KZ Keypad EZ Cylindrical Locks	61
EXZ Keypad EZ Exit Trim	62
45HG Offline G Series Mortise Locks	63
9KG Offline G Series Cylindrical Locks	64
EXG Offline G Series Exit Trim	65
45HBV Offline V Series Mortise Locks	66
9KBV Offline V Series Cylindrical Locks	67
EXBV Offline V Series Exit Trim	69
45HM IDH MAX™ Mortise Locks	70
9KM IDH MAX™ Cylindrical Locks	72
Electronic Lock Software & Accessories	73
BEST 45HQ Wireless Mortise Locks with Wi-Q™ Technology	74
BEST 9KQ Wireless Cylindrical Locks with Wi-Q™ Technology	76
BEST EXQ Wireless Exit Trim with Wi-Q™ Technology	77
BEST Wi-Q™ Technology Wireless Access Management Software & Accessories	78
BEST Wireless Conversion Kits with Wi-Q™ Technology	79
Electronic Lock Inside Escutcheon Conversion Kits	80
HD8000	81
HD7000	85
SL6000	89
ED50LE/ED100LE Low Energy Operators	92
D-4990 Low Energy Operator	93
EHD9000	95
Quoting & Ordering Policies	98
Construction Core Orders	100
Returned Authorization (RA)	101
Return Policy and Fulfillment Issues	102
Forms	103

TERMS AND CONDITIONS OF SALE

Acceptance. The following Terms and Conditions of sale are applicable to all Quotations, Contract, Purchase Orders, Order Acknowledgement Forms, and sales of Seller's services and products, and are the only applicable terms and conditions thereto, except for terms establishing prices, quantities, delivery schedules, terms of payment, invoicing, shipping instructions, and the identification of the products associated with each transaction. If any conflict exists between the Terms and Conditions and a Quotation, Purchase Order, Order Acknowledgment form, or sale, these Terms and Conditions shall prevail BY REQUESTING A QUOTATION OF ORDERING ANY PRODUCTS OR SERVICES FROM SELLER, BUYER AGREES TO ALL THE FOLLOWING TERMS AND CONDITIONS. If a written contract signed by both parties is in existence covering the sale of the goods and services, the terms and conditions of the contract shall control to the extent they are inconsistent with these Terms and Conditions.

1. Order Procedure. Buyer may or may not request the preparation of a Quotation prior to ordering any products or services from Seller. Buyer then shall place a Purchase Order with Seller. By placing a Purchase Order, Buyer makes an offer to purchase products or services from Seller pursuant to these Terms and Conditions. Seller, in its discretion, may accept or reject the Purchase Order. If Seller accepts the Purchase Order, Seller shall issue an Order Acknowledgement Form confirming Buyer's order. No Purchase Order is binding on Seller unless accepted by Seller as provided in these Terms and Conditions.

2. Quotations. All Quotations by Seller are subject to change or withdrawal without prior notice to Buyer unless otherwise specifically stated in the Quotation. Quotation prices are valid on Purchase Orders placed within 90 days of the quote being issued, unless otherwise specifically stated in the quotation. If no order is placed within the stated time frame, prices may be adjusted to reflect the then-current published prices, surcharges, escalators, or other pricing adjustment due to, among other things, costs of materials, labor, transportation, taxes, duties, and other cost increases to Seller. All resulting Purchase Orders become effective only if and when approved and accepted in writing by Seller by the issuance of its Order Acknowledgement Form. Seller reserves the right to discontinue manufacture of any products or change products materials, design, or specifications without notice.

Quotation prices are valid on Purchase Orders placed within 90 days of the quote being issued, unless otherwise specifically stated in this quotation. If no order is placed within the stated time frame, prices may be adjusted to reflect the then-current published prices, surcharges, escalators, or other pricing adjustment due to, among other things, costs of materials, labor, transportation, taxes, duties, and other cost increases to Seller. All resulting Purchase Orders become effective only if and when approved and accepted in writing by Seller by the issuance of its Order Acknowledgement Form. All Quotations and resulting orders are subject to Seller's Terms and Conditions set forth in the price book

.3. Site Requirements.

- a. The Quotation is contingent upon all work being performed during normal business hours unless otherwise negotiated and a mutually agreeable schedule. The Quotation is calculated on one continuous installation engagement based on acceptable site conditions where other dependent scopes have completed preparation for proposed materials [i.e. electrical work, floor work, adjacent construction]. When Buyer has given authorization for work to begin, no other scopes may impede Seller's ability to complete installation in agreed upon area. Seller reserves the right to invoice for costs that are incurred due to unacceptable site conditions or delays by others resulting in additional installation visits.
- b. Signed acceptance by Buyer of shop drawings and/or submittals shall be interpreted as acceptance that proposed scope is the correct interpretation of construction documents. Any field

verification and/or work required by others as detailed in the submittal will be provided and coordinated by Buyer. Work shall not begin nor shall orders be placed for any projects until all shop drawings and submittals have been approved in writing by Buyer.

4. Warranty. Seller warrants only that all products sold pursuant to a Quotation or Purchase Order will conform to the description in the Price Book and will be free from defects in workmanship and materials. The duration of each product warranty is dependent on the particular product. Refer to EAD & DHW warranty statement. Extended warranties may be available for an additional cost. Seller is not responsible for defects or damages caused by wear and tear, consumable materials, vandalism, fires, storms, floods, acts of God, misuse, abuse or alteration by any company other than Seller. Seller further warrants that Buyer will receive good and valid title to the products. Any claim on account of nonconforming or defective products or for any other cause whatsoever shall conclusively be deemed waived by Buyer unless written notice thereof is given to Seller promptly after discovery but no later than sixty (60) days from date of shipment. Seller shall have the right either to replace or repair any nonconforming or defective products, to refund the purchase price upon return of the products, or to grant a reasonable allowance on account of such nonconformance or defect Seller's liability and Buyer's exclusive remedy for nonconforming or defective products shall be limited solely to replacement, repair, refund, or allowance as Seller may elect. Seller shall be given reasonable opportunity to investigate all claims and no materials shall be returned to Seller until after inspection and approval by Seller and receipt by Buyer of written shipping instructions from Seller. Buyer acknowledges and agrees that the remedies set forth in this paragraph are Buyer's exclusive remedies for the delivery of nonconforming or defective products.

Additional Warranties

- a) No credit will be provided for any work completed by others during warranty term.
- b) Warranty work will be performed during normal business hours with our standard response times. Any warranty work taking place beyond normal business hours or with expedited response time may be billable.
- c) Products repaired or replaced under the warranty are warranted only through the remainder of the original warranty period.

Disclaimer of Further Warranties. Except as set forth above, there is no warranty, representation, or condition of any kind, express or implied (including no warranty of merchantability or fitness of the products for any use contemplated by Buyer) concerning Seller's products or services and none shall be implied by law.

5. Limitation of Liability and Remedies. Seller shall not be liable, and Buyer waives all claims against Seller for any incidental, consequential, or special damages, including without limitation, lost revenues and profits even if Seller has been advised of the possibility of such damages. Buyer's exclusive remedy for any cause of action under these Terms and Conditions is a claim for damages and in no event will damages or any other recovery of any kind against Seller exceed the purchase price of the specific products or services as to which the claim is made. Seller will not be liable to Buyer for any loss, damage, or injury to persons or property resulting from the handling, storage, transportation, resale, or use of the products in manufacturing processes, or in combination with other substances, or otherwise.

6. Intellectual Property Indemnification. (a) Seller agrees to defend, indemnify and hold Buyer harmless against any claims, costs, damages, liability and expenses resulting from actual or alleged patent, trademark, or copyright infringement, misappropriation of confidential information, or violation of any other intellectual property right, domestic or foreign, in the selling or use of any part or product that is owned by Seller and that pertains to the subject matter of a Quotation, Purchase Order, or

TERMS AND CONDITIONS OF SALE

sale of products or services [provided that the product is not modified in anyway by Buyer or any other party, and that the product is used in the manner intended by Seller]. If a suit or claim results in any injunction or any other order that would prevent Seller from supplying any product falling under a Quotation, Purchase Order, or sale, or if the result of such a suit or claim would, in the reasonable opinion of Seller, otherwise cause Seller to be unable

to supply such products, Seller shall have the right, at its option, if it so chooses, to do one or more of the following: (i) secure an appropriate license to permit Seller to continue supplying the products to Buyer; (ii) modify the relevant product so that it becomes non-infringing, provided that any modification does not cause any material change to the operation or performance of the product; or (iii) replace the relevant product with a non-infringing but practically equivalent product. (b) Buyer agrees to defend, indemnify, and hold Seller harmless against any claims, costs, damages, liability and expenses resulting from actual or alleged patent, trademark, or copyright infringement, misappropriation of confidential information, or violation of any other intellectual property right, domestic or foreign, in the making, using or selling of any product or using any process that is owned by Buyer or is designed or specified by Buyer and that pertains to the subject matter of a Quotation, Purchase Order, or sale.

7. Ownership of Inventions. All drawings, know-how, designs, confidential information, and the like disclosed to Buyer by Seller and all rights therein will remain the property of Seller. Buyer shall have no claim to, ownership interest in, no license to, or no rights to any information provided or communicated by Seller.

8. Lead Times. If applicable, lead times are based on standard requirements by factory to provide materials proposed. Ship dates will be provided as estimate only once order is placed with the factory. Adequate packaging will be provided for any normal shipping circumstance such that materials will be protected and labeled as required. Special packaging may be provided for an additional expense. Shipping will be cost effective unless expedited fees are accepted by Buyer. If materials are to be provided to job site or Buyer location, dormakaba will make an informed decision as to the best instruction to provide the shipping company. If materials are not required to have direct delivery, materials will be brought to branch for pickup by Buyer. All freight terms shall be FOB. Any claims for damage in transit or lost freight, receiving, and inspection of materials is the responsibility of Buyer. It is a requirement of Buyer to inspect and review all materials prior to accepting shipment.

9. Title/Risk of Loss. All products shall be shipped FOB Seller's manufacturing facility to Buyer's designated delivery location. Unless otherwise agreed by the parties, Seller shall select the method of and carrier for the products. Seller reserves the right to ship items in a single or in multiple shipments. Title and risk of loss to products ordered passes to Buyer upon delivery of the products to the freight carrier. Unless mutually agreed upon in writing, shipping dates are approximate and are based upon prompt receipt of all necessary information.

10. Prices. Quoted price is valid for 90 days. Seller reserve the right to revise quotations after the 90 days. All accepted Purchase Orders are subject to Seller's price in effect at time of shipment. Buyer shall be responsible for any increase in freight rates or transportation charges occurring after Seller prepared the Order Acknowledgment Form on the Order Acknowledgment Form. Buyer shall pay to Seller in addition to the purchase price the amount of all fees, duties, licenses, and all sales, use, privilege, occupation, excise, or other taxes, federal, state, local, or foreign which Seller is required to pay or collect in connection with products or services sold to Buyer.

11. Payments. Unless otherwise agreed in writing between the parties, all Seller's invoices are payable within thirty (30) days of their date. Time is of the essence. Interest on past due amounts will be assessed at the rate

of 2% per month (24% per annum), or the maximum allowable by law.

Seller reserves the right to full payment upon completion of work unless credit is pre-established. For any work requiring materials purchase or scheduling, a 50% deposit is due at time of proposal acceptance. Twenty percent (20%) of the Quotation, Purchase Order value may be billed after job award. Joint check agreements may be requested at the discretion of Seller. If payment is outstanding for any one account, work may be stopped and outstanding orders cancelled until account is restored. Should Seller require the use of collection, attorney's fees, or fees for insufficient funds, Buyer agrees that these funds will be repaid to Seller. Seller retains the right to file a lien against all or part of the property being improved. Seller reserves the right to add a 2.5% charge if invoice becomes delinquent beyond terms.

12. Cancellation. In the event a Buyer's Purchase Order and the issuance of an Order Acceptance Form is cancelled, it will be subject to standard 35% restocking fees, cancellation fees, engineering fees, materials & freight costs incurred, and administrative fees. Standard cancellation is 20% of order as long as no materials have been ordered. Should Buyer release material orders, Buyer will be liable for that portion of the job and 20% of the remaining amount of work unperformed/unordered.

13. Storage. If applicable, Seller reserves the right to implement a storage fee if delivery is delayed after agreed upon date. Should project timeline require storage of materials, Seller reserves the right to bill for those materials at the time they have been received at a Seller location, Buyer location, or at job site. Certificate of insurance for stored materials can be provided to Buyer upon request. Signed acceptance by Buyer of shop drawings and/or submittals shall be interpreted as acceptance that proposed scope is the correct interpretation of construction documents. Any field verification and/or work required by others as detailed in the submittal will be provided and coordinated by Buyer.

14. Insolvency. Seller may, at any time or times, suspend performance of any order or require payment in cash, security, or other adequate assurance satisfactory to Seller when, in Seller's opinion, the financial condition of Buyer or other grounds for insecurity, including the filing of a petition for bankruptcy, warrant such action.

15. Force Majeure. Seller shall not be liable for any delay in fulfilling any order due to (a) fires, floods, strikes, or other labor disputes, accidents to machinery, acts of sabotage, riots, precedence or priorities granted at the request or for the benefit, directly or indirectly, of the federal or any state government or any subdivision or agency thereof, delays in transportation or lack of transportation facilities, restrictions imposed by federal or state legislation or rules of regulations thereunder; or (b) any cause beyond the control of Seller.

16. Ownership of Equipment. Unless otherwise agreed in a writing, all material, equipment, facilities, and special tooling, which term includes but is not limited to jigs, dies, fixtures, molds, patterns, special taps, special gauges, special test equipment, and manufacturing aids and replacements thereof, used in the manufacture of the products covered by any order shall remain the property of Seller. Any material, tooling, and equipment furnished to Seller by Buyer shall be and remain the personal property of Buyer with the title to and right of possession remaining in Buyer.

17. Confidential Information. All information furnished or made available by Seller to Buyer in connection with a transaction shall be held in confidence by Buyer. Buyer agrees not to use such information or disclose such information to others without Seller's prior written consent. The obligations of this paragraph does not apply to any information which (a) at the time of disclosure was, or thereafter becomes, generally available to the public by publication or otherwise through no breach by Buyer of any obligation herein, (b) Buyer can show by written records was in Buyer's possession prior to disclosure by the disclosing party,

TERMS AND CONDITIONS OF SALE

(c) is legally made available to Buyer by or through a third party having no direct or indirect confidentiality obligation to Seller with respect to such information, (d) was independently developed by Buyer without use of any of Seller's confidential information, or (e) is required to be disclosed pursuant to applicable law.

18. Waiver. No waiver by Seller of any of these Terms and Conditions shall be effective unless explicitly set forth in writing and signed by Seller. No failure to exercise, or delay in exercising, any rights, remedy, power, or privilege arising from these Terms and Conditions shall operate or be construed as a waiver thereof, nor shall any single or partial exercise of any right, remedy, power, or privilege hereunder preclude any other or further exercise thereof or the exercise of any other right, remedy, power or privilege.

19. Assignment. No assignment of any right or interest or delegation of any obligation or performance of Buyer under this order may be made without the prior written consent of Seller. Any attempted assignment or delegation will be wholly void and totally ineffective for all purposes.

20. Choice of Law. All sales, agreements for sale, offers to sell, proposals, acknowledgments and contracts of sale, including, but not limited to, Purchase Orders accepted by Seller, shall be considered a contract under the laws of the State of Delaware, and the rights and duties of all persons, and the construction and effect of all provisions hereof, shall be governed by and construed according to the laws of the State of Delaware.

21. Integration Clause. These Terms and Conditions constitute the entirety of terms and conditions, except as set forth in paragraph one, governing the sale and purchase of products and services sold by Seller. No modification of these Terms and Conditions shall be of any force or effect unless in writing and signed Seller and Buyer. Buyer may desire to utilize its own form of acknowledgment or acceptance of these Terms and Conditions. However, the use of any such form shall be for convenience only. No modification of these Terms and Conditions shall be affected by the acknowledgment or acceptance of purchase orders, shipping instruction forms, bills of lading or any other document containing terms or conditions at variance with or in addition to those set forth herein, all such varying or additional terms being hereby objected to and rejected by Seller and deemed to be waived by Buyer.

22. Installation Projects. Communication: Buyer shall communicate all of these installation terms to any end-user receiving installation services from dormakaba. **Work Execution:** Any installation quote is prepared with the understanding that openings within the scope of work ("Work") have doors and frames in good working order. dormakaba will perform the Work in the order set forth in a field survey conducted by an end-user, an end-user consultant, or Buyer prior to beginning the installation. Work shall occur weekdays during normal business hours (M-F, 8am – 5pm, local time). Work performed outside of normal business hours is available at a rate of 135% of the normal base rate. Any Work requested to be performed outside of normal business hours will require start and stop time confirmation with installation site, such start and stop time to be obtained by the Buyer or the end-user. Installation Projects are performed as one continuous installation event, from commencement until the completion of the installation. Unless specifically noted otherwise in writing, there will be additional charges for delays or additional trips not caused by dormakaba. Commencement of installation is conditioned on acceptable site conditions, including the completion of dependent scopes of work (e.g., electrical work, keying meetings, distribution of credentials). When Buyer or end-user has given authorization for work to begin, Buyer or end-user shall ensure no other scopes may impede dormakaba's ability to complete installation in agreed upon area. dormakaba reserves the right to assess a fee for costs incurred due to unacceptable site conditions or delays by others resulting in additional installation visits. Union labor, prevailing wage, and certified payroll are excluded from the installation quote unless otherwise set forth in writing. Insurance certificates will be provided upon request. Coverage is limited to the types and amounts set forth on the insurance certificate. Includes execution of materials only as detailed within proposal. Additional Charges: Additional charges may be assessed for delays or additional

install time to correct any deficiencies or discrepancies between scope of work and actual jobsite. Any dormakaba materials delivered to Buyer but missing from installation site will be reordered at customer's expense. Any hardware changes or change orders shall be quoted on a separate proposal and timeline. Storage: dormakaba reserves the right to assess a storage fee if Buyer or end-user causes delivery to be delayed after the agreed upon delivery date. Should project timeline require storage of materials after delivery to Buyer or end-user, through no act or omission of dormakaba, dormakaba reserves the right to assess a storage fee, Buyer location, or at job site. Certificate of insurance for stored materials can be provided to Buyer upon request. Exclusions: Unless explicitly included in the installation quote, these are excluded: Distribution to staff of any form of keys, fobs or cards or credentials; any temporary security, barricades, or signage; all carpentry work outside of this specification including drywall, paint, framing, patching of existing holes, etc.; union labor, prevailing wage & certified payroll unless noted otherwise; permits are the responsibility of the end-user; Any special consideration for asbestos and lead paint hazards; any bonds; disposal of material and packaging; damage from negligence, vandalism or Force Majeure; cleaning of site beyond broom clean; cost for special insurance requirements; consumable materials (e.g., batteries); any electrical work including 120v connections and low voltage wiring pulls; and other similar categories of labor and materials not included in the installation quote.

23. Installation Warranty dormakaba will provide one (1) year warranty on materials to be free from manufacturer defects and on installation labor performed. Extended warranties are available for an additional cost. dormakaba is not responsible for defects or damages caused by wear and tear, consumable materials (e.g., batteries), vandalism, fires, storms, floods, acts of God, misuse, abuse, or alteration on by any company other than dormakaba. No credit will be provided for any work completed by others during warranty term. dormakaba reserves the right to withhold the performance of warranty work if Buyer payments have become past due. Warranty work will be performed during normal business hours with our standard response times. Any warranty work taking place beyond normal business hours or with expedited response time may be billable. In the event that Buyer, its agents, employees, successors, and/or assigns tampers with, misuses, removes any parts, or adds any parts or equipment, Buyer agrees to indemnify, save and hold harmless dormakaba, its agents, employees, successors, and/or assigns, from any and all liability, damages, or losses, including reasonable attorney's fees, arising out of, or incidental to, the aforementioned conduct. dormakaba warrants that all goods manufactured by dormakaba and all services provided by dormakaba hereunder will be free from defects in workmanship and materials for twelve (12) months from the date of final project invoice to the carrier, unless sold as "With All Faults", "Shop", "As Is", "As They Stand" or other similar designation. Products repaired or replaced under the warranty are warranted only through the remainder of the original warranty period.

April 2023

BEST PATENTED PRODUCT ORDERING & LICENSE

SALE OF BEST PATENTED PRODUCT: In accordance with the [dormakaba USA Inc. \("dormakaba USA"\) Masterkey Code and Masterkey Service Policy](#), only Authorized Distributors meeting certain necessary qualifications and standards shall be selected by dormakaba USA to sell Best Patented Product. Selection shall be at the sole discretion of dormakaba USA and shall be evidenced in writing via the Distributor Agreement or its select addendums.

STOCKING OF BEST PATENTED PRODUCT: Furthermore, dormakaba USA may authorize only select Authorized Distributors to purchase and stock Best Patented Product and have access to [Best Patented Masterkey Codes by entering into a Best Patented Masterkey System Distributor Agreement Addendum](#) (the "Authorized Stocking Distributor"). As a condition to the Authorized Stocking Distributor's continued access to Best Patented Masterkey Codes, it must comply at all times with the Best Patented Key Systems Security Procedure.

SECURITY AUTHORIZATION FORM: It is a responsibility of the Authorized Distributor to ensure that Best Patented Product does not end up in the possession of unauthorized individuals or entities. The Authorized Distributor must ensure that the End User completes a Best Patented Masterkey System Security Authorization Form (the "[Security Authorization Form](#)"). The [Security Authorization Form](#) designates those individuals within the End User's organization that are authorized to place orders with the Authorized Distributor for Best Patented Product. The [Security Authorization Form](#) must be completed and signed by the End User.

It is the Authorized Distributor's full responsibility to validate the End User's signature as identified on the [Security Authorization Form](#) prior to accepting any orders for Best Patented Product.

In certain circumstances the Authorized Distributor selling and/or stocking the Best Patented Product will not contract directly with the End User. In these circumstances, the Authorized Distributor is required to work with its reseller to ultimately ensure that the End User submits a signed [Security Authorization Form](#) to dormakaba USA.

For those Distributors who have been authorized by dormakaba USA to stock Best Patented Product, it is their responsibility to ensure that they have a completed Security Authorization Form on file for each End User that places an order with the Authorized Stocking Distributor for Best Patented product and that the Authorized Stocking Distributor authenticates the signature of each Best Patented Product order utilizing the Security Authorization Form.

dormakaba USA shall have the right to audit all [Security Authorization Forms](#) maintained by the Authorized Distributors for completeness, accuracy and compliance with this Policy.

BEST CORMAX™ PATENTED KEYING SYSTEM-PATENT LICENSE:

1. The Best Cormax keying system being offered for sale under this price catalog is protected by valid and enforceable patents issued by the United States Patent and Trademark Office pursuant to United States Federal Law (including U.S. Patent Nos. 7,681,425 and 5,615,566 (also designated as US RE 39,364) (collectively, the " Best Patents"). The rights to the Best Patents belong to dormakaba USA Inc. ("dormakaba USA"). The Best Cormax keying system is comprised of two main components, a core and one or more keys. The combination of the Best Cormax core and key(s) is protected by the Best Patents. The Best Cormax keys, key blanks, and cores contain registered trademarks belonging to dormakaba USA. **dormakaba USA considers its patent and trademark rights to be valuable intellectual property assets that are important in protecting security and maintaining key control of its products. Accordingly, it is in dormakaba USA's best interest and, more importantly, it is in the best interest of its end users, that the Best Cormax system be managed in a manner that guards against unauthorized key duplication, which compromises the security of the Best Cormax system.** As a condition of purchase of a Best Cormax system from dormakaba USA or one of its authorized distributors, the following limitations on the express and implied contractual and intellectual property rights with respect to the Best Cormax system and the Best Patents shall apply:

- a. All Best Cormax systems shall be sold with a limited license to practice the Best Patents by combining and using (i) the Best Cormax core that is purchased with the Best Cormax system with (ii) the Best Cormax key(s) and/or key blanks(s) that are purchased with the Best Cormax system.
- b. This license is conditioned upon the purchase of a Best Cormax core and key (or core and key blank) combination only from dormakaba USA or one of its authorized distributors. Only dormakaba USA and its authorized distributors are authorized to sell the core and key(s)/blank(s) that comprise the Best Cormax system. All other sales of those items, individually or together, including either finished Best Cormax keys or unfinished key blanks suitable for finishing into Best Cormax keys, by any party other than dormakaba USA or one of its authorized distributors, for purposes of making the patented core and key combination, are not authorized sales and are excluded from this license.
- c. In the event that an end user sells a Best Cormax core, either standing alone or in connection with a sale of the structure or building in which it is installed, to a third party, the end user shall be required to notify the third-party purchaser of the terms and conditions and limitations of this license, which equally apply to the third party purchaser.

BEST PATENTED PRODUCT ORDERING & LICENSE (continued)

- d. dormakaba USA does not grant under the license, the right to sell any Best Cormax keys or key blanks to a third party, except in connection with a sale of the corresponding Best Cormax core in a manner that complies with the terms, conditions, and limitations of this license.
- e. Best Cormax keys and/or key blanks will be shipped by dormakaba USA or one of its authorized distributors directly and only to employees, as designated in the Security Authorization Form.
- f. In order to maintain the integrity of the Best Cormax system, the Best Cormax key or key blank should not be altered at any time to operate any core/cylinder for which such key or key blank was not originally intended.
- g. In the event that any of the procedures outlined herein are not strictly followed with respect to the handling of Best Cormax keys and key blanks, dormakaba USA may require following good faith discussions, the prompt return via UPS/AOD or equivalent, of all Best Cormax keys and/or blanks. Those items, in like new condition, shall be repurchased by dormakaba USA at the original sale price less a restocking fee.
- h. Should any terms of this license be found to be invalid, by operation of law or otherwise, all other provisions herein shall remain in full force and effect.

BEST MASTERKEY CODE AND MASTERKEY SERVICE POLICY

I. DISTRIBUTOR MASTERKEY SERVICES

All dormakaba USA Inc. ("dormakaba USA") Authorized Distributors, Aftermarket Wholesalers, and Locksmiths ("Authorized Distributors") can create, modify or extend masterkey codes for the benefit of their end user customers ("End Users") for Best non-patented masterkey systems; provided, however, the services must be performed in line with industry standards. With the express written permission of dormakaba USA, select Authorized Distributors can create, modify or extend masterkey codes for the benefit of End Users for a Best Patented Masterkey System (pursuant to the terms and conditions of Section C below). Authorized Distributor's failure to comply with the terms of this policy could result in dormakaba USA's termination of its Distributor Agreement as well as dormakaba USA's pursuit of any remedies available at law.

A. END USER INFORMATION AND CODE RELEASE:

All masterkey codes (both patented and non-patented) previously generated by dormakaba USA are available for distribution to End Users (and/or their designated Authorized Distributor, if applicable) via the End User Web Portal at <http://masterkeycodeportal.bestaccess.com/Login.aspx>. For a hard copy of the End User Information and Code Release Form, please contact your dormakaba USA End User Consultant. End user codes will be distributed solely to those Authorized Distributors (a) identified by the End User on a fully executed End User Information and Code Release Form received by Best, and (b) for the release of Best Patented Masterkey Codes, the Authorized Distributor is authorized by dormakaba USA to receive and process Best Patented Masterkey Codes (as more fully described in Section C below.) No exceptions will be made to this policy.

B. BEST NON-PATENTED MASTERKEY SYSTEM

As of September 4, 2012, dormakaba USA no longer requires a Security Authorization Form to be signed by the End User prior to dormakaba USA and/or its Authorized Distributor accepting core and key orders for non-patented keying systems. All valid End User communications for orders related to non-patented keying systems will be fulfilled at the End User's liability.

C. BEST PATENTED MASTERKEY SYSTEM

The Best Patented Masterkey System provides a higher level of protection against unauthorized key duplication and crossovers and, in order to maintain the quality of a Best Patented Masterkey System, the following terms and conditions of this policy shall apply to any and all Authorized Distributors with access to Best Patented Masterkey Systems. For the purpose of this policy, "Best Patented Product" shall mean the Best Cormax (including cores and keys), as well as any and all future product dormakaba USA designates as patented product for the purpose of this policy. "Best Patented Masterkey Systems" and "Best Patented Masterkey Codes" shall mean the respective masterkey system or codes of any Best Patented Masterkey Product.

Sale of Best Patented Product: As further described in this Section C, only those Authorized Distributors meeting certain necessary qualifications and standards shall be selected by dormakaba USA to sell Best Patented Product. Selection shall be at the sole discretion of dormakaba USA and shall be evidenced in writing via the Distributor Agreement or its select addendums.

Best Patented Security Authorization Form: It is a responsibility of the Authorized Distributor to ensure that Best Patented Product does not end up in the possession of unauthorized individuals or entities. The Authorized Distributor must ensure that the End User completes a Best Patented Masterkey System Security Authorization Form (the "Security Authorization Form") as outlined in this Section C. The Security Authorization Form designates those individuals within the End User's organization that are authorized to place orders with the Authorized Distributor for Best Patented Product. The Security Authorization Form must be completed and signed by the End User.

It is the Authorized Distributor's full responsibility to validate the End User's signature as identified on the [Security Authorization Form](#) prior to accepting any orders for Best Patented Product.

In certain circumstances the Authorized Distributor selling the Best Patented Product will not contract directly with the End User. In these circumstances, the Authorized Distributor is required to work with its reseller to ultimately ensure that the End User submits a signed [Security Authorization Form](#) to dormakaba USA.

dormakaba USA shall have the right to audit all [Security Authorization Forms](#) maintained by the Authorized Distributors for completeness, accuracy and compliance with this Policy.

Sale of Combined Best Patented Product through Distributor:

dormakaba USA may authorize select Authorized Distributor to purchase and resell to an End User Best Patented Product that has been combined by dormakaba USA Personnel. In this instance, a [Security Authorization Form](#) must be completed and signed by the End User and provided by the Authorized Distributor to dormakaba USA with each Best Patented Product order.

Stocking of Best Patented Product:

dormakaba USA may authorize select Authorized Distributors to purchase and stock Best Patented Product and have access to Best Patented Masterkey Codes by entering into a [Best Patented Masterkey System Distributor Agreement Addendum](#) (the "Authorized Stocking Distributor") As a condition to the Authorized Stocking Distributor's continued access to Best Patented Masterkey Codes, it must comply at all times with the [Best Patented Key Systems Security Procedure](#). In addition, it is the responsibility of the Authorized Stocking Distributor to ensure that they have a completed [Security Authorization Form](#) on file for each End User that places an order with the Authorized Stocking Distributor for Best Patented product and that the Authorized Stocking Distributor authenticates the signature of each Best Patented Product order utilizing the [Security Authorization Form](#).

Best Patented Masterkey Code Generation:

To assist in reducing the possibility of duplication within a keying system and ensure security, all Best Patented Masterkey Codes must be created, modified and/or extended by Best's masterkey personnel and/or an Authorized Stocking Distributor. The unauthorized duplication or release of Best Patented Masterkey Codes to non-authorized people or organizations, including, but not limited to, unauthorized distributors, wholesalers, private locksmiths, other lock manufacturers, architects, or contractors, is a violation of this policy as well as the infringement of patent rights and other intellectual property rights of dormakaba USA. In addition to any other recourse available under law, the unauthorized release of Best Patented Masterkey Codes by any Authorized Stocking Distributor shall result in immediate termination.

Best Patented Masterkey System Exclusive Keyways:

Upon request from an End User to release Best Patented Masterkey Codes previously generated by dormakaba USA that are on an exclusive keyway, dormakaba USA will send a notification to the End User reminding them that their patented codes are on an exclusive keyway. dormakaba USA will provide a copy of this notice to the Authorized Stocking Distributor. To assist in reducing the possibility of duplication within an End User exclusive keying system and ensure security, all exclusive Best Patented Masterkey Codes must be created, modified and/or extended and recorded in dormakaba USA's BESTCode masterkey code management tool.

Should dormakaba USA approve an Authorized Stocking Distributor to

establish a Best Patented Masterkey System on an exclusive keyway, the Authorized Stocking Distributor shall be required to sign a [Best Patented Masterkey System Exclusive Keyway Addendum](#). To assist in reducing the possibility of duplication within a Distributor exclusive keying system and ensure security, all exclusive Best Patented Masterkey Codes must be created, modified and/or extended and recorded in dormakaba USA's BESTCode masterkey code management tool.

BEST MASTERKEY CODE AND MASTERKEY SERVICE POLICY (continued)

Copies of Best Patented Masterkey Codes: dormakaba USA shall have a right to a copy of all Best Patented Masterkey Codes that have been originated, modified, extended or otherwise maintained by the Authorized Stocking Distributor in the dormakaba USA BESTCode system in order for dormakaba USA to be able to provide continued support either directly, or indirectly, to the End User.

II. BEST MASTERKEY SERVICES

A. BEST MASTERKEY SERVICES PROVIDED TO DISTRIBUTOR:

dormakaba USA, upon request and at its sole discretion, may provide select masterkey services to an Authorized Distributor for both non-patented masterkey systems and Best Patented Masterkey Systems. In order for an Authorized Distributor to place an order for the extension of, or modification to, a masterkey system previously created or maintained by dormakaba USA, the End User must have selected that Authorized Distributor as its authorized designee in the End User Information & Code Release Form received by dormakaba USA. Complete keying instructions must be given before a Best order can be properly acknowledged with an estimated delivery date. dormakaba USA reserves the right to charge for the service of a customized masterkey security solution with the purchase of a Best product. A master key service charge of \$120 (net) will be assessed for each new construction core that is being used in a non dormakaba manufactured Small Format Interchangeable Core product. Best Patented Masterkey System products shall not be provided without the associated masterkey services being provided by dormakaba USA. All Masterkey Services provided by dormakaba USA shall be subject to the terms and conditions of the Best Masterkey Service Order Acknowledgment which shall be provided upon acceptance of the order for Masterkey Services.

B. BEST BESTCODE:

dormakaba USA may, in its sole discretion, make available its BESTCode masterkey code management tool to select Authorized Distributors that meet certain training and certification requirements. If offered, BESTCode will be made available for an annual subscription fee as outlined in the Best pricing catalog. All codes made available to Authorized Distributors in the BESTCode system shall be subject to the BESTCode User License Agreement and will be provided in accordance with this Policy. The BESTCode masterkey code management tool is not available for use with dormakaba Commercial Hardware products.

III. FORMS

For a copy of the following forms please contact the dormakaba USA End User Consultant.

- End User Information and Code Release Agreement
- Best Patented Masterkey System Distributor Agreement Addendum (Exhibit B)
- Best Patented Masterkey System Security Authorization Form
- Best Patented Key Systems Security Procedure
- Best Patented Masterkey System Exclusive Keyway Addendum
- Best Patented Masterkey System End User Specific Distributor Agreement Addendum (Exhibit D)

dormakaba USA reserves the right to change, modify or update this Policy at any time, in its sole discretion.

Architectural Finishes

BHMA No.	U.S. No.	Description
605	3	Bright brass, clear coated
606	4	Satin brass, clear coated
611	9	Bright bronze, clear coated
612	10	Satin bronze, clear coated
613	10B	Oxidized satin bronze, oil rubbed
618	14	Bright nickel plated, clear coated
619	15	Satin nickel plated, clear coated
622	19	Flat black, coated
625	26	Bright chromium plated
626	26D	Satin chromium plated
627	27	Satin aluminum, clear coated
628	28	Satin aluminum, clear anodized
629	32	Bright stainless steel
630	32D	Satin stainless steel
690	20	Dark bronze coated
600		Primed (painted)
689		Aluminum (painted)
690		Statuary bronze (painted)
691		Dull bronze (painted)
693		Black (painted)
695		Dark duranodic bronze (painted)
696		Gold (painted)

*finishes may not all apply to all products

BEST Standard & Premium Keys

How To Order

IA	1	A	1		
Key Shape (Bow)	Key Type	Keyway	Cut Code	Key Stamp	Options
1A – Standard 1AP – Premium 2A – Large round 3A – Large rectangular 4A – Access bow 9A – Blockout blade	0 – Blockout blade 1 – Operating or blank 2 – Control 3 – Master 4 – Submaster 5 – Grandmaster 9 – Extractor key	Designate specific keyway (A, E, etc.) or multiple keyways if ordering a multi-milled key.	1 – Blank 2 – Cut	KS654 x KS292 – BEST logo full embossing with stars (1A & 1AP only) KS112 – "U.S. Gov't do not duplicate" KS567 – Premium Specify KS#. Price for most custom design stamps available upon request*	B* – Long blade (1A only) H* – No hole (2A only) N* – Long nose (1A only) NKW – No keyway designation (standard on 1AP) S* – Key serialization

*Indicates extra cost option, see below.
 If keys are cut, you must specify keymark and number of each marking.

Description	Premium	Standard
1A Series		
Blanks	8.20	5.00
Operating-cut	21.00	14.60
Control, Master, SM or GM-cut	29.00	16.00
2A, 3A & 4A Series		
Blanks	N/A	8.10
Operating-cut	N/A	16.10
Control, Master SM or GM-cut	N/A	26.00
9A Series		
Blockout blades	26.00	17.10
Extractor key (9A9)	26.00	17.10

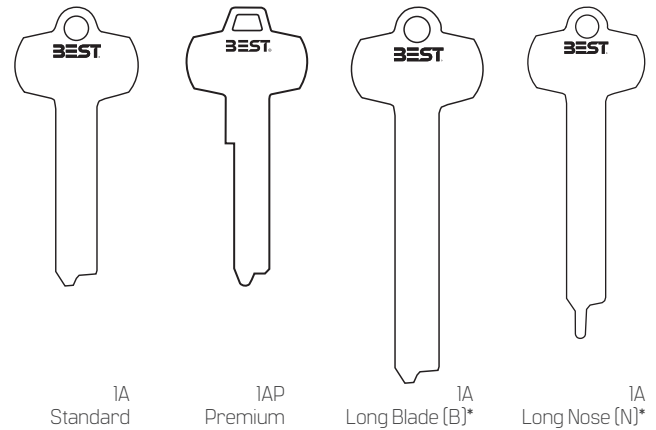

Extra Cost Options*	Option Code	Add-On
Double milling		5.60
Triple milling	Specific Keyways	8.60
Quadruple milling		14.00
Five milled		25.00
Long blade (1A only)	B	5.60
No hole (2A only)	H	3.70
Long nose (1A only)	N	11.00
Key serialization / key	S	3.70

NOTE 1: Graphics and company logos are available upon request.
 NOTE 2: Minimum 200 Keys Per Order.

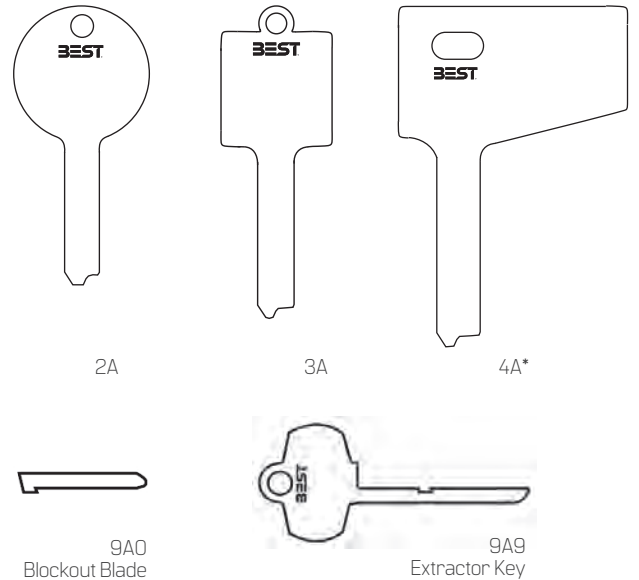

How To Order

IAK	1	B1	1	7	150	
Key Shape (Bow)	Key Type	Keyway	Cut Code	Pin Size	Key Series	Options
IAK - BEST Peaks	0 – Blockout blade	B1	1 - Blank	6 - 6-pin (140 & 150 series)	150	CS* - Custom stamp for key bow (Note 1)
9AK - Blockout blade	1 – Operating	B2	2 - Cut	7 - 7-pin (150 series only)	140	
	2 – Control	B3		140 Series = ICK cores		
	3 – Master	B4		150 Series = ICB cores		
	4 – Submaster	B5				
	5 – Grandmaster	B6				
	9 – Extractor key	B7				
		B8				
		B9				
		B10				

*Indicates extra cost option, see below.
If keys are cut, you must specify keymark and number of each marking.

Description	Patented
IAK Series	
Blanks	1340
Operating-cut	3500
Control, Master, SM or GM-cut	3800
9AK Series	
Blockout blade	3700

Extra Cost Options*	Add-On
List price add-on per key blank (Note 2)	2.70

NOTE 1: Graphics and company logos are available upon request.
NOTE 2: Minimum 200 key blanks per order.

BEST Preferred Patented Keys

How To Order

IAF	1	1P	1	7
-----	---	----	---	---

Key Shape (Bow)	Key Type	Keyway	Cut Code	Pin Size	Options
IAF – Preferred Patented	0 – Blockout blade	1P	1 – Blank	7 – 7-pin (150 series ICF cores only)	CS* – Custom stamp for key bow (Note 1)
9AF – Preferred Blockout Blade	1 – Operating	2P	2 – Cut		
	2 – Control	7P			
	3 – Master	8P			
	4 – Submaster	9P			
	5 – Grandmaster	10P			
	9 – Extractor key				

*Indicates extra cost option; see below.
If keys are cut, you must specify keymark and number of each marking.

Description	Patented
IAF Series	
PATENTED blanks	13.90
Operating-cut	35.00
Control, Master, SM or GM-cut	40.00
9AF Series	
Blockout blade & extractor key set	116.00

Extra Cost Options*	Add-On
List price add-on per key blank (Note 2)	2.70

NOTE 1: Graphics and company logos are available upon request.
NOTE 2: Minimum 200 key blanks per order.

How To Order – M Series

IAM	1	MM	2	1	KS716	
-----	---	----	---	---	-------	--

Key Shape (Bow)	Key Type	Keyway	Level	Cut Code	Key Stamp	Options
1AM – M series key	0 – Blockout blade	MJ MK	1 – Non-exclusive	1 – Blank	KS716 – IAM Front	B* – Long blade (IAM series only)
2AM – Large round	1 – Operating or blank	ML MM	2 – Two-digit zip code exclusive	2 – Cut	KS800 – IAM Back	H* – No hole (2AM series only)
3AM – Large rectangular	2 – Control		3 – One digit zip code exclusive			N* – Long nose (IAM series only)
4AM – Access bow	3 – Master		4 – National exclusive			S* – Key serialization
9AM – Blockout blade	4 – Submaster					
	5 – Grandmaster					
	9 – Extractor key					

*Indicates extra cost option; see below.
 Designate multiple keyways if ordering a multi-milled key.
 If keys are cut, you must specify keymark and number of each marking.
 **Must specify keyway when ordering blockout blades

How To Order – X Series

IAX	1	XI	X	1	KS699	
-----	---	----	---	---	-------	--

Key Shape (Bow)	Key Type	Keyway	Level	Cut Code	Key Stamp	Options
1AX – X series key	0 – Blockout blade	XI.X32, etc.	W – Non-exclusive	1 – Blank	KS717 – IAX Front	S* – Key serialization
9AX – Blockout blade	1 – Operating or blank		X – Two-digit zip code exclusive	2 – Cut	KS699 – IAX Back	
	2 – Control		Y – One digit zip code exclusive			
	3 – Master		Z – National exclusive			
	4 – Submaster					
	5 – Grandmaster					
	9 – Extractor key					

**Indicates extra cost option; see below.
 Designate multiple keyways if ordering a multi-milled key.
 If keys are cut, you must specify keymark and number of each marking.
 **Must specify keyway when ordering blockout blades"

Description	Patented
1AM Series	
Blanks	8.90
Operating-cut	18.90
Control, Master, SM or GM-cut	21.00
1AX Series	
Blanks	8.90
Operating-cut	18.90
Control, Master, SM or GM-cut	21.00
2AM, 3AM & 4AM Series	
Blanks	9.20
Operating-cut	16.80
Control, Master, SM or GM-cut	27.00
9AM & 9AX Series	
Blockout Blades	21.00
Extractor key (9AM9 or 9AX9)	21.00

NOTES:

1. M Series key ways are backward compatible with STANDARD key ways of the same letter.
2. X Series key ways are NOT backward compatible.
3. Please contact factory for information regarding all security levels for the M and X Series. Levels 2, 3 and 4 require Masterkey Department authorization.
4. Match key keyways level to core key way level.
5. 3AM keys are available with M series keyways only

Extra Cost Options*	Option Code	Add-On
Double milling	Specific	5.60
Quadruple milling	Keyways	14.00
Long blade (IAM only)	B	5.60
No hole (2AM only)	H	3.70
Long nose (IAM only)	N	11.00
Key serialization / key	S	3.70

B Series Padlocks

Cylinders/Keys/Cores

How To Order

4IB	7	2	L			
Shackle Diameter	Core Housing	Shackle Height	Function	Chain Option	Special Stamp No.	Other Options
11B – 1/4" 21B – 5/16" 41B – 3/8"	7 – 7-pin housing; accepts all BEST cores	Steel shackle 2 – 3/4" 21 – 1" w/ shroud (21B only) 22 – 1 1/2" 72 – 2" 82 – 4" Bronze shackle 0 – 3/4" 20 – 1 1/2" 70 – 2" 80 – 4"	T – Key retained L – Non-key retained	M – Case drilled (no clevis/chain) M1* – Bronze chain M5* – Galvanized steel chain M/CR* – Clevis Only	Blank – Best logo PS1010 – "Safety First" (11B & 21B only) Specify PS# or describe stamp. Price for special stamps available upon request.	F3 – Frangible shackle (11B/20 only) O* – Lockout/tagout (OSHA) S* – Car seal (41B only) ZZ* – Double lockout (11B only) XSPL* – Cut resistant shackle WC* – Weather cover SH – Shrouded padlock w/cut resistant shackle (21B only) 606* – Satin Brass finish (brass only)

**Indicates extra cost; see the last page of B Series.
Must specify keymark and number of keys or designate L/C for less core."

Shackle Height	Shackle Code		Complete With Combined Core			Less Core
	Bronze	Stainless Steel	Patented**	Premium	Standard	
11B Series						
3/4"	0	2	213.00	213.00	194.00	92.00
1-1/2"	20	22	213.00	213.00	194.00	92.00
2"	70	72	217.00	217.00	201.00	97.00
4"	80	82	229.00	229.00	213.00	109.00
21B Series						
3/4"	0	2	215.00	215.00	199.00	95.00
1-1/2"	20	22	215.00	215.00	199.00	95.00
2"	70	72	218.00	218.00	202.00	98.00
4"	80	82	230.00	230.00	214.00	110.00
41B Series						
3/4"	0	2	217.00	217.00	201.00	97.00
1-1/2"	20	22	217.00	217.00	201.00	97.00
2"	70	72	220.00	220.00	204.00	100.00
4"	80	82	232.00	232.00	216.00	112.00
21B Series with Shroud*						
1"	N/A	21	295.00	295.00	280.00	176.00

*Pricing includes stainless steel shroud and cut-resistant shackle. Must include "SH" option when ordering.
**Patented pricing shown is for CORMAX patented keying system. Add \$20.00 for BEST Preferred patented keying.
NOTE: 626 finish is standard on brass padlock series.

Description	Catalog Number	Complete With Combined Core			Less Core
		Patented	Premium	Standard	
Cable Padlocks					
Jacketed – 24" cable	21JB7-24T	244.00	244.00	227.00	125.00
Jacketed – 36" cable	21JB7-36T	259.00	259.00	242.00	140.00
Jacketed – 48" cable	21JB7-48T	269.00	269.00	252.00	150.00
Extra cable per ft. or fraction thereof jacketed	Add-On	14.00	14.00	14.00	14.00

*Includes: padlock disassembly tool, three shackles and springs.
NOTE: Chain options are not available on cable padlocks or padlocks with shroud.

B Series Padlocks (continued)

Cylinders/Keys/Cores

Case Finish / Color Options	Option Code	Add-On*
626	626 (DEFAULT)	-
606	606	34.00
Red Powder Coat	RED	25.00
Yellow Powder Coat	YELLOW	25.00
Blue Powder Coat	BLUE	25.00
Black Powder Coat	BLACK	25.00
Orange Powder Coat	ORANGE	25.00
Green Powder Coat	GREEN	25.00

NOTE Painted logos lockset are limited to the 606 body only.

Chain Options	Option Code	Add-On
Case drilled (no clevis / chain)	M	-
Clevis with Bronze chain	M1	21.00
Clevis with Galvanized steel chain	M5	32.00
Clevis only	M/CR	9.20

NOTE Chain options are not available on cable padlocks, weather covers, or padlocks with shroud.

Other Options	Option Code	Add-On
Frangible shackle	F3	0.00
Lockout/Tagout*	O	25.00
Car Seal Slot (41B only)	S	34.00
Double lockout (11B only)	ZZ	40.00
Cut resistant shackle	XSPL	41.00
Weather cover (21B & 41B only)	WC	13.00
Shrouded padlock w/cut resistant shackle (21B only)	SH	0.00

*"O" option requires M1, M5 or M/CR chain option add-on and color choice

Accessories	Catalog Number	Price
Frangible shackle kit*	11B20FK	297.00
Frangible shackle only	11B20FF	21.00

*Includes: padlock disassembly tool, three shackles and springs.

NOTE Chain options are not available on cable padlocks, weather covers, or padlocks with shroud.

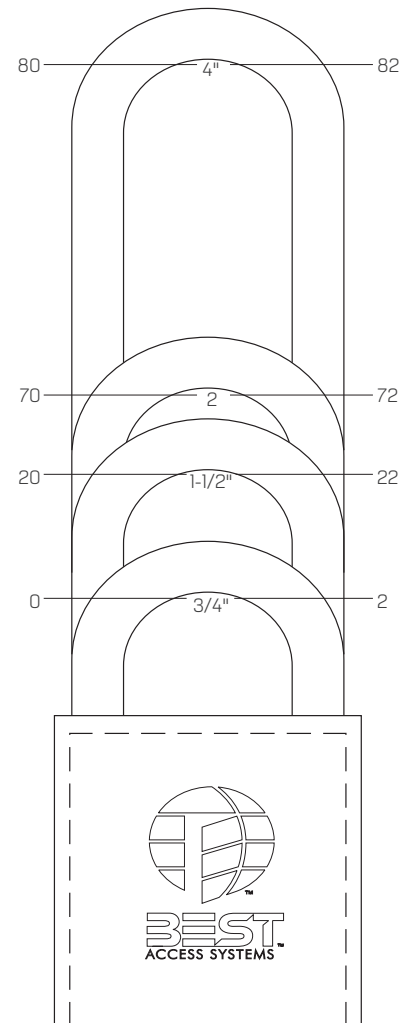

M1



M5

BEST Standard & Premium Cores

How To Order

IC	7	A	1	606	
Core Type	Core Size	Keyway	Combining Code	Options	Finish
IC – Standard	6 – 6-pin (IC only)	Designate specific keyway (A, E, etc.)	1 – Uncombined	B* – Pick & drill resistant (ICD only)	605 606
ICD – Drill resistant	7 – 7-pin		2 – Combined (B, W, P options)	K* – Key trap (IC only)	611 612
ICDP – Drill resistant Premium				P* – Pick resistant	613 625
ICP – Premium				T* – Key retained (6C & 6CP only)	626 690
2C** – Core for 8L mailbox				W* – Wear resistant	
3C – Core for 8E cylinder					
5C** – High security					
6C – Core for 4S cylinders					
6CP – Premium core for 4S cylinder					

*Indicates extra cost option, see below. **Requires long blade key and only compatible with high security mortise cylinder.
 If combined, you must specify keymark and number of keys.
 Only compatible with high security mortise cylinder

Description	Combining Code	Premium	Standard
IC & ICP Series			
Uncombined	1	73.00	66.00
Combined	2	119.00	102.00
ICD & ICDP Series			
Uncombined	1	106.00	99.00
Combined	2	152.00	135.00
2C & 3C Series			
Uncombined	1	N/A	69.00
Combined	2	N/A	104.00
5C Series			
Uncombined	1	N/A	95.00
Combined	2	N/A	122.00
6C & 6CP Series			
Uncombined	1	81.00	69.00
Combined	2	127.00	104.00

Extra Cost Options*	Option Code		Add-On
Pick &/or drill resistant	B,P	N/A	33.00
Key trap	K	N/A	15.00
Key retained	T	N/A	15.00
Wear resistant	W	N/A	15.00

Part Description	Part No.	Quantity Per Pkg.	Price Per Pkg.
Standard pin segments	A0, A1 etc.	100	18.00
Spool pin segments (Note 1)	A6, A7, etc.	100	38.00
Stainless steel segments	A0, A1, etc.	100	74.00
Core caps (500 per pkg.)	2IC	500	27.00
Core springs (500 per pkg.)	22S	500	60.00

NOTE: Standard spool pin segments are available in the following sizes: A6, A7, A8, A9, B8, B10, C3, C4, C5, C6, D6, D8, E3, E4, E5, F6, F7, & F8. (B6 spool pin segments should not be used with 5C core)

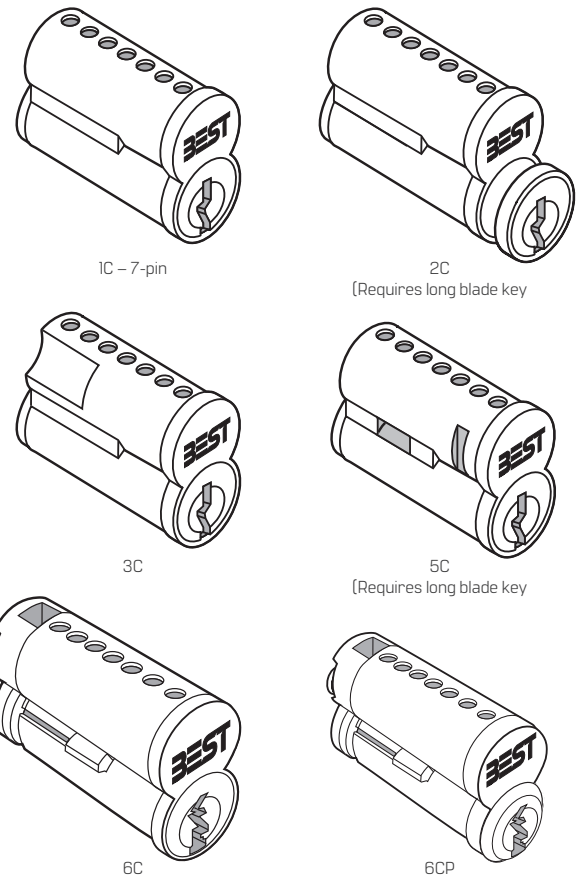

How To Order

ICB	7	B1	1	626	
Core Type	Core Size	Keyway	Combining Code	Finish	Style
ICB – 150 Series	6 – 6-pin (140 & 150 series)	B1 B6	1 – Uncombined	626 – Simulated	3840 – BEST I/C 6 pin 140 series
ICK – 140 Series	7 – 7-pin (150 series only)	B2 B7 B3 B10	2 – Combined	606 – Simulated	See the list below for other options.

*If combined, you must specify keymark and number of keys.

ICB Series Peaks Cores

Series Style	Description	Combined	Uncombined
Interchangeable Core			
3856	BEST I/C 6-pin brass 150 Series	145.00	87.00
3857	BEST I/C 7-pin brass 150 Series	145.00	87.00

ICK Series Peaks Cores

Series Style	Description	Combined	Uncombined
Interchangeable Core			
3840	BEST I/C 6-pin brass 140 Series	145.00	87.00
Conventional Cylinders (KIK = Key In Knob)			
3404	Corbin Russwin CK4200 grade, 1 knob & UT5200 unit lock	176.00	111.00
3406	Arrow, LSDA, Schlage "06" kit includes 2 security bushings, 3 faced tailpieces	176.00	111.00
3408	Sargent 7, 8 & 9 line knob	176.00	111.00
3410	Sargent Kit for 6J0, 65 line and 2000 exit device line; includes security bushing and 2 fixed tailpieces (Use A and E bottom pins only)	176.00	111.00
3454	Yale 5300 grade 2 & 5400 grade 1 knob	176.00	111.00
3455	Corbin Russwin CL3900 & Yale 5400LN grade 1 lever	176.00	111.00
3476	Sargent 7600 Integra Lock	176.00	111.00
3495	Falcon, Sargent & Weiser cyl. kit for small dia. plug faces; 3 fixed & 3 lost motion tailpiece (Use J or K bottom pins only)	176.00	111.00
3499*	Peaks Universal "99" cyl. kit includes 3 fixed & 3 lost motion tailpieces (Use J or K bottom pins only)	168.00	107.00

*The 3499 universal cylinder should be used for all Key in Knob applications except Falcon, Sargent, Weiser Locks and specialty applications listed above. Refer to the BEST Peaks Technical Manual for various KIK Tailpiece Configurations.

Removable Core			
6140	6-pin Corbin Russwin R/C	195.00	125.00
6240-6	6-pin Yale R/C	195.00	125.00
6340	6-pin Medeco R/C	195.00	125.00
6440	6-pin Schlage R/C	202.00	139.00
6540	6-pin Sargent R/C	195.00	125.00

BEST Preferred Patented Cores

How To Order

ICF	7	1P	1			626
Core Type	Core Size	Keyway	Combining Code	Style	Options	Finish
ICF – 150 Series Patented	7 – 7-pin	1P	1 – Uncombined	See list below	(150 Series only)	626** – Simulated
3CF – Core for 8E Cylinder 150 Series	(150 series only)	2P	2 – Combined	for style options	B* – Pick & drill resistant (ICDF only)	606** – Simulated
6CF – Core for 4S Cylinders 150 Series		7P			K* – Key trap	612 – Simulated
		8P			P* – Pick resistant	613 – Simulated
		9P			T* – Key retained (6CF only)	
		10P			W* – Wear resistant	
					D* – Drill Resistant	

*Indicates extra cost option, see below
 If combined, you must specify keymark and number of keys.

ICF, ICDF, 3CF and 6CF Preferred Patented Cores

Description	Combined	Uncombined
Interchangeable Core		
ICF - BEST Preferred I/C 7-pin brass 150 series	139.00	102.00
ICDF - BEST Preferred drill resistant I/C 7-pin brass 150 series	172.00	132.00
3CF - BEST Preferred I/C for 8E cylinder 7-pin brass 150 series	173.00	109.00
6CF - BEST Preferred I/C for 4S cylinder 7-pin brass 150 series	173.00	109.00

*The 3499 universal cylinder should be used for all Key in Knob applications except Falcon, Sargent, Weiser Locks and specialty applications listed above. Refer to the BEST Peaks Technical Manual for various KIK Tailpiece Configurations.

Extra Cost Options	Option Code	Add-On
Pick and/or drill resistant	B, D, P	33.00
Key Trap	K	15.00
Key Retained	T	15.00
Wear Resistant	W	15.00

BEST CORMAX™ Patented Cores

Cylinders/Keys/Cores

How To Order – M Series

ICM	7	MJ	3	1	626	
Core Type	Core Size	Keyway	Level	Combining Code	Options	Finish
ICM – CORMAX Core M Series	6 – 6-pin	MJ	1 – Non-exclusive	1 – Uncombined	B* – Pick & drill resistant (ICDM combined core only)	605 606
ICDM – CORMAX Drill resistant (M Series only)	7 – 7-pin	MK ML	2 – Two-digit zip code exclusive	2 – Combined	K* – Key trap (ICM only)	611 612 613 625
5CM** – CORMAX for High security (M Series only)		MM	3 – One digit zip code exclusive		P* – Pick resistant	626 690
6CM – CORMAX Core for 4S cylinder			4 – National exclusive		T* – Key retained (6CM only) W* – Wear resistant	

*Indicates extra cost option, see below

**Only compatible with high security mortise cylinders

If combined, you must specify keymark and number of keys.

How To Order – X Series

ICX	7	XI	W	1	626	
Core Type	Core Size	Keyway	Level	Combining Code	Options	Finish
ICX – CORMAX Core X Series	6 – 6-pin	XI.X32, etc.	W – Non-exclusive	1 – Uncombined	B* – Pick & drill resistant (ICDX combined core only)	605 606
ICDX – CORMAX Drill resistant (X Series only)	7 – 7-pin		X – Two-digit zip code exclusive	2 – Combined (B Option)	P* – Pick resistant	611 612 613 625
6CX – CORMAX Core for 4S cylinder			Y – One digit zip code exclusive Z – National exclusive		W* – Wear resistant	626 690

*Indicates extra cost option, see below

**Only compatible with high security mortise cylinder

If combined, you must specify keymark and number of keys.

Description	Combining Code	Cormax
ICM / ICX Series		
Uncombined	1	87.00
Combined	2	119.00
ICDM / ICDX Series		
Uncombined	1	120.00
Combined	2	152.00
5CM Series		
Uncombined	1	99.00
Combined	2	123.00
6CM Series		
Uncombined	1	92.00
Combined	2	120.00
6CX Series		
Uncombined	1	92.00
Combined	2	120.00

Extra Cost Options*	Option Code	Add-On
Pick &/or drill resistant	P & B	33.00
Key trap	K	15.00
Key retained	T	15.00
Wear resistant	W	15.00

Part Description	Part No.	Quantity Per Pkg.	Price Per Pkg.
Standard pin segments	A0, A1 etc.	100	18.00
Spool pin segments (Note 1)	A6, A7, etc.	100	38.00
Stainless steel segments	A0, A1, etc.	100	74.00
Core caps (500 per pkg.)	21C	500	27.00
Core springs (500 per pkg.)	22S	500	60.00

NOTE: Standard spool pin segments are available in the following sizes: A6, A7, A8, A9, B8, B10, C3, C4, C5, C6, D6, D8, E3, E4, E5, F6, F7, & F8. (B6 spool pin segments should not be used with 5C core.)

NOTES

1: M Series key ways are backward compatible with Standard key ways of the same letter.

2: X Series key ways are NOT backward compatible.

3: Please contact factory for information regarding all security levels for the M and X Series. Levels 2, 3 and 4 require Masterkey Department authorization.

4: Match key keyways level to core key way level.

D Series Service Equipment

Auxiliary Locks

The security items in this series are available only to registered BEST Masterkey System owners. The restriction is for the purpose of avoiding proliferation of equipment that could be used to compromise the security of such systems.

Description	Catalog No.	Price
AD Series - Key Equipment		
Key combinator (Standard & CORMAX)	AD433*	7,954.00
Key combinator—Premium	AD433P*	9,133.00
Key carriage (Standard & CORMAX M Series keyways)	AD434	1,242.00
Key carriage—Premium	AD434P	1,036.00
Key combinator system conversion	Call to Order	1,031.00
Key cut indicator (in CD431 Kit)	AD501*	63.00
Key calibrator (mechanical)	AD502	1,279.00
Key calibrator (digital)	AD502D	3,274.00
Key stamping plate (55 standard keys)	AD504A	2,819.00
BD Series - Padlock Equipment		
Assembly kit complete	BD640	670.00
Tweezers—6" (in BD640 Kit)	BD641	44.00
Shackle plug tool (in BD640 Kit)	BD642	482.00
Holding plate (in BD640 Kit)	BD643	160.00
Rivet flaring tool	BD650	407.00
Storage hook (41B & 61B)	BD651	33.00
Padlock disassembly tool (11B, 21B, 41B)	BD654	287.00
Lockout	BD655	38.00
Lockout ties (pkg. of 50)	BD656A	59.00
Corrosion free lubricant - 2 oz Squeeze Bottle	BD670	63.00
Corrosion free lubricant - 28.74 oz Refill	BD680	135.00
CD Series - Core Equipment		
Combining kit complete	CD431*	1,587.00
Combining bin	CD433	639.00
Stamping plate—face only (87 cores)	CD504B	2,819.00
Stamping plate—side only (50 cores)	CD504C	2,819.00
Core capping / decapping press	CD517	4,278.00
Graphite gun	CD535	55.00
Graphite—1 lb. container	CD535A	90.00
Capping / decapping block for IC 150 (in CD431 Kit)	CD540	324.00
Hand capping pin for use with capping block (in CD431 Kit)	CD547	45.00
Ejector pin (in CD431 Kit)	CD548	33.00
Tweezers—3" (in CD431 Kit)	CD549	9.90
Combining bin kit	CD435	3,194.00
DD Series - Combining Equipment		
Letter dies—1/16" or 3/32"	DD502	407.00
Number dies—1/16" or 3/32"	DD503	145.00
Core / key marking block (1 core & key)	DD513	324.00
Core / key marking plate (5 cores & 10 keys)	DD514	828.00
Magnetic strip (2 ea. in DD514)	DD514A	8.20
Combining hammer with plastic head	DD550	199.00
Plastic heads (for DD550)	DD551	63.00

*Specify A2, A3 or A4 keying system

Description	Catalog No.	Price
ED Series - Cylinder Equipment		
Mortise cylinder wrench	ED211	75.00
Mortise cylinder assembly tool	ED212	129.00
Thread repair die 1E cylinder	ED221	882.00
Cylinder cam testing tool	ED222	79.00
3E Cylinder hole tap	ED224	761.00
1E Cylinder hole tap	ED225	761.00
Eurocylinder wrench	ED801	264.00
5E Combining kit complete (Note 1)	5ED250	1,698.00
5E Thread tap—3/4" x 24	5ED253	344.00
5E Capping block (in 5ED250 Kit)	5ED261	501.00
5E Cap depressor (in 5ED250 Kit)	5ED262	142.00
KA Series - Door Adaptor Kits		
Mortise to cylindrical 1" faceplate	62KA2A	148.00
Mortise to cylindrical 1-1/8" faceplate	83KA2A	152.00
Wrap-around 2-3/8" backset (160)	62KA2B	148.00
Wrap-around 2-3/4" backset (161)	83KA2B	152.00
KD Series - Cylindrical/Tubular Equipment		
9K Throughbolt drill jig	KD303	15.00
Boring jig kit complete	KD304A	1,896.00
2-1/8" spur drill bit	KD309	639.00
Faceplate marking chisel (160)	KD312	177.00
Faceplate marking chisel (161) 1-1/8"	KD315	177.00
8K Spanner wrench	KD316	15.00
9K Spanner wrench	KD317	15.00
1" auger bit	KD318	145.00
Strike plate locating pin	KD325	63.00
Return spring loading tool	KD340	123.00
Knob Adaptation Cut-Off Fixtures For:		
Schlage D Series	KD352S	332.00
Yale #5400	KD351Y	332.00

NOTES:

1. Specify A2, A3 or A4 keying system.

2. Specify door thickness (630 finish only).

D Series Service Equipment (continued)

Auxiliary Locks

The security items in this series are available only to registered BEST Masterkey System owners. The restriction is for the purpose of avoiding proliferation of equipment that could be used to compromise the security of such systems.

Description	Catalog No.	Price
140 Series Bottom Pins		
A2 Bottom pins (except for 6140, 6440, & 6540 RC, and KIK cylinders)	A2A0 thru A2A9	33.00
A2 Bottom pins for 6140 & 6540 RC, and KIK cylinders	A2J0 thru A2J9	33.00
A4 Bottom pins (except for 6140, 6440, & 6540 RC, and KIK cylinders)	A4E0 thru A4E5	33.00
A4 Bottom pins for 6140 & 6540 RC, and KIK cylinders	A4K0 thru A4K5	33.00
A2 Bottom pins for 6440 removable cores	A2X0 thru A2X9	33.00
140 Series Top Pins		
A2 Top pins for all products (except 6440 removable core)	Use BEST top pins (see page 20)	N/A
A4 Top pins for all products (except 6440 removable core)	Use BEST top pins (see page 20)	N/A
A2 Top pins for 6440 removable core	A2W2 thru A2W19	33.00
Patent Top & Bottom Pins		
Patent top pins for all IC and RC cylinders	PT1	85.00
Patent top pins for KIK cylinders	PT2	85.00
Patent bottom pins (except for 6140, 6440, & 6540 RC, and KIK cylinders)	PB1	85.00
Patent bottom pins for 6140 & 6540 RC, and KIK cylinders	PB2	85.00
Timing Pins		
Timing pin for 6340 and 6540 RC cylinders	TP6312	86.00
Segment Springs		
Springs for all products except Schlage 6440 RC	SS4220	115.00
Springs for Schlage 6440 RC	SS4010	115.00
Spring Slide Covers		
Spring cover for all KIK cylinders and 6440 RC	SC2000	86.00
Spring cover for 6140 & 6240 RC, mortise, and rim cylinders	SC2005	86.00
Spring cover for 6340 and 6540 RC cylinders	SC2001	86.00
Caps for 3840 IC core	Use BEST 2IC caps (see page 20)	N/A
Capping Tools		
Staking fixture for KIK, mortise, and rim cylinders	CD4000	845.00
Staking fixture for IC, and all RC cylinders (except 6440 RC)	CD6840	845.00
Staking tool for KIK, and all RC cylinders (except 6440 RC)	CD4001	399.00
Staking fixture for 6440 RC cylinder	CD6440	426.00
Staking tool for 6440 RC cylinder	CD6401	399.00
Plug follower	LT370	73.00
140 & 150 key gage for both A2 and A4	AD4050	112.00
Pin Kits		
Peaks universal A2 pin kit complete (Manufactured by KABA)	CD5012	2,140.00
Peaks universal A4 pin kit complete (Manufactured by KABA)	CD5004	2,140.00
Peaks Schlage 6440 RC A2 pin kit complete (Manufactured by KABA)	CD5002	2,140.00
AD Series - Key Equipment (You must purchase directly from BEST)		
Key combinator - Peaks® 6-pin	AD436*	9,687.00
Key combinator - Peaks® 7-pin	AD437*	9,687.00
Key carriage - Peaks® 6-pin	AD436K	1,610.00
Key carriage - Peaks® 7-pin	AD437K	1,610.00
Capping Tools (You must purchase directly from BEST)		
140 Series IC Capper/Decapper press	CD517P	4,213.00
140 IC Capping block only (order CD540 for 150 IC)	CD540P	320.00
140 & 150 Key cut indicator (Peaks equipment)	AD4050	112.00
140 & 150 IC Capping tool (for use with capping block)	CD547	45.00

All 140 series keys and 150 series keys using B3 through B6 keyways require a key milling machine.

*Specify A2 or A4 keying system.

KRD Series Key Retaining Devices

How To Order

KRD-2	UL-KRD-2	S
Device type	Part number	Option

Description	Catalog number	Price
BEST core models		
KRD-2 BEST Core Model	UL-KRD-2	710.00
KRD-2H Hybrid (Sargent/BEST Model)	UL-KRD-2H SAR/BEST	811.00
KRD-2H Hybrid (BEST/Schlage FSIC Model)	UL-KRD-2H BEST/SCH	811.00
KRD-3 BEST Core Dual Function Model	UL-KRD-3	1,048.00
Non-BEST Full size core models		
KRD-2 Corbin Russwin 6-pin IC	UL-CR6-KRD-2	811.00
KRD-2 Corbin Russwin 7-pin IC	UL-CR7-KRD-2	811.00
KRD-2 Medeco IC	UL-MED-KRD-2	811.00
KRD-2 Sargent RC	UL-SAR-KRD-2	811.00
KRD-2 Schlage FSIC	UL-SCH-KRD-2	811.00
KRD-2 Yale 6-pin IC	UL-YA6-KRD-2	811.00
KRD-2 Yale 7-pin IC	UL-YA7-KRD-2	811.00

Extra Cost Options*	Option Code	Add-On
Switch	S	253.00
Security seal	SS	229.00

*Add option code to part number shown above.

QU-I.C-SYSTEM Combining Tool Packages

Auxiliary Locks

How To Order

BQDP		A2	7	Example: GM 8301836 CTL 4189250
Package description		System Type	Core size	System Code Information REQUIREMENT
Dedicated	BQDP – Basic QU-I.C-KEY Dedicated Package	A2 – A2 System	6 – 6-pin	YES System Grand Master and Control codes must be supplied
	PQDP – Professional QU-I.C-KEY Dedicated Package	A4 – A4 System	7 – 7-pin	
Universal	BQUP – Basic QU-I.C-KEY Universal Package	A2 – A2 System	6 – 6-pin	NO Code information is not necessary.
	PQUP – Professional QU-I.C-KEY Universal Package	A4 – A4 System	7 – 7-pin	

Description	Catalog No.	Price
Dedicated Packages		
These QU-I.C-KEYS are permanently factory built specifically for just one key system. Grand master & Control codes are required. These tools are intended for long-term use by Institutional Locksmiths and others who continuously work with the same key system[s].		
Basic dedicated package, includes: QKD, QLT-6 or QLT-7, QTT, OCT, QTJ, and OPT (see individual components listed below).	BQDP-A2/A4-pin/GM & CTL *	2,745.00
Professional dedicated package, includes all components in the basic package, plus QTA, QPP and CKT-80 (see individual components listed below).	PQDP-A2/A4-pin/GM & CTL *	3,434.00
Universal Packages		
Using a blank QU-I.C-KEY and code strips, you get to custom build a QU-I.C-KEY for any A2 key system that you are working with. These kits are better suited for temporary use and re-use - not for longer term of continuous key system use. A4 System kits are also available.		
Basic universal package, includes: QKD, QLT-6 or QLT-7, QTT, OCT, QTJ, and OPT (see individual components listed below).	BQUP-A2/A4-pin *	3,438.00
Professional universal package, includes all components in the basic package, plus QPP, QTA and CKT-80 (see individual components listed below).	PQUP-A2/A4-pin *	4,118.00
Individual Components		
Dedicated QU-I.C-KEY with viewing base (system information required)	QKD-A2/A4-pin/GM & CTL	888.00
Dedicated QU-I.C-KEY tool only (system information required)	QKDT-A2/A4-pin/GM & CTL	672.00
Universal QU-I.C-KEY with viewing base (specify A2 or A4 system)	QKU-A2/A4	1,639.00
QU-I.C-LOAD tool (specify 6 or 7-pin cores)	QLT-6 * or QLT-7 *	685.00
QU-I.C-TEST tool	QTT *	940.00
QU-I.C-CHEX Tool	OCT *	161.00
QU-I.C-Tweez-jector	QTJ	257.00
QU-I.C-Preamer	OPT	217.00
QU-I.C-Power preamer	QPP	161.00
QU-I.C-TEST Adapter (must be used with QTT)	QTA	363.00
12 Position Core & key tray	CKT-12	312.00
80 Position Core & key tray	CKT-80	641.00

*Not compatible with the special I40 Series.

E Series Cylinders

How To Order

IE	7	4	C4	RP3	626	
Series	Core Housing	Function Code	Length Code	Cam or Spindle	Rings	Finish
See Below***	0 – Dummy 6 – 6-pin 7 – 7-pin housing; accepts all BEST cores	See below	Blank – Standard 22 – 1-3/8" 24* – 1-1/2" up to 6" (See length code below)	C4 – Standard cam C181 – Adams Rite MS cam S2 – Standard spindle For a complete list of cams, see the next page.	RP – Rim cylinder RP1 – Tapered cylinder RP2 – 6-pin mortise RP3 – 7-pin mortise RP4 – 3E mortise RP5 – 7-pin mortise For special rings, see the catalog.	626 690 622 Satin* 606 612 613 619 Bright* 605 611 625

*Indicates extra cost; see below.

Must specify keymark and number of keys or designate L/C for less core.

***IE Special Lengths only available on IE4 7-Pin

Series/Description	Function or Length Code	Complete With Combined Core			Less Core
		Patented*	Premium	Standard	
1-5/32" Diameter Cylinders					
IEE Standard rim	2	218.00	218.00	201.00	99.00
Dummy Rim	2	N/A	N/A	N/A	51.00
IE Standard mortise	4	230.00	230.00	213.00	111.00
Tapered mortise	6	230.00	230.00	213.00	111.00
Dummy / mortise (0-pin)	04	N/A	N/A	N/A	64.00
IEA STD Turn knob-rim / ADA mortise (6-pin**)	A2/A4	N/A	N/A	N/A	84.00
ADA Turn knob-rim (6-pin**)	A1	N/A	N/A	N/A	159.00
IEB Rim / mortise with dust cover	B2/B4	287.00	287.00	270.00	168.00
IEC Square head mortise	C4	287.00	287.00	270.00	168.00
IED Slabbed direct motion (7-pin**)	D4	287.00	287.00	270.00	168.00
IEE Slabbed lost motion (7-pin**) (Specify RH or LH hand.)	E4	287.00	287.00	270.00	168.00
IEF Standard lost motion (Note 1)	F4	287.00	287.00	270.00	168.00
IEG Hotel shifting cam	G4	287.00	287.00	270.00	168.00
IEJ High security—UL-listed (7-pin**)	J4	422.00	N/A	405.00	N/A
IEK High security—Non-UL (7-pin**)	K4	404.00	N/A	387.00	285.00
IE Series Special Length Mortise Cylinders					
1-3/8"	22	267.00	267.00	250.00	148.00
Each additional 1/8" (1-1/2" to 6") See catalog for lengths available.	24 to 96*	7.30	7.30	7.30	7.30
3E Series					
Mortise-1-1/2" diameter (7-pin**)	4	287.00	287.00	270.00	168.00

*Patented pricing shown is for CORMAX patented keying. Add \$20.00 for BEST Preferred patented keying.

**Only Standard and CORMAX M Series keying available on IEJ and IEK cylinders.

Length Code	Cylinder Length
22	1-3/8"
24	1-1/2"
26	1-5/8"
28	1-3/4"
30	1-7/8"
32	2"
34	2-1/8"
36	2-1/4"
40	2-1/2"
44	2-3/4"
48	3"
56	3-1/2"
64	4"
72	4-1/2"
80	5"
88	5-1/2"
92	5-3/4"
94	5-7/8"
96	6"

*Extra Cost Option	Add-On
Satin finish—606, 612, 613, etc.	6.00
Bright finish—605, 611, 625, etc.	8.20

Part Description	Part Number	Part Price	With Lock Add-On
Standard rings	IER2, 3, 5	6.50	0.00
Straight rings (Specify lengths.)	IER7	26.00	9.70
Tapered rings (Specify lengths.)	IER8	32.00	25.00
Security rings (Specify lengths.)	IESR	97.00	0.00
Spindles	IES2, 3	6.50	0.00
Hex nut for IE	A00836	6.00	0.00
Standard throw pins	A40095	1.70	0.00
Throw pins—Adams Rite MS Cam	A20924	1.70	0.00

NOTE 1: Specify stop pin right or left of cam from back view.

E Series Cylinders (continued)

Auxiliary Locks

Use the following table to determine the kinds of cams available for IE, 3E and 5E cylinders.

Cams Listing

Cam Type	Cams by Cylinder Type											
	IE Cyl				3E Cyl		5E Cyl					
Cabinet	C224	C225	C228							C2A	C245	
	C229	C235	C238	C241						C4A	C3	
	C246	C248	C249	C250						C2B	C4B	
	C253	C500 thru C509 (C500, C501, C502, etc)									A10281	
	A04607	A08854	A10281	A14154						A21198	A26344	
Cloverleaf	C118	C161	C204	C222				C118	C161			
	C243	C254	C256	C258								
	C265	C281										
Roller	C142	C221	C227					A04533				
	C240	C251	A04533									
Straight	C101	C103	C110	C115	C121	C123	C124			C127	C136	
	C127	C128	C129	C130	C131	C134	C136			C208	C210	
	C137	C143	C148	C152	C162	C165	C169			C3	C4	
	C171	C173	C177	C178	C179	C181	C182					
	C185	C186	C187	C191	C193	C200	C203					
	C208	C209	C210	C211	C220	C223	C226					
	C231	C233	C234	C239	C242	C247	C252					
	C4											
Thumbturn	C140	C410 thru (C401, C402, etc)										
Two-point	C102	C114										

Consult factory for pricing on cams.

5E and 8E Series Utility Cylinders (Cam Locks)

Auxiliary Locks

How To Order

5E	7	A	1	C	R708	4B	21	12	R	90	626
Series	Lock Body	Keyway	Combining Code	Cam Motion	Ring Length	Cam Type*	Cam Length	Mounting Position	Cam Direction	Degree of Rotation	Finish
5E – 3/4"	6 – 6-pin 7 – 7-pin	Designate specific keyway (A, E, etc.)**	1 – Uncombined 2 – Combined	A – Direct B – Limited C – Lost motion D – Throw member drive	R701 – 1/16" R702 – 1/8" R703 – 3/16" R704 – 1/4" R705 – 5/16" R706 – 3/8" R707 – 7/16" R708 – 1/2" etc.	1 – Fixed Straight 2A – Fixed offset in 2B – Fixed offset out 3 – Lost motion 4A – Lost motion offset in 4B – Lost motion offset out D – Direct throw member	10 – 5/8" 12 – 3/4" 14 – 7/8" 16 – 1" and so forth in 1/8ths of an inch	3 – 3 o'clock 6 – 6 o'clock 9 – 9 o'clock 12 – 12 o'clock	R – Right L – Left	90 – 90° 180 – 180° 360 – 360°	626 Std

*See the previous page for other compatible 5E cams.
If combined, you must specify keymark and number of keys.
**5E cylinders available in Standard and Premium keyways only.

Description	Combining Code	Price Complete
5E–Uncombined	1	107.00
5E–Combined	2	142.00

Part Description	Part Number	Part Price
Cams	5EC1, etc.	21.00
Slide cap–6-pin	5ECP6	2.30
Slide cap–7-pin	5ECP7	2.30
Cam screws	5ECS	4.00
Hex nut 3/4"	5EH	7.30
Cam screw lock washer	5ELW	4.00
Rings [Specify length.]	5ER7	10.00
Springs [box of 500]	5ES1	62.00
Lock body washer	5EW	4.00

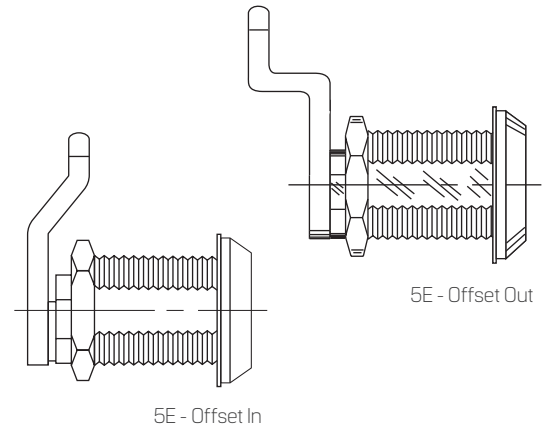

Description	Catalog Number	Complete With Combined Core			Less Core
		Patented*	Premium	Standard	
8E Series Eurocylinders					
Single cylinder–elliptical***	8EA7A5	N/A	N/A	252.00	148.00
Double cylinder–elliptical***	8EA7A6	N/A	N/A	386.00	178.00
Single cylinder–profile****	8EE7E4	N/A	N/A	387.00	283.00
Double cylinder–profile****	8EE7E5	N/A	N/A	513.00	305.00
Cylinder x turn knob–profile****	8EE7E8	N/A	N/A	535.00	433.00
Union single cylinder*****	8EH7H5	354.00	354.00	337.00	235.00
Union double cylinder*****	8EH7H6	536.00	536.00	502.00	298.00
Union cylinder x turn knob*****	8EH7H7	382.00	382.00	365.00	263.00
Union cylinder x lever turn*****	8EH7H8	477.00	477.00	460.00	358.00

*To order 8EE7E5, you must specify the ring length and critical dimensions. Refer to the catalog section "Cylinders."

**Patented pricing shown is for CORMAX patented keying system. Add \$20.00 for BEST preferred patented keying.

***Available in 605,606,619,625,626 finishes

****Available in 606,613,619,626 finishes

*****Available in 606,625,626 finishes

ATTENTION: Locksets that secure both sides of the door are controlled by building codes and the Life Safety Code. Delay in unlocking for rapid emergency exit could be hazardous or even fatal.

Description	Product Number	List Price
Keystone Web - New License	KSWN	6,293.00
Keystone Web - Upgrade (For existing users with Keystone 600 software)	KSWUP	3,148.00

Description	Product Number	List Price
Importing code files for entire masterkey system: 1-5 files	IMPKSW-1	1,262.00
Importing code files for entire masterkey system: 6-10 files	IMPKSW-1A	2,145.40
Importing code files for entire masterkey system: 11-15 files	IMPKSW-1B	3,647.18
Importing code files for entire masterkey system: 16 or more files	IMPKSW-1C	6,200.21
Additions Import * - Importing code files for additions to systems existing within customer's Keystone Web (system additions of less than 10 masters)	IMPKSW-2	318.00

*Any additions import consisting of more than 10 masters will require IMPKSW-1
 Every import order must be accompanied by an import order form. The import form is located on bestaccess.com under Keystone web resources or ask your dormakaba USA sales representatives for a copy.

NOTES: Keystone Web software will support both network and standalone installations
 Keystone Web comes without any information loaded. Code Import files have to be ordered to import code data
 For existing customers, migration tool is included with the software to migrate data into the new application during upgrade.
 There is no additional charge for migrating existing user data in older version of Keystone to Keystone Web.
 All orders will require following information: End User Company/Facility Name, End User Name, End User Email.

45H Series Mortise Locks

Mortise Locks

Federal Spec. 86

ANSI Series 1000

How To Order

45H	7	R	14	H	626	RH	
Series	Core Housing	Function Code	Lever Style	Trim Style	Finish	Door Hand	Options
45H – Standard mortise lock	0** – Less cylinder (non-keyed or dummy trim) 7 – 7-pin housing accepts all BEST cores	A – Office D – Storeroom L – Privacy N – Passage R – Classroom SV – Security vestibule* T – Dormitory etc. See below	3 – Solid tube/return 12* – Solid tube/no return 14 – Curved/return 15 – Contour/angle return 16 – Curved/no return 17R* – Gull wing RH 17L* – Gull wing LH Knobs: 4 – Round Decorative* OEM**** - Service (less lever)**	H – 2-3/4" dia R – 2-3/4" dia S – 3-1/2" dia J* – wrought M* – forged N* – forged (concealed cylinder; N trim invalid on non-keyed and double keyed functions)	618 626 630*** 690 622 626AM* 630AM* Satin* 606 612 613 619 Bright* 605 611 625 629***	RH RHR LH LHR	7/8** – 7/8" lip-to-center strike LL* – Lead lined SH* – Security head screws Thick Door* – Specify thickness if other than 1-3/4" TAC/B* – Tactile both levers/knobs TAC/O* – Tactile outside lever/knob TAC/I* – Tactile inside lever/knob VIN* – Visual Keyed Indicator Option VIT* – Visual Thumb-Turn Indicator Option VIB* – Double Visual Indicator Option VT* – Vandal Trim WS – Windstorm Label (Florida Building Code)

*Indicates extra cost option

**Indicates cost deduction. Must specify keymark and number of keys or designate L/C for less core.

3 - no options available for SV function

NOTE: VIN option only compatible with H, R and J trim styles

VIT options only compatible with H, R, S, J & M trim styles

VIB option only compatible with H, R & J trim styles

OEM option is only compatible with H, R and S Trim Styles.

Decorative levers are considered special order items that may have extended lead times. Consult factory for lead times.

Available decorative levers: 50-53, 55, 60, 62-63, 65, 69, 75, 79-81, and 89

Universal locks can only be ordered with sectional (rose) trim. If escutcheon (J/M/N) trim is needed, order a three-part lock.

Function Description	Function Code	Complete With Combined Core			Less Core
		Patented*	Premium	Standard	
Single Keyed:					
Latch	A, AT, D, R	1,436.00	1,436.00	1,419.00	1,317.00
Deadbolt	AB, B, BA, BW, T, TA, TD	1,476.00	1,476.00	1,459.00	1,357.00
Holdback	RHB	1,460.00	1,460.00	1,443.00	1,341.00
Hotel	H, HJ	N/A	N/A	1,625.00	1,523.00
Deadlock	AD, YD	652.00	652.00	635.00	533.00
Deadlock-Classroom	RD	731.00	731.00	714.00	612.00
Double Keyed:					
Latch	C, INL, W	1,672.00	1,672.00	1,638.00	1,434.00
Deadbolt	G, IND, S, INA	1,717.00	1,717.00	1,683.00	1,479.00
Holdback	CHB	1,717.00	1,717.00	1,683.00	1,479.00
Deadlock	WD	886.00	886.00	852.00	648.00
Keyless:					
Passage	N	N/A	N/A	N/A	1,042.00
Privacy (Latch)	LT	N/A	N/A	N/A	1,197.00
Privacy (Deadbolt)	L, LB	N/A	N/A	N/A	1,232.00
Exit	NX	N/A	N/A	N/A	1,197.00
Single Dummy	1DT	N/A	N/A	N/A	454.00
Double Dummy	2DT	N/A	N/A	N/A	802.00
Universal Functions					
Latch	UNR**	1,434.00	1,434.00	1,417.00	1,315.00
Deadbolt	UNT, UNAB**	1,460.00	1,460.00	1,443.00	1,341.00
Other Functions					
Security Vestibule (see important below)	SV	2,039.00	2,039.00	1,976.00	1,735.00

*Patented pricing show is for CORMAX patented keying. Add \$20.00 for BEST Preferred patented keying.

** Not available on #17 levers.

Price includes lock case, faceplate and strike package. Refer to 45H for complete mortise cylinder pricing.

NOTE: 47H Series must be keyed at the factory unless the K option is ordered.

IMPORTANT: Openings utilizing the Security Vestibule function do not allow for free egress, potentially causing a life safety issue in the event of an emergency. Installation should be in accordance with all local building codes and in locations where there are accessible means of free egress.

45H Series Mortise Locks (continued)

Mortise Locks

Extra Cost Options*	Option Code	Per Lock
Satin finishes (per lock)	606, 612, 613, 619 etc.	50.00
Bright finishes (per lock)	605, 611, 625, etc.	89.00
UltraShield antimicrobial finish	626AM, 630AM	94.00
Wrought trim	J	22.00
Thick door	Specify thickness	127.00
Tactile both levers/knobs**	TAC/B	177.00
Tactile outside lever/knob**	TAC/O	94.00
Tactile inside lever/knob**	TAC/I	94.00
Lead lined	LL	340.00
Forged trim	M, N	142.00
Security head screws	SH	35.00
7/8" Lip-to-center strike	7/8 LTC	35.00
Vandal trim - 630 finish***	VT	218.00
Vandal trim - other finishes***	VT	169.00
Visual Indicator****	VIN	67.00
Visual Indicator Thumb-Turn	VIT	103.00
Double Visual Indicator	VIB	168.00
12, 17 Lever Design	12, 17	100.00
Decorative Lever Design	50 to 91	309.00

Cost Deductions**	Option Code	Deduct
Less cylinder option (Deduct from complete price)	0	81.00
OEM - Service (Less lever/trim)*****	OEM	28.00

*Indicates extra cost option.

**Not available on #17 levers.

***Available only with #14 and #15 levers. Only #14 lever complies with California State Fire Marshal Code.

****VIN option only compatible with H, R and J Trim Styles.===

*****PRODUCT NOTE: The BHMA listed lock with trim from another manufacturer in this price book is not being offered as a BHMA listed product. We cannot ensure the compatibility of our lock with any third party product and such products have not been tested as a combined unit. Please see BEST warranty for further details.

47H Series High Security Mortise Lock

Mortise Locks

Federal Spec. 86

ANSI Series 1000

How To Order

Series	Core Housing	Function Code	Lever Style	Trim Style	Finish	Door Hand	Options
47H – Lever/ Knob – High Security mortise lock	7 – 7-pin housing accepts 5C core only	A – Office D – Storeroom R – Classroom T – Dormitory etc.	Levers: 3 – Solid tube/return 12* – Solid tube/no return 14 – Curved/return 15 – Contour/angle return 16 – Curved/no return 17* – Gull wing Knobs: 4 – Round Decorative* 50–91	H*** – 2-3/4" dia R*** – 2-3/4" dia S*** – 3-1/2" dia M – Forged	626 630 626AM* 630AM*	RH RHR LH LHR	7/8" – 7/8" Lip-to-center strike K – Non UL cylinder LL* – Lead lined TAC/B* – Tactile both levers/knobs TAC/O* – Tactile outside lever/knob TAC/I* – Tactile inside lever/knob Thick Door* – specify thickness if other than 1-3/4" VT* – Vandal Trim WS – Windstorm Label (Florida Building Code)

EXTRA COST OPTIONS* See 45H section.

**Indicates cost deduction, see 45H section. Must specify keymark and number of keys.

***To maintain the UL437 standard for high security locks, order only M trim. Using H, R or S trim does not meet the UL437 standard.

Function Description	Function Code	Patented*	Standard
Single Keyed:			
Latch	A, AT, D, R	1747.00	1746.00
Deadbolt	AB, B, BABW, T, TA, TD	1798.00	1797.00
Deadlock	AD, YD	1088.00	1087.00
Deadlock-Classroom	RD	1173.00	1172.00
Double Keyed:			
Latch	C, INL, W	2127.00	2125.00
Deadbolt	G, IND, S, INA	2188.00	2186.00
Deadlock	WD	1488.00	1486.00

*Patented pricing shown is for CORMAX M Series patented keying system only. Add \$20.00 for BEST Preferred Keying.

48H and 49H Series Mortise Deadlocks

Mortise Locks

How To Order

48H	7	K	626	
Series	Core Housing	Function Code	Finish	Options
48H – Standard 49H** – High security	0 – Less cylinder (48H only) 7 – 7-pin housing 48H accepts all BEST cores 49H accepts 5C core only	See below	622 626 690 626AM* Satin* 606 612 613 619 Bright* 605 611 618 625 49H 626 only	K – IE7K4 high security cylinder (non UL) for 49H only LL* – Lead lined SH* – Security head screws Thick Door* – Specify thickness if other than 1-3/4" WS – Windstorm Label (Florida Building Code)

*Indicates extra cost option; see below.

**49H is keyed at the factory unless the K option is ordered.

NOTE: Must specify keymark and number of keys or designate L/C for less core.
 Security Head screws provided standard on 49H.

Function Description	Function Code	Patented*	Premium	Standard	Less Core
48H Series					
Single cylinder	K, L	646.00	646.00	629.00	527.00
Single cylinder - Classroom	R**	722.00	722.00	705.00	603.00
Double cylinder	M	874.00	874.00	840.00	636.00
49H Series					
Single cylinder	K, L	1215.00	N/A	1214.00	N/A
Single cylinder-Classroom	R**	1298.00	N/A	1297.00	N/A
Double cylinder	M	1456.00	N/A	1455.00	N/A

*Patented pricing shown is for CORMAX M Series patented keying system only. Add \$20.00 for BEST Preferred Keying.

For 49H, pricing reflects the 5C high security core for standard and the 5CM high security CORMAX core for patented.

**Handing (LH or RH) must be specified when ordering a "R" function. Indicate "LH" for LH/LHR door handing and "RH" for RH/RHR door handing.

Extra Cost Options*	Option Code	Add-On
Satin finishes	606, 612, 613, etc.	50.00
Bright finishes	605, 611, 625, etc.	89.00
UltraShield antimicrobial finish	626AM, 630AM	94.00
Security head screws (48H)	SH	35.00
Thick door (48H only)	Specify thickness	127.00
Lead lined	LL	340.00

40H Series Mortise Components

Mortise Locks

Federal Spec. 86

ANSI Series 1000

How To Order - Case Only

Series	Function Code	Finish	Options
45HCA - Mortise lock case only	A - Office D - Storeroom R - Classroom T - Dormitory etc.	626 630 622 690 626AM* 630AM*	SH* - Security head screws 7/8** - 7/8" Lip-to-center strike (Handling): RH LH RHR LHR
		Satin* 606 612 613 619 618	
		Bright* 605 611 625 629	

*Indicates extra cost option.

45HCA Case Only:

Function Description	Function Code	Price
Single Keyed:		
Latch	A, AT, D, R	564.00
Deadbolt	AB, B, BA, BW, T, TA, TD	611.00
Holdback	RHB	574.00
Hotel	H, HJ	611.00
Deadlock	AD, YD	391.00
Deadlock-Classroom	RD	356.00
Double Keyed:		
Latch	C, INL, W	564.00
Deadbolt	G, IND, S, INA	611.00
Holdback	CHB	574.00
Deadlock	WD	391.00
Keyless		
Passage	N	440.00
Privacy (Latch)	LT	564.00
Privacy (Deadbolt)	L, LB	611.00
Exit	NX	564.00
Universal Functions		
Latch	UNR	564.00
Deadbolt	UNT, UNAB	611.00

Price includes lock case, faceplate and strike package. Refer to 45H for complete mortise cylinder pricing.

Vandal Trim Retrofit Kit

Series	Lever Style	Finish	Options
45HVTK - Vandal Trim Kit	14* - curved return 15 - contour / angle return	605, 606, 611, 612, 613, 618, 619, 622, 625, 626, 629, 630, 690	Thick door (specify thickness if other than 1-3/4")

*Indicates extra cost option.

How To Order - Trim Kits

Series	Function Code	Knob/Lever Style	Trim Style	Finish	Options
40HTK - Trim Kit	IS1 - inside lever only IS2 - inside lever x turn IS3 - inside lever x cyl IS4 - inside cyl only IS5 - inside turn only*** IS6 - inside lever x cylinder x visual indicator OS1 - outside lever only OS2 - outside lever x cyl OS3 - outside lever / emergency plate OS4 - outside cyl only OS5 - outside lever x visual indicator OS6 - outside lever x cylinder x visual indicator	Levers: 3 - solid tube / return 12* - Solid tube / no return 14 - curved return 15 - contour / angle return 16 - curve / no return 17 - RH* 17 - LH* 50 - 91 - Decorative* Knobs: 4 - round	H - 2-3/8" dia R - 2-3/4" dia S - 3-1/2" dia J* - wrought M* - forged N* - forged (concealed cylinder)	605* 606* 611* 612* 613* 618* 619* 622 625* 626 629 630 690 626AM* 630AM*	Thick Door* (specify thickness if other than 1 3/4") SH* - Security head screws TAC/O* - Tactile outside lever / knob TAC/I* - Tactile inside lever / knob

***Does not include lever - Unavailable with J trim.

Trim Only:

Kit Number	Price
IS1 - Inside lever only	312.00
IS2 - Inside lever x turn	411.00
IS3 - Inside lever x cylinder	445.00
IS4 - Inside cylinder only	127.00
IS5 - Inside turn only	111.00
IS6 - Inside lever x cylinder x visual indicator	512.00
OS1 - Outside lever only	347.00
OS2 - Outside lever x cylinder	461.00
OS3 - Outside lever x emergency plate	365.00
OS4 - Outside cylinder only	127.00
OS5 - Outside lever x Visual Indicator	414.00
OS6 - Outside lever x cylinder x visual indicator	528.00

Extra Cost Options*

Option Code	Price
Satin finishes	606, 612, 613, etc. 50.00
Bright finishes	605, 611, 625, etc. 89.00
UltraShield antimicrobial finish	626AM, 630AM 94.00
J Trim	J 22.00
Forged trim	M, N 142.00
Thick Door	Specify Thickness 127.00
Security head screws	SH 35.00
7/8" Lip-to-center strike	7/8" LTC 35.00
Tactile outside lever/knob**	TAC/O 94.00
Tactile inside lever/knob**	TAC/I 94.00
12, 17 Lever Design	12, 17 50.00
Decorative Lever Design	50 to 91 154.50

Vandal Trim Kit Finish

Finish	Price
630	258.00
All others	199.00

** Not available on #17 levers.

40H Strike Packages

Federal Spec. 86

ANSI Series 1000

How To Order

40HST 1 626

Series	Kit number	Finishes	Options
40HST – Strike package	1 – Standard	605 606	Thick Door* – (specify thickness if other than 1-3/4") 7/8** – 7/8" lip-to-center strike SH* – Security head screws RH – Handing (required for 5,6 kit) LH – Handing (required for 5,6 kit)
	4 – Strike Box Only	611 612	
	5 – Latchbolt only	613 618	
	6 – Latchbolt/deadbolt	619 622	
		625 626	
		629 630	
		690	

*Indicates extra cost option.

Part Description	Part Number	Parts Price	Extra Cost Options*	Option Code	Add-On
Strike Packages			Thick door	Specify thickness	35.00
Standard strike package	40HST-1-626	64.00	7/8" Lip-to-center strike	7/8" LTC	35.00
Latchbolt-only strike package	40HST-5-626-RH	69.00	Security head screws	SH	35.00
Latchbolt/deadbolt strike package	40HST-6-626-LH	69.00			
Strike Packages					
Plastic strike box	40HST-4	4.30			
Wrought steel strike box	3126903	12.00			

40H Lever Sets

How To Order

40HLS 14 626

Series	Knob/lever style	Finishes	Options
40HLS – Lever set	Levers:	605 606	Thick door* – (specify thickness if other than 1-3/4") SH* – Security head screws
	3 – Solid tube/return	611 612	
	12* – Solid tube/no return	613 618	
	14 – Curved/return	619 622	
	15 – Contour/angle return	625 626	
	16 – Curved/no return	629 630	
	17* RH – Gull wing right hand	690	
	17* LH – Gull wing left hand	626AM*	
	50-91 – Decorative*	630AM*	
	Knobs:		
	4 – Round		

*Indicates extra cost option.

**Decorative lever design sets are not available.

Part Description	Part Number	Parts Price	Extra Cost Options*	Option Code	Add-On
Lever Sets			Thick door	Specify thickness	35.00
40H Lever Set #3 design	40HLS -3	483.00	Security head screws	SH	35.00
40H Lever Set #12 design	40HLS -12	598.00	UltraShield antimicrobial finish	626AM, 630AM	94.00
40H Lever Set #14 design	40HLS-14	483.00			
40H Lever Set #15 design	40HLS-15	483.00			
40H Lever Set #16 design	40HLS-16	483.00			
40H Lever Set #17 RH design	40HLS -17 RH	598.00			
40H Lever Set #17 LH design	40HLS -17 LH	598.00			
40H Decorative Lever Sets #50-91 designs	40HLS -XX*	838.00			
40H Knob Set #4 design	40HLS-4	483.00			

*Choose one decorative lever set design from #50-91

40H Replacement Spindles

Federal Spec. 86

ANSI Series 1000

How To Order

40HRS	2	
Series	Kit number	Options
40HRS - Replacement spindle kits	2 - 40H Standard spindle 4 - 40H Hook spindle	Thick door* - Specify thickness if other than 1 3/4"

*Indicates extra cost option.

Part Description	Part Number	Parts Price
REPLACEMENT SPINDLES		
40H Swivel spindle assembly	40HRS-2	64.00
40H Hook spindle assembly	40HRS-4	111.00

Extra Cost Options*	Option Code	Add-On
Thick door	Specify Thickness	35.00

40H Screw Kits

How To Order

40HSK	1	626	
Series	Kit number	Finishes	Options
40HSK - Screw kits	1 - H, R, S, J trim screw kit 2 - M, N trim screw kit 3 - Special purpose fasteners screw kit 4 - Surface-mounted trim screw kit 5 - Visual indicator screw kit	606 612 613 622 626	Thick door* - Specify thickness if other than 1-3/4" SH* - Security head screws

*Indicates extra cost option.

Part Description	Part Number	Parts Price
Screw Kits		
H, R, S, J trim screw kit	40HSK-1	43.00
M, N trim screw kit	40HSK-2	43.00
Special purpose fasteners screw kit	40HSK-3	43.00
Surface-mounted trim screw kit	40HSK-4	43.00
Visual indicator screw kit	40HSK-5	43.00

Extra Cost Options*	Option Code	Add-On
Thick door	Specify Thickness	35.00
Security head screws	SH	35.00

*Indicates extra cost option.

40H Faceplate Kits

Federal Spec. 86

ANSI Series 1000

How To Order

40HFP	3	626	
Series	Kit number	Finishes	Options
40HFP - Faceplate kit	0 - for function: AB 1 - for functions: BW, TD, H, HJ 2 - for function: A 3 - for functions: AT, D, C, INL, NX, R, W 4 - for functions: N, LT 5 - for functions: AD, RD, YD, WD 6 - Blank with logo 7 - for functions: BA, S, TA 8 - for functions: B, G, JND, L, LB, T 9 - for functions: CHB, RHB 10 - Blank without logo	605 606 611 612 613 618 619 622 625 626 629 630 690	SH* - Security head screws

*Indicates extra cost option.

Part Description	Parts Price
Faceplate Kits:	
All face plate kits	64.00

Extra Cost Options*	Option Code	Add-On
Security head screws	SH	35.00

*Indicates extra cost option.

40H Visual Indicator Thumb-Turn Kit

Mortise Locks

How To Order

40HVIT	626	1-3/4"
Series	Finishes	Door Thickness
40HVIT	605 612 613 626	1-3/4" Thick door* – Specify thickness if other than 1-3/4"

*Indicates extra cost option.

NOTE: Thick Door option available for doors up to 5" thick

Part Description	Part Number	Parts Price
Visual Indicator Thumb-Turn		
Sectional Visual Thumb-Turn Indicator (H, R & S Trims)	40HVIT	185.00
Escutcheon Visual Thumb-Turn Indicator (J & M Trims)	40HVIT	335.00

Extra Cost Options*	Option Code	Parts Price
Thick door	Specify Thickness	35.00
UltraShield antimicrobial finish	626AM, 630AM	94.00

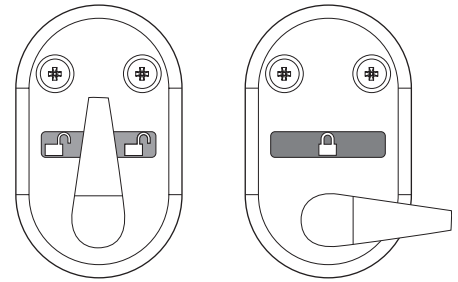

40H Indicator Laminate Kit

Part Description	Part Number	Parts Price
Visual Indicator Laminate		
Visual Indicator Laminate (for Thumb-Turn)	86329	35.00

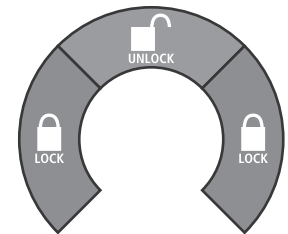

J Series Semi-Trailer Kingpin Locks

Auxiliary Locks

How To Order

Series	Core Housing	Latch Type	Head Type	Armored Front	Options
2J – Standard body	7 – 7-pin housing; accepts all BEST cores	L – Latch (Spring Return) D – Deadlocking Bolt	1 – Single Head Unit 2 – Double Head Unit	1 – Armored Front "–" – No Armored Front	TA* – Extended face without armored front

*TA option not compatible with Armored Front Head type option '1'

Must specify keymark and number of keys or designate L/C for less core.

Function Description	Function Code	Complete With Combined Core			Less Core
		Patented*	Premium**	Standard	
Single latch	L1	1,206.00	1,206.00	1,189.00	1,087.00
Double latch	L2	1,772.00	1,772.00	1,738.00	1,534.00
Single deadbolt	D1	1,163.00	1,163.00	1,146.00	1,044.00
Double deadbolt	D2	1,713.00	1,713.00	1,679.00	1,475.00

*If TA option is not included, only CORMAX M Series patented keying system can be used and pricing shown applies. If TA option is included, BEST Preferred keying system can be used and \$20.00 must be added to pricing shown. **Applicable only if TA option is included.

Part Description	Catalog Number	Price
Storage Racks:		
Three post mount	2J0R3	715.00
Three post—cad. plated	2J0R3C	896.00
Five post mount	2J0R5	1,196.00
Five post—cad. plated	2J0R5C	1,333.00

NOTE: Patented or Premium core is available in J Series with the TA option only.

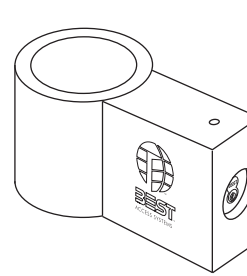

2J7L1

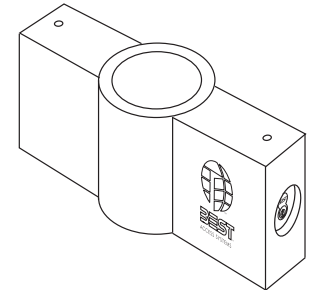

2J7L2

6K Series Grade 2 Cylindrical Locks - Knobs

Cylindrical Locks

Federal Spec. 160

ANSI Series 4000

How To Order

6K	3	7	AB	4	K	STK	630	
Series	Backset	Core Housing	Function Code	Knob Style	Trim Style	Strike Package	Finish	Options
6K	2 – 2-3/8" 3 – 2-3/4" 4* – 3-3/4" 5* – 5"	0 – Keyless 7 – 7-pin housing; accepts all BEST cores	See below	4 – Round	K – 3"	STK – Standard S3 – ANSI LS – Less strike	630 Satin* 606 Bright* 605	L8 – Drive-in latch NF – Narrow face latch (std with 62K) WF – Wide face latch (std with 63K)

*Indicates extra cost option; see below. Must specify keymark and number of keys

Function Description	Function Code	Complete With Combined Core			Less Core
		Patented*	Premium	Standard	
Single Keyed:					
Office	AB	479.00	479.00	462.00	360.00
Storeroom	D	479.00	479.00	462.00	360.00
Classroom	R	479.00	479.00	462.00	360.00
Keyless:					
Passage	N	N/A	N/A	N/A	218.00
Exit	Y	N/A	N/A	N/A	218.00
Privacy	L	N/A	N/A	N/A	291.00
Patio	P	N/A	N/A	N/A	291.00
Single dummy trim	IDT	N/A	N/A	N/A	122.00
Double dummy trim	2DT	N/A	N/A	N/A	232.00

*Patented pricing shown is for CORMAX patented keying system. Add \$20.00 for BEST Preferred patented keying.

Extra Cost Options*	Option Code	Add-On
Satin finishes (per lock)	606	32.00
Bright finishes (per lock)	605	66.00
Special backset	64K / 65K	18.00

Part Description	Part Number	Part Price
2-3/8" deadlocking latch	6KL2	67.00
2-3/4" deadlocking latch	6KL3	67.00
3-3/4" deadlocking latch	6KL4	79.00
5" deadlocking latch	6KL5	79.00
2-3/8" drive-in latch	6KL2-8	67.00
2-3/4" drive-in latch	6KL3-8	67.00
Standard strike package	7KCS2	13.00
ANSI strike package	7KCS3	38.00
Standard strike box	710339380	7.30
Screw pack with tailpiece 630	78073610	3.70
Screw pack with tailpiece 605/606	78073611	3.70
Screw pack without tailpiece 630	78073612	3.10
Screw pack without tailpiece 605/606	78073613	3.10
IDT screw pack	78073614	2.70
2DT screw pack	78073615	3.10
ANSI Strike Box	71547007	6.90

7KC Series Grade 2 Cylindrical Locks - Levers

Cylindrical Locks

Federal Spec. 160

ANSI Series 4000

How To Order

Series	Backset	Core Housing	Function Code	Lever Style	Trim Style	Strike Package	Finish	Options
7KC	3	7	AB	15	D	STK	626	
7KC	2 – 2-3/8" 3 – 2-3/4" 4* – 3-3/4" 5* – 5"	0 – Keyless 6 – 6-pin non-IC cylinder 7 – 7-pin housing; accepts all BEST cores	See below	14 – Curved return 15 – Contour angle return 16 – Curved no return	D – 3-1/2"	STK – Standard S3 – ANSI	626 Satin* 606 612 613 Bright* 605 625	L8 – Drive-in latch (only available on 2-3/8" and 2-3/4" backset) OB** – Zero bitted KA** – Keyed alike KD** – Keyed different OEM*** – Orig equipment mfg ATB – Alternate through-bolt NF – Narrow face latch

*Indicates extra cost option

**Six-pin cylinder in Schlage "C" keyway included with OB, KA, & KD options. Must specify 6 for core housing.

***Cylinders not included with OEM option. Must specify "0" for core housing.

Function Description	Function Code	Complete With Combined Core			Less Core	6-pin non-IC Cylinder OB, KA, KD
		Patented*	Premium	Standard		
Single Keyed:						
Entrance	AB	563.00	563.00	546.00	444.00	524.00
Storeroom	D	563.00	563.00	546.00	444.00	524.00
Classroom	R	563.00	563.00	546.00	444.00	524.00
Keyless:						
Passage	N	N/A	N/A	N/A	325.00	N/A
Exit	Y	N/A	N/A	N/A	315.00	N/A
Privacy	L	N/A	N/A	N/A	356.00	N/A
Single dummy trim	IDT	N/A	N/A	N/A	147.00	N/A

*Patented pricing shown is for CORMAX patented keying system. Add \$20.00 for BEST Preferred patented keying.

Extra Cost Options*	Option Code	Add-On
Satin finishes (per lock)	612, 613, etc.	32.00
Bright finishes (per lock)	605, 625, etc.	66.00
Special backset	74KC / 75KC	18.00

Part Description	Part Number	Part Price
2-3/8" deadlocking latch	7KCL2	67.00
2-3/4" deadlocking latch	7KCL3	67.00
3-3/4" deadlocking latch	6KL4	79.00
5" deadlocking latch	6KL5	79.00
Standard strike package	7KCS2	13.00
ANSI strike package	7KCS3	38.00
Throw member	B56165	4.10
Standard strike box	B25640	7.30

8K Series Grade 1 Cylindrical Locks - Knobs

Cylindrical Locks

Federal Spec. 160

ANSI Series 4000

How To Order

8K	3	7	AB	4	D	STK	626	
Series	Backset	Core Housing	Function Code	Knob Style	Rose Style	Strike Package	Finish	Options
8K	3 – 2-3/4"	0 – Keyless	See below	4 – Round	A – 3-3/8" concave	STK – Standard	626 690	3/4* – 3/4" throw
	4* – 3-3/4"	7 – 7-pin housing; accepts all BEST cores		6 – Tulip	C – 2-9/16" concave	S3 – ANSI	626AM*	BRK – Break-away (keyed only)
	5* – 5"				D – 3-3/8" convex	S3 7/8* – 7/8" lip-to-center strike	Satin* 606 612 613 619	FRL* – Full radius latch
					E – 3-3/8" concave – thick door	LS – Less strike S5 S6	Bright* 605 611 625	LL* – Lead lined (not available in double keyed functions)

*Indicates extra cost option; see below. Must specify keymark and number of keys.

Function Description	Function Code	Complete With Combined Core			Less Core
		Patented*	Premium	Standard	
Single Keyed:					
Entrance	AB	1,123.00	1,123.00	1,106.00	1,004.00
Storeroom	D	1,123.00	1,123.00	1,106.00	1,004.00
Service station	E	1,123.00	1,123.00	1,106.00	1,004.00
Classroom	R	1,123.00	1,123.00	1,106.00	1,004.00
Dormitory	T	1,123.00	1,123.00	1,106.00	1,004.00
Special	Note**	1,123.00	1,123.00	1,106.00	1,004.00
Hotel (SPN-standard)	H, HJ	1,216.00	1,216.00	1,199.00	1,097.00
Double Keyed:					
Corridor	C	1,173.00	1,173.00	1,139.00	935.00
Storeroom	G	1,173.00	1,173.00	1,139.00	935.00
Communicating	S	1,173.00	1,173.00	1,139.00	935.00
Institutional	W	1,173.00	1,173.00	1,139.00	935.00
Special	DR, RD	1,173.00	1,173.00	1,139.00	935.00
Keyless:					
Passage	N, NX	N/A	N/A	N/A	757.00
Exit	Y	N/A	N/A	N/A	757.00
Privacy	L	N/A	N/A	N/A	871.00
Patio	P	N/A	N/A	N/A	871.00
Special	LL, M, Q, Z	N/A	N/A	N/A	871.00
Single dummy trim	1DT	N/A	N/A	N/A	328.00
Double dummy trim	2DT	N/A	N/A	N/A	656.00

*Patented pricing shown is for CORMAX patented keying system. Add \$20.00 for BEST Preferred patented keying.

**Single-keyed special functions include: A, B, DZ, EA, RH, RZ, XD, XR, YD, YR, YRH, YRM and YZ

ATTENTION: Locksets that secure both sides of the door (e.g., G, DR, M, RD, S, W, XD, YD & YR functions) are controlled by building codes and the Life Safety Code. Delay in unlocking for rapid emergency exit could be hazardous or even fatal.

8K Series Grade 1 Cylindrical Locks (continued)

Extra Cost Options*	Option Code	Add-On
Satin finishes (per lock)	606, 612, 613, etc.	32.00
Bright finishes (per lock)	605, 611, 625, etc.	66.00
UltraShield antimicrobial finish	626AM	90.00
3/4" throw latch	3/4	50.00
Special backsets	84K / 85K	34.00
Lead lined	LL	334.00
Security head screws	SH	35.00
Tactile knob both sides	TAC/B	126.00
Tactile knob outside	TAC/O	66.00
Tactile knob inside	TAC/I	66.00
7/8" Lip-to-center strike	S3 7/8	35.00
Full radius latch	FRL	34.00

Parts Description	Part Number	Part Price
2-3/4" deadlocking latch	8KL3	119.00
3-3/4" deadlocking latch	8KL4	148.00
5" deadlocking latch	8KL5	148.00
Standard strike package	8KS2	13.00
ANSI strike package	8KS3	38.00
Throw member 7-pin	B92506	4.10
Breakaway knob driver	B54856	14.00

NOTE 1: Other special single keyed functions include: A,B, EA, DZ, RZ, XD, XR, YD & YR.
 ATTENTION: Locksets that secure both sides of the door (e.g. G, DR, M, RD, S, W, XD, YD & YR functions) are controlled by building codes and the Life Safety Code. Delay in unlocking for rapid emergency exit could be hazardous or even fatal.

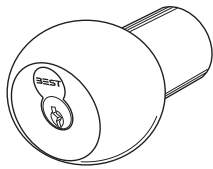

4 – Round

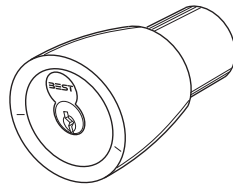

6 – Tulip

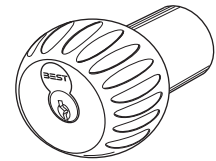

4 – TAC option
 (Blind, safety, & handicapped application)

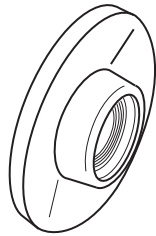

A and C Rose
 (Concave)



D Rose
 (Convex)

9K Series Grade 1 Cylindrical Locks - Levers

Cylindrical Locks

Federal Spec. 160

ANSI Series 4000

How To Order

9K	3	7	AB	14	C	STK	626	
Series	Backset	Core Housing	Function Code	Lever Style	Rose Style	Strike Package	Finish	Options
9K	3 – 2-3/4" 4* – 3-3/4" 5* – 5" DT – Dummy Trim	0 – Keyless functions / or / Non-IC and LFIC competitive cylinder (less core) [†] 6 – 6-pin non-IC cylinder 7 – 7-pin housing; accepts all BEST cores	See below (Contact sales support for special functions and pricing.)	14 – Curved with return 15 – Contour angle with return 16 – Curved without return	C – 3" convex D – 3-1/2" convex K – 3" convex no ring L – 3-1/2" convex no ring	STK – Standard S3 – ANSI S3 7/8** STK 7/8*** LS – Less strike S3B* – ANSI (Strike w/ Plastic Box) S3B 7/8* – ANSI (Strike w/ Plastic Box)	626 690 622 626AM* Satin* 606 612 613 619 Bright* 605 611 625 618	3/4* – 3/4" throw latch AL/B* – Abrasive lever both sides AL/O* – Abrasive lever outside AL/I* – Abrasive lever inside TL/B* – Tactile lever both sides TL/O* – Tactile lever outside TL/I* – Tactile lever inside ATB – 2-3/4" Through bolt Prep ATB2 – 2-5/8" Through bolt prep FRL* – Full radius latch LL* – Lead lined (N/A for double keyed functions) LM – Lost motion SH* – Security head screws Thin Door* – 1-3/8" OB* – non-IC zero bitting KA* – non-IC keyed alike KD* – non-IC keyed different COR* – non-IC Corbin-Russwin MED* – non-IC Medeco ROE* – Request to Exit SAR* – non-IC Sargent SCH* – non-IC Schlage YAL* – non-IC Yale SARRC – LFIC Sargent CORRC – LFIC Corbin YALRC – LFIC Yale SCHRC – LFIC Schlage WS – Windstorm Label (Florida Building Code)

[†]Indicates extra cost. Must specify keymark and number of keys.
^{**}S3 7/8 is the ANSI flat lip strike
^{***}STK 7/8 is the standard flat lip strike

COR, MED, SAR, SCH: Choose only one option. OB, KA, KD; use with core housing option 6
 SCHRC, CORRC, SARRC, YALRC: Use with core housing option 0

Function Description	Function Code	Complete With Combined Core			Less Core	6-pin non-IC Cylinder OB, KA, KD
		Patented*	Premium	Standard		
Single Keyed:						
Entrance	AB	1,066.00	1,066.00	1,049.00	947.00	1,027.00
Storeroom	D	1,066.00	1,066.00	1,049.00	947.00	1,027.00
Service station	E	1,066.00	1,066.00	1,049.00	947.00	1,027.00
Classroom	R	1,066.00	1,066.00	1,049.00	947.00	1,027.00
Dormitory	T	1,066.00	1,066.00	1,049.00	947.00	1,027.00
Special**	Note	1,066.00	1,066.00	1,049.00	947.00	1,027.00
UA	UA	1,066.00	1,066.00	1,049.00	947.00	1,027.00
Hotel	H, HJ	1,158.00	1,158.00	1,141.00	1,039.00	1,119.00
Double Keyed:						
Corridor	C	1,274.00	1,274.00	1,240.00	1,036.00	1,196.00
Storeroom	G	1,274.00	1,274.00	1,240.00	1,036.00	1,196.00
Intruder***	IN	1,319.00	1,319.00	1,285.00	1,081.00	1,241.00
Communicating	S	1,319.00	1,319.00	1,285.00	1,081.00	1,241.00
Institutional	W	1,319.00	1,319.00	1,285.00	1,081.00	1,241.00
Special	DR, RD	1,319.00	1,319.00	1,285.00	1,081.00	1,241.00
Keyless:						
Passage	N, NX	N/A	N/A	N/A	663.00	N/A
Exit	Y	N/A	N/A	N/A	663.00	N/A
Privacy	L	N/A	N/A	N/A	762.00	N/A
Patio	P	N/A	N/A	N/A	762.00	N/A
Special	LL, M, Q, Z	N/A	N/A	N/A	762.00	N/A
Single dummy trim	1DT	N/A	N/A	N/A	283.00	N/A
Double dummy trim	2DT	N/A	N/A	N/A	552.00	N/A

*Patented pricing shown is for CORMAX patented keying system. Add \$20.00 for BEST Preferred patented keying.

**Single-keyed special functions include: A, B, DZ, EA, RH, RZ, XD, XR, YD, YR, YRH, YRM and YZ
 ***IN Function includes interior indicator rose standard

9K Series Grade 1 Cylindrical Locks (continued)

Cylindrical Locks

Extra Cost Options*	Option Code	Add-On
Satin finishes (per lock)	606, 612, 613, etc.	32.00
Bright finishes (per lock)	605, 625, 629, etc.	66.00
UltraShield antimicrobial finish	626AM	90.00
Thin door 1-3/8"	1-3/8"	120.00
3/4" throw latch	3/4	50.00
Special backsets	94K / 95K	34.00
Request to Exit	ROE	247.00
Lead lined	LL	334.00
Security head screws	SH	35.00
Abrasive lever both sides	AL/B	66.00
Abrasive lever outside	AL/O	35.00
Abrasive lever inside	AL/I	35.00
Tactile lever both sides	TL/B	126.00
Tactile lever outside	TL/O	66.00
Tactile lever inside	TL/I	66.00
7/8" Lip-to-center strike	S3 7/8 or STK 7/8	35.00
Strike with plastic box	S3B or S3B 7/8	35.00
Full radius latch	FRL	34.00

*Choose only one option: OB, KA, KD-use with core housing option 6. COR, MED, SAR, SCH, YAL, SCHRC-use with core housing option 0

Extra Cost Options*	Option Code	Add-On
Non-IC Corbin-Russwin (single keyed)	COR	10.00
Non-IC Corbin-Russwin (double keyed)	COR	26.00
Non-IC Medeco (single keyed)	MED	10.00
Non-IC Medeco (double keyed)	MED	26.00
Non-IC Sargent (single keyed)	SAR	10.00
Non-IC Sargent (double keyed)	SAR	26.00
Non-IC Schlage (single keyed)	SCH	10.00
Non-IC Schlage (double keyed)	SCH	26.00
Non-IC Yale (single keyed)	YAL	10.00
Non-IC Yale (double keyed)	YAL	26.00

NOTE: These options do not come with a cylinder. The lock is just prepped for cylinders of these other manufacturers and comes with a throw member for that manufacturer's cylinder.

Part Description	Part Number	Part Price
2-3/4" deadlocking latch	8KL3	119.00
3-3/4" deadlocking latch	8KL4	148.00
5" deadlocking latch	8KL5	148.00
Standard strike package	8KS2	13.00
ANSI strike package	8KS3	38.00
Throw member 7-pin	B92505	4.10

NOTE † Other special single keyed functions include: AB, EA, DZ, RZ, XD, XR, YD & YR.

ATTENTION: Locksets that secure both sides of the door (e.g. G, DR, M, RD, S, W, XD, YD & YR functions) are controlled by building codes and the Life Safety Code. Delay in unlocking for rapid emergency exit could be hazardous or even fatal.

Adapttion Kit

9KA	SCHRCKT		Price
Family	Kit Type	Lever Style	Finish
9KA – Adaptation Kit	SCHRCKT – Schlage RC Adaptation Kit	14 – Curved return 15 – Contour angle return 16 – Curved no return	606, 626, 612, 613 138.00

NOTE: Lever Style 16 is considered a special order item and may have extended lead times. Consult factory for lead times.

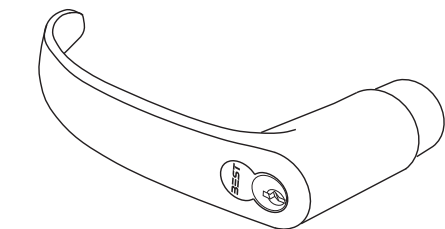

14 – Curved return

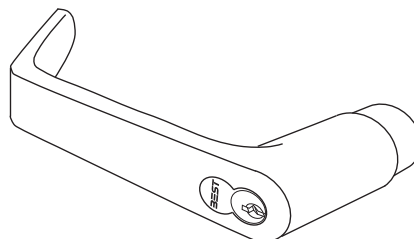

15 – Contour angle return

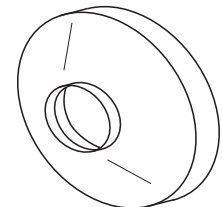

C and D Roses

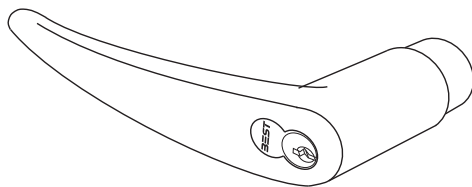

16 – Curved no return

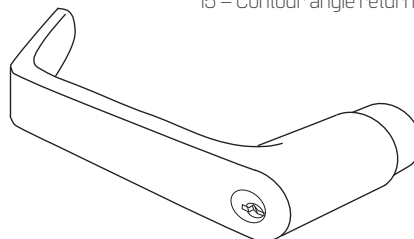

15 – Non IC contour angle return

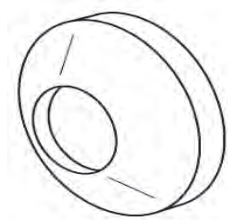

K and L Roses

AK Series Knob Adaptations (formerly KA series)

Cylindrical Locks

How To Order

Series	Adaptation Kit Number	Finish
AK	Please contact BEST for the specific kit number to convert your heavy duty lockset. The name of the manufacturer and model number are required.	626

Must specify keymark and number of keys.

Manufacturer's Name	Complete With Combined Core			Less Core Price
	Patented*	Patented*	Premium	
Corbin	361.00	361.00	344.00	242.00
Sargent	397.00	397.00	380.00	278.00
Schlage	326.00	326.00	309.00	207.00
Russwin	361.00	361.00	344.00	242.00
Yale	397.00	397.00	380.00	278.00

Installation at BEST Factory 104.00

Kit Components	Knob Only Less Core	Throw Member
Corbin	207.00	55.00
Sargent	237.00	40.00
Schlage	175.00	36.00
Russwin	203.00	55.00
Yale	237.00	45.00

*Patented pricing shown is for CORMAX patented keying system. Add \$20.00 for BEST Preferred patented keying.

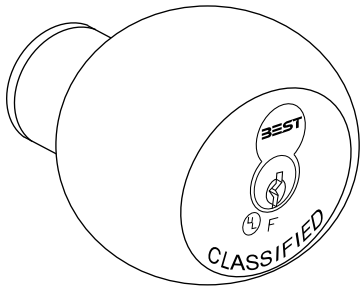

Schlage round

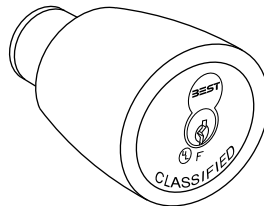

Schlage tulip

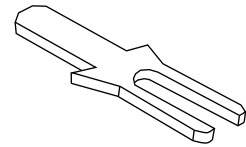

Schlage throw member

L Series Cabinet Locks

Cabinet, Push and Siding

How To Order

5L	7	R	D	2	606	
Series	Core Housing	Mounting Type	Latch Type	Hand	Finish	Options
3L – Coin box	5 – 5-pin housing 6 – 6-pin housing 7 – 7-pin housing; accepts all BEST cores	R – Rim	D – Dead-locking	2 – Vertical	626 690 Satin* 606 612 613 619	1-1/8" to 2"* – Special cylinder (specify length)
5L – Standard		M – Mortise R – Rim	D – Dead-locking L – Latchbolt	2 – Vertical 5 – Inverted	Bright* 605 611 625	T – Deadlocking SL* – Square Latch, spring loaded TR – Special trim ring A450 – Special strike A451 – Special strike A452 – Special strike A453 – Special strike

*Indicates extra cost option; see below. Must specify keymark and number of keys.

Description	Series	Complete With Combined Core			Less Core
		Patented*	Premium	Standard	
Cabinet Locks					
Cabinet–mortise & rim	3L	266.00	266.00	249.00	147.00
Cabinet–mortise & rim	5L	229.00	229.00	212.00	110.00

Extra Cost Options*	Option Code	Add-On
Square latch spl. cylinder	SL	32.00
Special cylinders-3L	1-1/2" to 2"	34.00
Special cylinders-5L	1-1/8" to 2"	34.00
Special finishes	See above	8.30

Description	Series	Complete With Combined Core			Less Core
		Patented*	Premium	Standard	
8I Series Mail Box Lock					
Standard mail box lock	8L7SPR-627	302.00	302.00	285.00	183.00

*Patented pricing shown is for CORMAX patented keying system. Add \$20.00 for BEST Preferred patented keying.

NOTE: You must specify the name of the manufacturer and the model number.

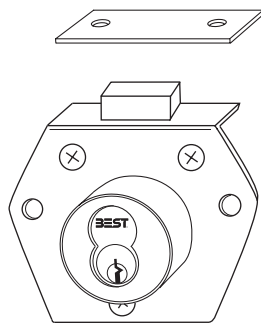

5L7RD2

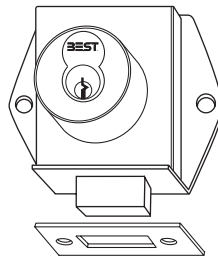

5L7MD

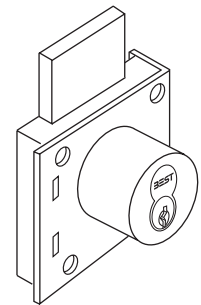

3L7RD2 - Vertical Only

P Series Push Locks

Cabinet, Push and Siding

How To Order

2P	7	3	626
Series	Lock Body	Mounting slot	Finish
2P – File cabinet	7 – 7-pin body may be keyed 6-pin	3 – Vertical 4 – Horizontal	606 626

Description	Catalog No.	Complete With Combined Core			Less Core
		Patented*	Premium	Standard	
2P Series					
Vertical mounting slot	2P73	300.00	300.00	283.00	181.00
Horizontal mounting slot	2P74	300.00	300.00	283.00	181.00

*Patented pricing shown is for CORMAX patented keying system. Add \$20.00 for BEST Preferred patented keying.

NOTE: You must specify the name of the manufacturer and the model number.

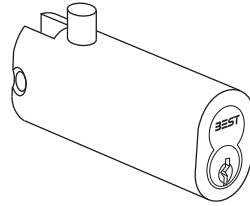

2P73

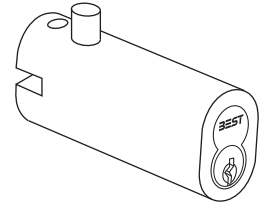

2P74

S Series Sliding Door Locks

Cabinet, Push and Sliding

How To Order

3S	7	5	627	
Series	Core housing	Function code	Finish	Options
2S – Sliding door push 3S – Sliding panel 4S – Sliding door cyl.	7 – 7-pin housing; accepts all BEST cores (4S requires 6C core)	See below	2S – 626, 605, 606, 622, 625 4S – 625, 605, 606, 626 3S – 627	3S – Strike straps: S1* – 1/4" thick S2* – Standard 1/4" S3 – 5/16" to 1/2" S4 – 1/2" to 11/16" S5 – 3/4" & thicker

*Included in the price of the housing.

Function Description	Catalog Number	Complete With Combined Core			Less Core
		Patented*	Premium	Standard	
2S Series					
Surface mount–1/2" bolt	3	391.00	391.00	374.00	272.00
Through bolt–1/2" bolt	3TBM	472.00	472.00	455.00	353.00
Through bolt–3/4" bolt	4TBM	472.00	472.00	455.00	353.00
Surface mount–bolt pin	5	472.00	472.00	455.00	353.00
3S Series					
Straight housing	5	333.00	333.00	316.00	214.00
Captured panel housing	7	333.00	333.00	316.00	214.00
Housing with 1" extension	8	434.00	434.00	417.00	315.00
4S Series					
Sliding glass door cylinder	3	235.00	235.00	218.00	116.00
Sliding wood door cylinder	4	256.00	256.00	239.00	137.00

* Patented pricing shown is for CORMAX patented keying system. Add\$20.00 for BEST Preferred patented keying.

** Lock requires 6C core (not available with Peaks or Preferred keying).

Function Description	Par Number	Separate	With Lock Add-On
3S Strike Straps			
4-1/4" long for 1/4" panel	3SS1	39.00	N/A
6-1/4" long for 1/4" panel	3SS2	45.00	N/A
Standard			
6-1/4" long for 5/16" to 1/2"	3SS3	64.00	26.00
6-1/4" long for 1/2" to 11/16"	3SS4	76.00	40.00
6-1/4" long for 3/4" or thicker	3SS5	59.00	11.00

SPSL – Secure Patient Safety Lever

Specialty Hardware

How To Order – Mortise Safety Levers

SPSL	ML	R	16F	630	RH
Series	Chassis	Function	Lever	Finish	Hand
SPSL – Secure Patient Safety Lever	ML – Mortise	A – Office privacy	16F – Anti-ligature lever	630 – Satin stainless steel	RH LH RHR LHR
		D – Storeroom			
		IND – Intruder deadbolt			
		IND2 – Intruder storeroom dblt			
		INL – Intruder latch			
		LT – Bathroom privacy			
		LTF – Bedroom privacy (Anti-Lockout)			
		R – Classroom			
		RF – Bedroom privacy			
		T – Dormitory deadbolt			
		W1 – Asylum lever/lever			
		W2 – Asylum double cyl lever/lever			
		W3 – Asylum deadbolt lever/lever			
W4 – Asylum deadbolt double cyl lever/lever					
W10 – Asylum lever/blank					
W20 – Asylum double cyl lever/blank					
W30 – Asylum deadbolt lever/blank					
W40 – Asylum deadbolt double cyl lever/blank					

Product Description	Function Code	Price*
Mortise Safety Lever		
Office privacy	A	2,557.00
Storeroom	D	2,357.00
Intruder deadbolt	IND	2,357.00
Intruder storeroom deadbolt	IND2	2,357.00
Intruder latch	INL	2,357.00
Bathroom privacy	LT	2,557.00
Passage	ON	2,156.00
Bedroom privacy (RF)	RF	2,557.00
Bedroom privacy Anti-Lockout (LTF)	LTF	2,557.00
Classroom	R	2,357.00
Dormitory deadbolt	T	2,357.00
Asylum lever/lever	W1	2,357.00
Asylum double cyl lever/lever	W2	2,357.00
Asylum deadbolt lever/lever	W3	2,357.00
Asylum deadbolt double cyl lever/lever	W4	2,357.00
Asylum lever/blank	W10	2,357.00
Asylum double cyl lever/blank	W20	2,357.00
Asylum deadbolt lever/blank	W30	2,357.00
Asylum deadbolt double cyl lever/blank	W40	2,357.00

How To Order – Cylindrical Safety Levers

SPSL	CL	ON	16F	630	RH
Series	Chassis	Function	Lever	Finish	Hand
SPSL – Secure Patient Safety Lever	CL – Cylindrical 2-3/4" backset	ON – Cylindrical passage	16F – Anti-ligature lever	630 – Satin stainless steel	RH LH RHR LHR
	CL5 – Cylindrical 5" backset	ONX – Cylindrical passage blank interior			

Product Description	Function Code	Price
Cylindrical Safety Lever		
Passage	ON	1,875.00
Passage blank interior	ONX	1,875.00
Dummy Trim		
Dummy Trim	DT	1,044.00

SPSL – Secure Patient Safety Lever (continued)

Part Description	Kit Number	List Price
Cylindrical Security head screw kit	SPSL-SH C1	33.00
Mortise Security head screw kit	SPSL-SH M1	33.00
Security head driver kit	SPSL-SH D1	33.00
Turnpiece Disable kit for Female Privacy Locks	SPSL-TD	180.00
Cylinder Protector for IC core cylind. SPSL (incl. 2 keys)	SPSL-CP-IC	1,240.00
Cylinder Protector for non-IC cylind. SPSL (incl. 2 keys)	SPSL-CP-NIC	1,240.00
Extra magnetic key for SPSL-CP	SPSL-CP-K	53.00

How To Order – Electrified Mortise Safety Levers

SP	SE	ML	R	N	L	630	RH			
Series	Electric Release Trim[s]			Chassis	Interior Trim Blank	Function Group			Finish	Hand
	Designation	Exterior	Interior			RQE	DPS	LPS		
SP – Secure Patient Safety	SE	Electric Release Trim (Fail Secure)	Mechanical	ML – Mortise	'leave empty' – if interior trim required (standard) X** – No trim on the interior, just a blank plate (SPSE or SPSF only)	R* – Request to Exit N – Place-holder if RQE not selected	D* – Door Position N – Place-holder if DPS not selected	L* – Latch Position N – Place -holder if LPS not selected	630 – Satin Stainless Steel	RH LH RHR LHR
	SF	Electric Release Trim (Fail Safe)	Mechanical							
	S3	Electric Release Trim (Fail Secure)	Electric Release Trim (Fail Secure)							
	S4	Electric Release Trim (Fail Safe)	Electric Release Trim (Fail Safe)							

*Indicates extra cost option.
**Option only available for SPSE and SPSF trims. Security hardware comes standard.

Function Description	Function Code	Price*
SPSE - Exterior Release Trim (Fail Secure)	NNN†	3,713.00
SPSF - Exterior Release Trim (Fail Safe)	NNN†	3,878.00
SPS3 - Exterior/Interior Release Trim (Fail Secure)	NNN†	3,808.00
SPS4 - Exterior/Interior Release Trim (Fail Safe)	NNN†	3,878.00

Extra Cost Options*	Option Code	Add-On
Function Code (RQE)	R	84.00
Function Code (DPS)	D	125.00
Function Code (LPS)	L	84.00

†Indicates extra cost options for RQE, DPS or LPS functions.
*Standard offering is less cylinder and less core.
*Patented pricing shown is for CORMAX patented keying system.
Add \$20.00 for Best Preferred patented keying. †Indicates extra cost options for RQE, DPS or LPS functions.

SSRL - Secure Seclusion Room/Time Out Room Locks

Specialty Hardware

Product Description	Product Number	Price
3-Point constant supervision	SSRLS-3	2,995.00
3-Point unsupervised	SSRLU-3	3,202.00
Alum. angled strike kit for 3 point outswing doors	SSRL-SK3	748.00
Single point constant supervision	SSRLS-1	1,771.00
Single point constant supervision, includes strike kit for outswing doors	SSRLS-1-SK1	1,848.00
Single point unsupervised	SSRLU-1	1,975.00
Single point unsupervised, includes strike kit for outswing doors	SSRLU-1-SK1	2,052.00
Strike kit for single point outswing doors	SSRL-SK1	84.00
3-Point constant supervision w/ digital counter	SSRLS-3-C	3,285.00
3-Point unsupervised w/ digital counter	SSRLU-3-C	3,488.00

SPECIAL NOTE: Normal discount structure does NOT apply to list prices on this page. Obtain net price quotes from your local BEST Sales Representative.

SEDA – Secure Emergency Door Alarm

Specialty Hardware

Product Description	Product Number	Price
Sensor - 36" to 42" wide door	SEDA-DSA-P1	1,314.00
Sensor - 42" to 48" wide door	SEDA-DSA-P2	1,414.00
12 Door controller/power supply	SEDA-CPS-1A52-12	4,076.00
24 Door controller/power supply	SEDA-CPS-1A52-24	7,157.00
36 Door controller/power supply	SEDA-CPS-1A52-36	10,236.00
48 Door controller/power supply	SEDA-CPS-1A52-48	14,349.00
Second console output	SEDA-CPS-MOD-CONS-2	479.00
12 Door LED console	SEDA-DCRS-12	2,596.00
24 Door LED console	SEDA-DCRS-24	4,321.00
36 Door LED console	SEDA-DCRS-36	6,047.00
48 Door LED console	SEDA-DCRS-48	11,079.00
12 Door LED Wall Console	SEDA-WCRS-12	3,704.00
24 Door LED Wall Console	SEDA-WCRS-24	5,674.00
36 Door LED Wall Console	SEDA-WCRS-36	7,945.00
Wall mounted keyswitch	SEDA-KSI01	479.00
Strobe light ceiling mount	SEDA-SL1	229.00
Strobe light ceiling mount w/ steel mounting plate	SEDA-SL2	278.00
Full surface angled alum. hinge modified for new or existing hinges	SEDA-ECHFS-MH-AL-4	1,539.00
Splice box for room w/ multiple doors	SEDA-SPLB-1	278.00

SPECIAL NOTE: Normal discount structure does NOT apply to list prices on this page. Obtain net price quotes from your local BEST Sales Representative.

T Series Tubular Deadbolts

Tubular Locks

Federal Spec. 180, 181

NOTE: 8T=ANSI/BHMA Grade 1 • 6T=ANSI/BHMA Grade 2

How To Order

8T/6T	3	7	K	STK	606	
Series	Backset	Core Housing	Function Code	Strike	Finish	Options
8T	2 – 2-3/8"	0 – Keyless	See below	STK – Std deadbolt	8T	CS* – Concealed screws
6T	3 – 2-3/4"	7 – 7-pin housing; accepts all BEST cores		S1 – ANSI deadbolt	626 690	D5 – Drive-in bolt (8T only)
				S4 – Lip deadbolt	626AM*	LL* – Lead lined (8T only)
				S5* – High security deadbolt (only available in 630 finish)	Satin*	NF – Narrow face 1" on 8T3 (std. on 8T2)
					606 612	WF – Wide face 1-1/8" on 8T2 (std. on 8T3)
					613 619	SH* – Security head screws (8T only)
					Bright*	Thick Door* – specify thickness (8T only)
					605 611	Thin Door* – specify thickness (8T only)
					625	
					6T	
					626	

*Indicates extra cost option; see below.

**6T adjustable backset. Backset selection not required.

Description	Function Code	Complete With Combined Core			Less Core
		Patented*	Premium	Standard	
8T Deadbolts					
Single-keyed—turnknob	K	430.00	430.00	413.00	311.00
Single-keyed—no turnknob	L	430.00	430.00	413.00	311.00
Non-keyed—turnknob	KL	N/A	N/A	N/A	258.00
Double-keyed—CS-standard	M	645.00	645.00	611.00	407.00
Single-keyed—classroom	S	430.00	430.00	413.00	311.00
6T Deadbolts					
Single-keyed—turnknob	K	316.00	316.00	299.00	197.00
Single-keyed—no turnknob	L	316.00	316.00	299.00	197.00
Double-keyed	M	393.00	393.00	376.00	274.00
Non-keyed turnknob	KL	N/A	N/A	N/A	164.00

* Patented pricing shown is for CORMAX patented keying system. Add \$20.00 for Best Preferred patented keying.

Extra Cost Options*	Option Code	Add-On
Satin finishes (per lock) (8T only)	606, 612, 613, etc.	40.00
Bright finishes (per lock) (8T only)	605, 611, 625, etc.	40.00
UltraShield antimicrobial finish (8T only)	626AM	60.00
Concealed screws (8T only)	CS	68.00
Lead lined (8T only)	LL	240.00
High security strikes (8T only)	S5	55.00
Security head screws (8T only)	SH	35.00
Thick door (8T only)	Specify thickness	59.00
Thin door (8T, M function only)	Specify thickness	59.00

ATTENTION: Locksets that secure both sides of the door (e.g. L and M functions) and their use is controlled by building codes and the Life Safety Code. Delay in unlocking for emergency exit could be hazardous or even fatal.

Part Description	Part Number	Part Price
2-3/8" Deadbolt tube	8TD2B	74.00
2-3/4" Deadbolt tube	8TD3B	74.00
2-3/8" Drive-in bolt	8TD25	74.00
2-3/4" Drive-in bolt	8TD35	74.00
Std. deadbolt strike pkg.	8TSSTK	14.00
ANSI deadbolt strike pkg.	8TSI	43.00
Deadbolt lip strike pkg.	8TS4	14.00
High security strike pkg. / deadbolt	8TS5*	75.00

* 8TS5 only available in 630 finish

W Series Electric Switch Locks

Electromechanical Locks

How To Order

Series	Core Housing	Function code	Finish	Optional Box**
1W	7 – 7-pin housing; accepts all BEST cores	See below	626 690 Satin* 606 612 613 619 Bright* 605 611 625	See below

*Indicates extra cost option; see below.

**Not all boxes are compatible with all switch locks. See the catalog for details.

Function Description	Switch Type	Key Position 2***	Key Position 3***	Function Code	Complete With Combined Core			Less Core
					Patented*	Premium	Standard	
Maintained Switch Locks								
Low voltage	SPDT	3 o'clock	N/A	A1	391.00	391.00	374.00	272.00
Single switch	SPDT	2 o'clock	N/A	B1	350.00	350.00	333.00	231.00
Single switch	SPDT	12 o'clock	N/A	B2	350.00	350.00	333.00	231.00
Single switch	SPST	5 o'clock	12 o'clock	C2**	467.00	467.00	450.00	348.00
Toggle switch	DPST	2 o'clock	N/A	D2	430.00	430.00	413.00	311.00
Toggle switch	TPDT	3 o'clock	9 o'clock	E2	436.00	436.00	419.00	317.00
Toggle switch	SPDT	2 o'clock	12 o'clock	L2	475.00	475.00	458.00	356.00
Dual switch	2 SPDT	3 o'clock	N/A	J1	458.00	458.00	441.00	339.00
Dual switch	2 SPDT	12 o'clock	N/A	J2	513.00	513.00	496.00	394.00
Momentary Switch Locks								
Single switch	SPDT	2 o'clock	12 o'clock	B3	391.00	391.00	374.00	272.00
Dual switch	2 SPDT	2 o'clock	12 o'clock	J3	458.00	458.00	441.00	339.00
Toggle switch	DPDT	2 o'clock	10 o'clock	K4	458.00	458.00	441.00	339.00
Dual switch	2 SPDT	2 o'clock	10 o'clock	P4	430.00	430.00	413.00	311.00
Quad switch	4 SPDT	2 o'clock	10 o'clock	R4	451.00	451.00	434.00	332.00

*Patented pricing shown is for CORMAX patented keying system. Add \$20.00 for BEST Preferred patented keying.

**Supplied with OC1 box only (included in price).

***Key position 1 for all switch locks is 12 o'clock except for the C2 function which is at 7 o'clock and the L2 function which is at 10 o'clock position.
For all switch locks, the key is removable in the 12 o'clock position only.

Extra Cost Options*/Optional Boxes

Description	Code	Price
Satin finishes	606, 612, 613 etc.	7.20
Bright finishes	605, 611, 625 etc.	9.60
Interior box	INT	84.00
Standard octagon center mount	OC1	83.00
Deep octagon offset mount	OC2	137.00
Standard weather resistant box	SWR	428.00

Parts

Function Code	Replacement Switch #	Price
A1	S4A	72.00
B1, B2, B3, J1, J2, J3, P4, & R4	S4B	29.00
C2	S4C	126.00
D2	S4D	49.00
E2	S4E	110.00
K4	S4K	110.00
L2	S4L	96.00

45HW Series Electromechanical Mortise Locks

Electromechanical Locks

How To Order

Series	Core Housing	Function Code	Lever Style	Trim Style	Finish	Door Hand	Options
45HW	0** – Less Core Housing 7 – 7-pin housing, accepts all BEST cores	Electrically-locked*** DEL LEL NXEL TDEL TWEL WEL Electrically-unlocked**** DEU LEU NXEU TDEU TWEU WEU	Levers: 3 – Solid tube/return 12* – Solid tube/no return 14 – Curved/return 15 – Contour/angle return 16 – Curved/no return 17* – Gull wing Knobs: 4 – Round Decorative**** 50-91	H – 2-3/4" dia. R – 2-3/4" dia. S – 3-1/2" dia. J * – Wrought M * – Forged N * – Forged (concealed cylinder; N trim invalid on non-keyed and double keyed functions)	626 630 690 622 626AM* 630AM* Satin* 606 612 613 619 Bright* 605 611 625 629	RH RHR LH LHR	C * – Pre-Terminated Quick Connect Plug DS * – Door status monitor IDH * – Integrated Door Hardware LL * – Lead lined LS * – Latch status monitor RQE * – Request to exit Thick door* – Specify thickness 7/8 *** – Flat lip strike VT * – Vandal Trim 12V – 12V Solenoid (24V is standard) TAC/I * – Tactile Lever Inside TAC/O * – Tactile lever Outside TAC/B * – Tactile Lever Both VIN * – Visual Indicator SH * – Security Head Screws

* Indicates extra cost, see below.

** Indicates cost deduction; see below.

*** Fail safe functions (EL) and fail secure functions (EU) include a Temperature Control Module (TCM) with the price of the lock.

**** Decorative levers are considered special order items that may have extended lead times. Consult factory for lead times. Available decorative levers: 50-53, 55, 60, 62-63, 65, 69, 75, 79-81, and 89.

† See BEST Hinges & Door Accessories price book for Wire Harness product

^ IDH option - gives both RQE and DS options in one

Function Description	Function Code	Patented*	Premium	Standard	Less Core
45HW Electromechanical:					
45HW Single key, latch, fail secure	DEU	2,259.00	2,259.00	2,242.00	2,140.00
45HW Single key, latch, fail safe	DEL	2,259.00	2,259.00	2,242.00	2,140.00
45HW Double key, latch, fail secure	WEU	2,459.00	2,459.00	2,425.00	2,221.00
45HW Double key, latch, fail safe	WEL	2,459.00	2,459.00	2,425.00	2,221.00
45HW Keyless, latch, fail secure	NXEU	N/A	N/A	N/A	2,059.00
45HW Keyless, latch, fail safe	NXEL	N/A	N/A	N/A	2,059.00
45HW Single key, deadbolt, fail secure	TDEU	2,301.00	2,301.00	2,284.00	2,182.00
45HW Single key, deadbolt, fail safe	TDEL	2,301.00	2,301.00	2,284.00	2,182.00
45HW Double key, deadbolt, fail secure	TWEU	2,501.00	2,501.00	2,467.00	2,263.00
45HW Double key, deadbolt, fail safe	TWEL	2,501.00	2,501.00	2,467.00	2,263.00
45HW Keyless, deadbolt, fail secure	LEU	N/A	N/A	N/A	2,101.00
45HW Keyless, deadbolt, fail safe	LEL	N/A	N/A	N/A	2,101.00

* Patented pricing shown is for CORMAX patented keying system. Add \$20.00 for BEST Preferred patented keying.

Extra Cost Options*	Option Code	Add-On
Satin finishes (per lock)	606, 612, 613, 619 etc.	50.00
Bright finishes (per lock)	605, 611, 625, etc.	89.00
UltraShield antimicrobial finish	626AM, 630AM	94.00
Wrought trim	J	22.00
Thick door	Specify thickness	127.00
Lead lined	LL	340.00
Forged trim	M, N	142.00
7/8" Lip-to-center strike	7/8 LTC	35.00
12, 17 Lever Design	12, 17	100.00
Vandal trim - 630 finish***	VT	218.00
Vandal trim - other finishes***	VT	169.00
Visual Indicator	VIN	67.00

**Not available on #17 levers.

***Available only with #14 and #15 levers.

Only #14 lever complies with California State Fire Marshall Code.

****gives both RQE and DS options in one

Extra Cost Options*	Option Code	Add-On
Request to exit	RQE	66.00
Integrated door hardware****	IDH	182.00
Latch status monitor	LS	133.00
Door status monitor	DS	182.00
Tactile both levers/knobs**	TAC/B	177.00
Tactile outside lever/knob**	TAC/O	94.00
Tactile inside lever/knob**	TAC/I	94.00
Decorative Lever Design	50 to 91	309.00
Security Head Screws	SH	35.00

**Cost Deductions	Option Code	Deduct
Less cylinder option (Deduct from complete price)	0	81.00

47HW Series High Security Electromechanical Mortise Locks

Electromechanical Locks

How To Order

Series	Core Housing	Function Code	Lever Style	Trim Style	Finish	Door Hand	Options
47HW	7 – 7-pin housing; accepts all BEST cores	DEL TDEL TWEL WEL DEU TDEU TWEU WEU	Levers: 3 – Solid tube/return 12* – Solid tube/no return 14 – Curved/return 15 – Contour/angle return 16 – Curved/no return 17* – Gull wing Knobs: 4 – Round Decorative**** 50-91	M – forged H***** – 2-3/4" dia. R***** – 2-3/4" dia. S***** – 3-1/2" dia.	626 630 626AM* 630AM*	RH RHR LH LHR	C* – Pre-Terminated Quick Connect Plug DS* – Door status monitor IDH* – Integrated Door Hardware LS* – Latch status monitor ROE* – Request to exit Thick door* – [Specify thickness] 7/8** – Flat lip strike VT* – Vandal Trim 12V – 12V Solenoid (24V is standard) K – Non-UL Cylinder TAC/I* – Tactile Lever Inside TAC/O* – Tactile lever Outside TAC/B* – Tactile Lever Both LL* – Lead Lined

* Indicates extra cost, see below.

** Indicates cost deduction, see below.

*** Fail safe functions (EL) and fail secure functions (EU) include a Temperature Control Module (TCM) with the price of the lock.

**** Decorative levers are considered special order items that may have extended lead times. Consult factory for lead times. Available decorative levers: 50-53, 55, 60, 62-63, 65, 69, 75, 79-81, and 89.

***** To maintain the UL437 standard for high security locks, order only M trim. Using H, R or S trim does not meet the UL437 standard.

+ See BEST Hinges & Door Accessories price book for Wire Harness product

Function Description	Function Code	Complete With Combined Core			Less Core
		Patented*	Premium	Standard	
47HW Electromechanical:					
47HW Single key, latch, fail secure	DEU	2,130.00	N/A	2,129.00	NOTE: 47HW Series must be keyed at the factory unless the K Option is ordered
47HW Single key, latch, fail safe	DEL	2,130.00	N/A	2,129.00	
47HW Double key, latch, fail secure	WEU	2,424.00	N/A	2,422.00	
47HW Double key, latch, fail safe	WEL	2,424.00	N/A	2,422.00	
47HW Single key, deadbolt, fail secure	TDEU	2,170.00	N/A	2,169.00	
47HW Single key, deadbolt, fail safe	TDEL	2,170.00	N/A	2,169.00	
47HW Double key, deadbolt, fail secure	TWEU	2,450.00	N/A	2,448.00	
47HW Double key, deadbolt, fail safe	TWEL	2,450.00	N/A	2,448.00	

* Patented pricing shown is for CORMAX patented keying system. Add \$20.00 for BEST Preferred patented keying.

Extra Cost Options*		Add-On
Thick door	Specify thickness	127.00
7/8" Lip-to-center strike	7/8 LTC	35.00
12, 17 Lever Design	12, 17	100.00
UltraShield antimicrobial finish	626AM, 630AM	94.00
Decorative Lever Design	50-91	309.00
Vandal trim - 630 finish***	VT	218.00
Vandal trim - other finishes***	VT	169.00
Request to exit	ROE	66.00
Integrated door hardware	IDH	182.00
Latch status monitor	LS	133.00
Door status monitor	DS	182.00
Lead Lined	LL	340.00

*** Available only with #14 and #15 levers.

Only #14 lever complies with California State Fire Marshall Code.

Extra Cost Options*	Option Code	Add-On
Tactile both levers/knobs**	TAC/B	177.00
Tactile outside lever/knob**	TAC/O	94.00
Tactile inside lever/knob**	TAC/I	94.00

Security Head Screws provided stanadard on 47HW.

**Not available on #17 levers.

ATTENTION: Locksets that secure both sides of the door (e.g. WEL & WEU) are controlled by building codes and the Life Safety Code. Delay in unlocking for rapid emergency exit could be hazardous or even fatal.

8KW/9KW Series Electromechanical Cylindrical Locks

Electromechanical Locks

How To Order

8KW	3	7	DEL	4	C	STK	626	
Series	Backset	Core Housing	Function Code	Knob Style	Rose Style	Strike Package	Finish	Options
8KW	3 – 2-3/4" 4* – 3-3/4" 5* – 5"	7 – 7-pin housing; accepts all BEST cores	DEL** – Electrically locked DEU** – Electrically unlocked	4 – Round 6 – Tulip	C – 3" convex D – 3-1/2" convex K – 3" convex L – 3-1/2" convex	STK – Standard S3 – ANSI	626 690 626AM* Satin* 606 612 613 619 622 Bright* 605 611 625	BRK – Break-away (keyed only) C* – Pre-Terminated Quick Connect Plug LL* – Lead lined SH* – Security head screws 3/4* – 3/4" throw RQE* – Request to Exit Thin Door* – 1-3/8" TAC/I* – Tactile Lever Inside TAC/O* – Tactile lever Outside TAC/B* – Tactile Lever Both 12V – Specify 12V System: Standard voltage is 24V

* Indicates extra cost, see below.

** Fail safe functions (EL) and fail secure functions (EU) include a Temperature Control Module (TCM) with the price of the lock.

+ See BEST Hinges & Door Accessories price book for Wire Harness product

9KW	3	7	DEL	15	C	S3	626	
Series	Backset	Core Housing	Function Code	Lever Style	Rose Style	Strike Package	Finish	Options
9KW	3 – 2-3/4" 4* – 3-3/4" 5* – 5"	0*** – Non- IC and LFIC competitive cylinder (less core) 6** – 6 pin Non-IC Cylinder 7 – 7-pin Housing; accepts all BEST cores	DEL – Electrically locked**** DEU – Electrically unlocked****	14 – Curved with return 15 – Contour with angle return 16 – Curved with no return	C – 3" convex D – 3-1/2" convex K – 3" convex no ring L – 3-1/2" convex no ring	STK – Standard S3 – ANSI S3 7/8* – 7/8 Lip to Center strike LS – Less Strike S3B* – ANSI (Stike w/ Plastic Box) S3B 7/8* – ANSI (Stike w/ Plastic Box)	626 690 626AM* Satin* 606 612 613 619 622 Bright* 605 611 625	3/4* – 3/4" throw latch ATB – 2-3/4" Through bolt Prep ATB2 – 2-5/8" Through bolt prep C* – Pre-Terminated Quick Connect Plug LL* – Lead lined SH* – Security head screws LM – Lost motion RQE* – Request to Exit Thin Door* – 1-3/8" AL/O* – Abrasive Lever Outside AL/I* – Abrasive Lever Inside AL/B* – Abrasive Lever Both TL/O* – Tactile Lever Outside TL/I* – Tactile Lever Inside TL/B* – Tactile Lever Both FRL – Full Radius Latch OB** – Non-IC zero-bitted KA** – Non-IC keyed alike KD** – Non-IC keyed different COR*** – Non-IC Corbin-Russwin MED*** – Non-IC Medeco SAR*** – Non-IC Sargent SCH*** – Non-IC Schlage YAL*** – Non-IC Yale SARRC*** – LFIC Sargent CORRC*** – LFIC Corbin YALRC*** – LFIC Yale SCHRC*** – LFIC Schlage (14 & 15 lever only) 12V – Specify 12V System: Standard voltage is 24V

* Indicates extra cost option.

** Six-pin cylinder in Schlage "C" keyway included with OB, KA, and KD options. Must specify "6" for core housing.

*** Cylinder not included with COR, MED, SAR, SCH, YAL, CORRC, YALRC, SARRC, or SCHRC options. Must specify "0" for core housing.

**** Fail safe functions (EL) and fail secure functions (EU) include a Temperature Control Module (TCM) with the price of the lock.

8KW/9KW Series Electromechanical Cylindrical Locks (cont.)

Electromechanical Locks

Function Description	Function Code	Complete With Combined Core			Less Core	6-pin non-IC Cylinder OB, KA, KD
		Patented*	Premium	Standard		
Electromechanical:						
8KW Elect. locked / unlocked	DEL, DEU	1,729.00	1,729.00	1,712.00	1,610.00	N/A
9KW Elect. locked / unlocked	DEL, DEU	1,547.00	1,547.00	1,530.00	1,428.00	1,508.00

*Patented pricing shown is for CORMAX patented keying system. Add \$20.00 for BEST Preferred patented keying.

Extra Cost Options*	Option Code	Add-On
Satin finishes (per lock)	606, 612, 613, etc.	32.00
Bright finishes (per lock)	605, 611, 625, 629, etc.	66.00
UltraShield antimicrobial finish	626AM	90.00
Thin door 1-3/8"	1-3/8"	120.00
3/4" throw latch	3/4	50.00
Special backsets	84K / 85K / 94K / 95K	34.00
Lead lined	LL	334.00
Security head screws	SH	35.00
Tactile knob both sides	TAC/B	126.00
Tactile knob outside	TAC/O	66.00
Tactile knob inside	TAC/I	66.00
Abrasive lever both sides	AL/B	66.00
Abrasive lever outside	AL/O	35.00
Abrasive lever inside	AL/I	35.00
Tactile lever both sides	TL/B	126.00
Full radius latch	FRL	34.00
Tactile lever outside	TL/O	66.00
Tactile lever inside	TL/I	66.00
7/8" Lip-to-center strike	S3 7/8	35.00
Strike with plastic box	S3B or S3B 7/8	3.50
Request to exit	ROE	247.00

NOTE: These options do not come with a cylinder. The lock is just prepped for cylinders of these other manufacturers and comes with a throw member for that manufacturer's cylinder.

Extra Cost Options*	Option Code	Add-On
Non-IC Corbin-Russwin (single keyed)	COR	10.00
Non-IC Corbin-Russwin (double keyed)	COR	26.00
Non-IC Medeco (single keyed)	MED	10.00
Non-IC Medeco (double keyed)	MED	26.00
Non-IC Sargent (single keyed)	SAR	10.00
Non-IC Sargent (double keyed)	SAR	26.00
Non-IC Schlage (single keyed)	SCH	10.00
Non-IC Schlage (double keyed)	SCH	26.00
Non-IC Yale (single keyed)	YAL	10.00
Non-IC Yale (double keyed)	YAL	26.00

NOTE: These options do not come with a cylinder. The lock is just prepped for cylinders of these other manufacturers and comes with a throw member for that manufacturer's cylinder.

Parts Description	Part Number	Price
2-3/4" deadlocking latch	8KL3	119.00
3-3/4" deadlocking latch	8KL4	148.00
5" deadlocking latch	8KL5	148.00
Standard strike package	8KS2	13.00
ANSI strike package	8KS3	38.00
8KW Throw member 6-pin / 7-pin	B92506	4.10
9KW Throw member 6-pin / 7-pin	B92505	4.10
Breakaway knob driver	B54856	14.00

Electromechanical Lock Accessories

Description	Catalog Number	Price
Transformer	8W599	242.00
AC to DC converter	8WCON	98.00
Narrow plate (push button)	8WBU-1-N	165.00
Standard plate (push button)	8WBU-1-A	165.00
Universal temperature control module	8WTCM	264.00

45HZ Keypad EZ Mortise Locks

How To Order

Series	Core Housing	Function Code	Lever Style	Trim Style	Finish	Door Hand	Options
45HZ	7	TV	15	KP	626	RH	
45HZ	0** – Less Core Housing 7 – 7-pin housing; accepts all BEST cores	DV – Latch with key TV – Deadbolt with key NV – Latch without key LV – Deadbolt without key	Levers: 3 – Solid tube/return 12* – Solid tube/no return 14 – Curved/return 15 – Contour/angle return 16 – Curved/no return 17* – Gull wing 4 – Round Knob Decorative* 50–91	KP – Keypad KG – Keypad with inside trim passage toggle button	626 690 626AM* – Antimicrobial Satin* 606 612 613 619 622 Bright* 605 611 618 625	RH RHRB LH LHRB	8CE* – 8-cell battery holder assy with batteries 4SW – 4-cell shrink wrap battery P2*** – Phillips head screws Thick Door* – Specify thickness 7/8** – Flat lip strike TAC/I* – Tactile Lever Inside TAC/O* – Tactile lever Outside TAC/B* – Tactile Lever Both WS – Windstorm Label (Florida Building Code)

* Indicates extra cost, see below.

** Fail safe functions (EL) and fail secure functions (EU) include a Temperature Control Module (TCM) with the price of the lock.

+ See BEST Hinges & Door Accessories price book for Wire Harness product

Description	Function Code	Complete With Combined Core			Less Core
		Patented*	Premium	Standard	
Keypad EZ Mortise Locks:					
45HZ - Single Keyed Latch	DV	1,995.00	1,995.00	1,978.00	1,876.00
45HZ - Single Keyed Deadbolt	TV	2,036.00	2,036.00	2,019.00	1,917.00
45HZ - Non-keyed Latch	NV	N/A	N/A	N/A	1,795.00
45HZ - Non-keyed Deadbolt	LV	N/A	N/A	N/A	1,836.00

* Patented pricing shown is for CORMAX patented keying system. Add \$20.00 for BEST Preferred patented keying.

Extra Cost Options*	Option Code	Add-On
Satin finishes (per lock)	606, 612, 613, 619 etc.	89.00
Bright finishes (per lock)	605, 611, 625, etc.	171.00
UltraShield antimicrobial finish	626AM	187.00
Thick door	Specify thickness	127.00
Tactile both levers/knobs**	TAC/B	177.00
Tactile outside lever/knob**	TAC/O	94.00
Tactile inside lever/knob**	TAC/I	94.00
7/8" Lip-to-center strike	7/8 LTC	35.00
12, 17 Lever Design	12, 17	100.00
Decorative Lever Design	50-91	309.00
Extended Life Battery	8CE	102.00

** Not available on #17 levers.

**Cost Deductions	Option Code	Deduct
Less cylinder option (Deduct from complete price)	0	81.00

9KZ Keypad EZ Cylindrical Locks

Electromechanical Locks

How To Order

9KZ	3	7	DV	15	KP	STK	626	
Series	Backset	Core Housing	Function Code	Lever Style	Trim Style	Strike Package	Finish	Options
9KZ	3 – 2-3/4" 4* – 3-3/4" 5* – 5"	0*** – Non-IC and LFIC competitive cylinder (less core) 6** – 6 pin non-IC cylinder 7 – 7-pin housing; accepts all BEST cores	DV – With Key	14 – Curved with return 15 – Contour angle return 16 – Curved with no return 4 – Round Knob	KP – Keypad KG – Keypad with inside trim passage toggle button	STK – Standard S3 – ANSI S3 – 7/8" Lip to Center Strike S3B* – ANSI (Strike w/ Plastic Box) S3B 7/8* – ANSI (Strike w/ Plastic Box)	626 690 626AM* Satin* 606 612 613 619 622 Bright* 605 611 618 625	8CE* – 8 cell battery holder assy with batteries 4SW – 4 cell shrink wrap battery P2**** – Phillips head screws LM – Lost motion 3/4* – 3/4" throw latch FRL – Full Radius Latch OB* – non-IC zero-bitted KA* – non-IC keyed alike KD* – non-IC keyed different COR*** – Non IC Corbin–Russwin MED*** – Non IC Medeco SAR*** – Non IC Sargent SCH*** – Non IC Schlage YAL*** – Non IC Yale SARRC*** – LFIC Sargent CORRC*** – LFIC Corbin YALRC*** – LFIC Yale SCHRC*** – LFIC Schlage AL/O* – Abrasive Lever Outside AL/I* – Abrasive Lever Inside AL/B* – Abrasive Lever Both TL/O* – Tactile Lever Outside TL/I* – Tactile Lever Inside TL/B* – Tactile Lever Both WS – Windstorm Label (Florida Building Code)

* Indicates extra cost option.

** Six-pin cylinder in Schlage "C" keyway included with OB, KA, and KD options. Must specify "6" for core housing.

*** Cylinder not included with COR, MED, SAR, SCH, YAL, or SCHRC options. Must specify "0" for core housing.

**** T15 Torx security screws are supplied standard.

Function Description	Function Code	Complete With Combined Core			Less Core	6-pin non-IC Cylinder OB, KA, KD
		Patented*	Premium	Standard		
Keypad EZ Cylindrical Lock:						
9KZ - Single keyed lock	DV	1,711.00	1,711.00	1,694.00	1,592.00	1,672.00

*Patented pricing shown is for CORMAX patented keying system. Add \$20.00 for BEST Preferred patented keying.

Extra Cost Options*	Option Code	Add-On
Satin finishes (per lock)	606, 612, 613, etc.	89.00
Bright finishes (per lock)	605, 625, 629, etc.	171.00
UltraShield antimicrobial finish	626AM	187.00
3/4" throw latch	3/4	50.00
Special backsets	94KZ / 95KZ	34.00
Abrasive lever both sides	AL/B	66.00
Abrasive lever outside	AL/O	35.00
Abrasive lever inside	AL/I	35.00
Tactile lever both sides	TL/B	126.00
Tactile lever outside	TL/O	66.00
Tactile lever inside	TL/I	66.00
Full radius latch	FRL	34.00
7/8" Lip-to-center strike	S3 7/8	35.00
Strike with plastic box	S3B or S3B 7/8	3.50
Extended Life Battery	8CE	102.00

Extra Cost Options*	Option Code	Add-On
Non-IC Corbin–Russwin (single keyed)	COR	10.00
Non-IC Medeco (single keyed)	MED	10.00
Non-IC Sargent (single keyed)	SAR	10.00
Non-IC Schlage (single keyed)	SCH	10.00
Non-IC Yale (single keyed)	YAL	10.00

NOTE: These options do not come with a cylinder. The lock is just prepped for cylinders of these other manufacturers and comes with a throw member for that manufacturer's cylinder.

Part Description	Part Number	Price
2-3/4" deadlocking latch	8KL3	119.00
3-3/4" deadlocking latch	8KL4	148.00
5" deadlocking latch	8KL5	148.00
Standard strike package	8KS2	13.00
ANSI strike package	8KS3	38.00
Throw member 6-pin / 7-pin	B92505	4.10

EXZ Keypad EZ Exit Trim

How To Order

EXZ	7	EV	15	KP	626	RHR	PH2	RM	
Series	Core Housing	Function Code	Lever Style	Trim Style	Finish	Door Hand	Manf.	Locking Type	Options
EXZ	0 – Less Core Housing 7 – 7-pin housing; accepts all BEST cores	EV – With key** NV – Without key	14 – Curved w/ return 15 – Contour w/ angle return	KP – Key Pad	626 690 626AM* Satin* 606 613	RHR LHR	VD9** – Von Duprin 98/99 series PH2 – Precision Hardware 2000 series SA8 – Sargent 8000 Series***	RM – Rim MO – Mortise RD – Surface and concealed vertical rods	SH* – Security head screws

*Indicates extra cost option; see below.

**The EV function (key override) is not available on the Von Duprin Mortise type.

***SA8 Only available with Rim Type device. SA8 does not work with EV function (Key Override).

Function Description	Function Code	Complete With Combined Core			Less Core
		Patented*	Premium	Standard	
Keypad EZ Exit Trim Locks:					
EXZ - Exit Trim - single keyed	EV	2,607.00	2,607.00	2,590.00	2,488.00
EXZ - Exit Trim - non keyed	NV	N/A	N/A	N/A	2,407.00

*Patented pricing shown is for CORMAX patented keying system. Add \$20.00 for BEST Preferred patented keying.

Extra Cost Options*	Option Code	Add-On
Satin finishes (per lock)	606, 613, etc.	89.00
UltraShield antimicrobial finish	626AM	187.00
Security head screws	SH	35.00

45HG Offline G Series Mortise Locks

Electromechanical Locks

How To Order

Series	Core Housing	Function Code	Lever Style	Trim Style	Finish	Door Hand	Options
45HG	7	TV	14	MS	626	RH	
45HG	0** – Less Core Housing 7 – 7-pin housing; accepts all BEST cores	DV – Latch w/key TV – Deadbolt w/key LV – Deadbolt w/o key NV – Latch w/o key	Levers: 3 – Solid tube/return 12* – Solid tube/no return 14 – Curved/return 15 – Contour/angle return 16 – Curved/no return 17* – Gull wing Knobs: 4 – Round Decorative* 50–91	MS**** – Magnetic stripe DV**** – Dual validation (magstripe and keypad) DVA**** – Other cylinder MSA**** – Other cylinder	626 690 626AM* Satin* 606 612 613 619 Bright* 605 611 625	RH RHR LH LHR	8CE* – 8 cell battery holder assy with batteries 4SW – 4 cell shrink wrap battery P2**** – Phillips head screws KOS* – Key override sensor Thick Door* – Specify thickness 7/8*** – Flat lip strike TAC/I* – Tactile Lever Inside TAC/O* – Tactile lever Outside TAC/B* – Tactile Lever Both TRK1**** – Track 1 TRK2**** – Track 2 TRK3**** – Track 3 WS – Windstorm Label (Florida Building Code)

*Indicates extra cost option.

**Indicates cost deduction.

***T15 Torx security screws are supplied standard.

****Must specify track number.

Function Description	Function Code	Complete With Combined Core			Less Core
		Patented*	Premium	Standard	
Magnetic Stripe Reader:					
45HG - Single Keyed Latch	DV	2,429.00	2,429.00	2,412.00	2,310.00
45HG - Single Keyed Deadbolt	TV	2,475.00	2,475.00	2,458.00	2,356.00
45HG - Non-keyed Latch	NV	N/A	N/A	N/A	2,229.00
45HG - Non-keyed Deadbolt	LV	N/A	N/A	N/A	2,275.00
Mag Stripe/Keypad Dual Validation Reader:					
45HG - Single Keyed Latch	DV	2,726.00	2,726.00	2,709.00	2,607.00
45HG - Single Keyed Deadbolt	TV	2,780.00	2,780.00	2,763.00	2,661.00
45HG - Non-keyed Latch	NV	N/A	N/A	N/A	2,526.00
45HG - Non-keyed Deadbolt	LV	N/A	N/A	N/A	2,580.00

*Patented pricing shown is for CDRMAX patented keying system. Add \$20.00 for BEST Preferred patented keying.

Extra Cost Options*	Option Code	Add-On
Satin finishes (per lock)	606, 612, 613, 619 etc.	89.00
Bright finishes (per lock)	605, 611, 625, etc.	171.00
UltraShield antimicrobial finish	626AM	187.00
Thick door	Specify thickness	127.00
Tactile both levers/knobs**	TAC/B	177.00
Tactile outside lever/knob**	TAC/O	94.00
Tactile inside lever/knob**	TAC/I	94.00
7/8" Lip-to-center strike	7/8 LTC	35.00
12, 17 Lever Design	12, 17	100.00
Decorative Lever Design	50-91	309.00
Extended Life Battery	8CE	102.00
Key Override Sensor	KOS	56.00

**Not available on #17 levers.

**Cost Deductions	Option Code	Deduct
Less cylinder option (Deduct from complete price)	0	81.00

9KG Offline G Series Cylindrical Locks

Electromechanical Locks

How To Order

9KG	3	7	DV	14	MS	STK	626	
Series	Backset	Core Housing	Function Code	Lever Style	Rose Style	Strike Package	Finish	Options
9KG	3 – 2-3/4" 4* – 3-3/4" 5* – 5"	0*** – Non-IC and LFIC competitive cylinder (less core) 6** – 6 pin non-IC cylinder 7 – 7-pin housing; accepts all BEST cores	DV – with key	4 – Round knob 14 – Curved with return 15 – Contour with angle return 16 – Curved without return	MS***** – Magnetic stripe DV***** – Dual validation (magstripe and keypad)	STK – Standard S3 – ANSI S3 – 7/8" Lip to Center Strike S3B* – ANSI (Strike w/ Plastic Box) S3B 7/8* – ANSI (Strike w/ Plastic Box)	626 690 626AM* Satin* 606 612 Bright* 605 625	8CE* – 8 cell battery holder assy with batteries 4SW – 4 cell shrink wrap battery P2***** – Phillips head screws LM – Lost Motion 3/4* – 3/4" throw latch OB** – non-IC zero-bitted KA** – non-IC keyed alike KD** – non-IC keyed different COR*** – Non IC Corbin-Russwin MED*** – Non IC Medeco SAR*** – Non IC Sargent SCH*** – Non IC Schlage YAL*** – Non IC Yale SARRC*** – LFIC Sargent CORRC*** – LFIC Corbin YALRC*** – LFIC Yale SCHRC*** – LFIC Schlage AL/O* – Abrasive Lever Outside AL/I* – Abrasive Lever Inside AL/B* – Abrasive Lever Both TL/O* – Tactile Lever Outside TL/I* – Tactile Lever Inside TL/B* – Tactile Lever Both FRL – Full Radius Latch TRK1***** – Track 1 TRK2***** – Track 2 TRK3***** – Track 3 WS – Windstorm Label (Florida Building Code)

*Indicates extra cost option.
 ** Six-pin cylinder in Schlage "C" keyway included with OB, KA, KD options. Must specify "6" for core housing.
 *** Cylinder not included with COR, MED, SAR, SCH, YAL, CORRC, YALRC, SARRC, or SCHRC options. Must specify "0" for core housing.
 **** T15 Torx security screws are supplied standard.
 ***** Must specify track number.

Function Description	Function Code	Complete with combined core			Less Core	6-pin non-IC Cylinder OB, KA, KD
		Patented*	Premium	Standard		
Magnetic Stripe Reader:						
9KG - Single keyed lock	DV	2,212.00	2,212.00	2,195.00	2,093.00	2,173.00
Mag Stripe/Keypad Dual Validation Reader:						
9KG - Single keyed lock	DV	2,527.00	2,527.00	2,510.00	2,408.00	2,488.00

*Patented pricing shown is for CORMAX patented keying system. Add \$20.00 for BEST Preferred patented keying.

Extra Cost Options*	Option Code	Add-On
Satin finishes (per lock)	606, 612, 613, etc.	89.00
Bright finishes (per lock)	605, 625, 629, etc.	171.00
UltraShield antimicrobial finish	626AM	187.00
3/4" throw latch	3/4	50.00
Special backsets	94KG / 95KG	34.00
Abrasive lever both sides	AL/B	66.00
Abrasive lever outside	AL/O	35.00
Abrasive lever inside	AL/I	35.00
Tactile lever both sides	TL/B	126.00
Tactile lever outside	TL/O	66.00
Tactile lever inside	TL/I	66.00
Full radius latch	FRL	34.00
7/8" Lip-to-center strike	S3 7/8	35.00
Strike with plastic box	S3B or S3B 7/8	3.50
Extended Life Battery	8CE	102.00

Extra Cost Options*	Option Code	Add-On
Non-IC Corbin-Russwin (single keyed)	COR	10.00
Non-IC Medeco (single keyed)	MED	10.00
Non-IC Sargent (single keyed)	SAR	10.00
Non-IC Schlage (single keyed)	SCH	10.00
Non-IC Yale (single keyed)	YAL	10.00

NOTE: These options do not come with a cylinder. The lock is just prepped for cylinders of these other manufacturers and comes with a throw member for that manufacturer's cylinder.

Part Description	Part Number	Part Price
2-3/4" deadlocking latch	8KL3	119.00
3-3/4" deadlocking latch	8KL4	148.00
5" deadlocking latch	8KL5	148.00
Standard strike package	8KS2	13.00
ANSI strike package	8KS3	38.00
Throw member 6-pin / 7-pin	B92505	4.10

EXG Offline G Series Exit Trim

How To Order

Series	Core Housing	Function Code	Lever Style	Trim Style	Finish	Door Hand	Manf.	Locking Type	Options
EXG	0 – Less Core Housing 7 – 7-pin housing, accepts all BEST cores	EV – With key** NV – Without key	14 – Curved w/ return 15 – Contour w/ angle return	MS**** – Magnetic stripe DV**** – Dual validation (magstripe and keypad)	626 690 626AM* Satin* 606 613	RHR LHR	VD9** – Von Duprin 98/99 series PH2 – Precision Hardware 2000 series SA8 – Sargent 8000 Series***	RM – Rim*** MO – Mortise RD – Surface and concealed vertical rods	SH* – Security head screws TRK1**** – Track 1 TRK2**** – Track 2 TRK3**** – Track 3

*Indicates extra cost option; see below.

**The EV function (key override) is not available on the Von Duprin Mortise type.

***SA8 Only available with Rim Type device. SA8 does not work with EV function (Key Override).

****Must specify track number.

Function Description	Function Code	Complete With Core			Less Core List Price
		Patented*	Premium	Standard	
Magnetic Stripe Reader:					
EXG - Exit Trim - single keyed	EV	2,960.00	2,960.00	2,943.00	2,841.00
EXG - Exit Trim - non keyed	NV	N/A	N/A	N/A	2,760.00
Mag Stripe/Keypad Dual Validation Reader:					
EXG - Exit Trim - single keyed	EV	3,272.00	3,272.00	3,255.00	3,153.00
EXG - Exit Trim - non keyed	NV	N/A	N/A	N/A	3,072.00

Extra Cost Options*	Option Code	Add-On
Satin finishes (per lock)	606,613, etc.	89.00
UltraShield antimicrobial finish	626AM	187.00
Security head screws	SH	35.00

*Patented pricing shown is for CORMAX patented keying system. Add \$20.00 for BEST Preferred patented keying.

45HBV Offline V Series Mortise Locks

Electromechanical Locks

How To Order

Series	Core Housing	Function Code	Lever Style	Trim Style	Finish	Door Hand	Options
45HBV	7	TV	14	MS	626	RH	
45HBV	0** – Less Core Housing 7 – 7-pin housing; accepts all BEST cores	DV – Latch w/key TV – Deadbolt w/key LV – Deadbolt w/o key NV – Latch w/o key	Levers: 3 – Solid tube/return 12* – Solid tube/no return 14 – Curved/return 15 – Contour/angle return 16 – Curved/no return 17* – Gull wing Knobs: 4 – Round Decorative* 50 –91	MS**** – Magnetic stripe DV**** – Dual validation (magstripe and keypad) DVA**** – Dual Validation Adaptation PH – Proximity HID® PHA – Prox HID® Adaptation MSA**** – Magstripe Adaptation PKP – Proximity+Keypad PKPA – Proximity+Keypad adaptation SE – iCLASS SEA – iCLASS smartcard adaptation PSEBH – Proximity + SE + HID BLE PSEBHA – Proximity + SE + HID BLE Adaptation	626 630 690 626AM* 630AM* Satin* 606 612 613 619 Bright* 605 611 625 629	RH RHR LH LHR	8CE* – 8 cell battery holder assy with batteries 4SW – 4 cell shrink wrap battery P2*** – Phillips head screws KOS* – Key override sensor Thick Door* – Specify thickness 7/8** – Flat lip strike TAC/I* – Tactile Lever Inside TAC/O* – Tactile lever Outside TAC/B* – Tactile Lever Both TRK1**** – Track 1 TRK2**** – Track 2 TRK3**** – Track 3 MWIE – Motorola 26 bit Wiegand H26B – HID 26 bit Wiegand H37B – HID 37 bit Wiegand WS – Windstorm Label (Florida Building Code)

*Indicates extra cost option.
 **Indicates cost deduction.
 ***T15 Torx security screws are supplied standard.
 ****Must specify track number.

Function Description	FunctionCode	Complete With Combined Core			Less Core
		Patented	Premium	Standard	
Magnetic Stripe Reader:					
45HBV - Single Keyed Latch	DV	2,805.00	2,805.00	2,788.00	2,686.00
45HBV - Single Keyed Deadbolt	TV	2,835.00	2,835.00	2,818.00	2,716.00
45HBV - Non-keyed Latch	NV	N/A	N/A	N/A	2,609.00
45HBV - Non-keyed Deadbolt	LV	N/A	N/A	N/A	2,638.00
Mag Stripe/Keypad Dual Validation Reader:					
45HBV - Single Keyed Latch	DV	3,102.00	3,102.00	3,085.00	2,983.00
45HBV - Single Keyed Deadbolt	TV	3,104.00	3,104.00	3,087.00	2,985.00
45HBV - Non-keyed Latch	NV	N/A	N/A	N/A	2,905.00
45HBV - Non-keyed Deadbolt	LV	N/A	N/A	N/A	2,908.00
HID Proximity Reader:					
45HBV - Single Keyed Latch	DV	3,773.00	3,773.00	3,756.00	3,654.00
45HBV - Single Keyed Deadbolt	TV	3,808.00	3,808.00	3,791.00	3,689.00
45HBV - Non-keyed Latch	NV	N/A	N/A	N/A	3,577.00
45HBV - Non-keyed Deadbolt	LV	N/A	N/A	N/A	3,612.00
PKP - Proximity + Keypad Reader:					
45HBV - Single Keyed Latch	DV	2,547.00	2,547.00	2,530.00	2,428.00
45HBV - Single Keyed Deadbolt	TV	2,567.00	2,567.00	2,550.00	2,448.00
45HBV - Non-keyed Latch	NV	N/A	N/A	N/A	2,357.00
45HBV - Non-keyed Deadbolt	LV	N/A	N/A	N/A	2,377.00
SE - HID® iCLASS® Smart Card Reader:					
45HBV - Single Keyed Latch	DV	2,705.00	2,705.00	2,688.00	2,586.00
45HBV - Single Keyed Deadbolt	TV	2,707.00	2,707.00	2,690.00	2,588.00
45HBV - Non-keyed Latch	NV	N/A	N/A	N/A	2,515.00
45HBV - Non-keyed Deadbolt	LV	N/A	N/A	N/A	2,517.00
PSEBH - Proximity + SE + HID BLE					
45HBV - Single Keyed Latch	DV	3,889.00	3,889.00	3,872.00	3,770.00
45HBV - Single Keyed Deadbolt	TV	3,891.00	3,891.00	3,874.00	3,772.00
45HBV - Non-keyed Latch	NV	N/A	N/A	N/A	3,678.00
45HBV - Non-keyed Deadbolt	LV	N/A	N/A	N/A	3,680.00

*Patented pricing shown is for CORMAX patented keying system. Add \$20.00 for BEST Preferred patented keying.

45HBV Offline V Series Mortise Locks (continued)

Electromechanical Locks

Extra Cost Options*	Option Code	Add-on
Satin finishes (per lock)	606, 612, 613, 619 etc.	89.00
Bright finishes (per lock)	605, 611, 625, etc.	171.00
UltraShield antimicrobial finish	626AM, 630AM	187.00
Thick door	Specify thickness	127.00
Tactile both levers/knobs**	TAC/B	177.00
Tactile outside lever/knob**	TAC/O	94.00
Tactile inside lever/knob**	TAC/I	94.00
Security head screws	SH	35.00
7/8" Lip-to-center strike	7/8 LTC	35.00
12, 17 Lever Design	12, 17	100.00
Decorative Lever Design	50-91	309.00
Extended Life Battery	8CE	102.00
Key Override Sensor	KOS	56.00

*Not available on #17 levers.

**Cost Deductions	Option Code	Deduct
Less cylinder option (Deduct from complete price)	0	81.00

*Patented pricing shown is for CORMAX patented keying system. Add \$20.00 for BEST Preferred patented keying.

9KBV Offline V Series Cylindrical Locks

How To Order

Series	Backset	Core Housing	Function Code	Lever Style	Rose Style	Strike Package	Finish	Options
9KBV	3: 2-3/4" 4*: 3-3/4" 5*: 5"	0*** – Non-IC and LFIC competitive cylinder (less core) 6** – 6 pin non-IC cylinder 7 – 7-pin housing; accepts all BEST cores	DV – with key 14 – Curved with return 15 – Contour with angle return 16 – Curved without return	4 – Round knob 14 – Curved with return 15 – Contour with angle return 16 – Curved without return	MS***** – Magnetic stripe DV***** – Dual validation (magstripe and keypad) PH – Proximity HID® PKP – Proximity+Keypad SE – iCLASS PSEBH – Proximity + SE + HID BLE	STK – Standard S3 – ANSI S3 7/8* – Lip to center strike S3B* – ANSI (Strike w/ Plastic Box) S3B 7/8* – ANSI (Strike w/ Plastic Box)	626 690 626AM* Satin* 606 612 Bright* 605 625	8CE* – 8 cell battery holder assy with batteries 4SW – 4 cell shrink wrap battery P2**** – Phillips head screws LM – Lost Motion 3/4* – 3/4" throw latch OB** – non-IC zero-bitted KA** – non-IC keyed alike KD** – non-IC keyed different COR*** – Non IC Corbin-Russwin MED*** – Non IC Medeco SAR*** – Non IC Sargent SCH*** – Non IC Schlage YAL*** – Non IC Yale SARRC*** – LFIC Sargent CORRC*** – LFIC Corbin YALRC*** – LFIC Yale SCHRC*** – LFIC Schlage AL/O* – Abrasive Lever Outside AL/I* – Abrasive Lever Inside AL/B* – Abrasive Lever Both TL/O* – Tactile Lever Outside TL/I* – Tactile Lever Inside TL/B* – Tactile Lever Both FRL – Full Radius Latch TRK1***** – Track 1 TRK2***** – Track 2 TRK3***** – Track 3 MWIE – Motorola 26 bit Wiegand H26B – HID 26 bit Wiegand H37B – HID 37 bit Wiegand WS – Windstorm Label (Florida Building Code)

* Indicates extra cost option.

** Six-pin cylinder in Schlage "C" keyway included with OB, KA, KD options. Must specify "6" for core housing.

*** Cylinder not included with COR, MED, SAR, SCH, YAL, or SCHRC options. Must specify "0" for core housing.

**** T15 Torx security screws are supplied standard.

***** Must specify track number.

9KBV Offline V Series Cylindrical Locks (continued)

Electromechanical Locks

Description	Function Code	Complete With Combined Core			Less Core	6-pin non-IC Cylinder 0B, KA, KD
		Patented*	Premium	Standard		
Magnetic Stripe Reader:						
9KBV - Single keyed lock	DV	2,553.00	2,553.00	2,536.00	2,434.00	2,514.00
Mag Stripe/Keypad Dual Validation Reader:						
9KBV - Single keyed lock	DV	2,849.00	2,849.00	2,832.00	2,730.00	2,810.00
HID Proximity Reader:						
9KBV - Single keyed lock	DV	3,529.00	3,529.00	3,512.00	3,410.00	3,490.00
PKP - Proximity + Keypad Reader:						
9KBV - Single keyed lock	DV	3,233.00	3,233.00	3,216.00	3,114.00	3,194.00
SE - HID® iCLASS® Smart Card Reader:						
9KBV - Single keyed lock	DV	3,157.00	3,157.00	3,140.00	3,038.00	3,118.00
PSEBH - Proximity + SE + HID BLE						
9KBV - Single keyed lock	DV	3,580.00	3,580.00	3,563.00	3,461.00	3,541.00

*Patented pricing shown is for CORMAX patented keying system. Add \$20.00 for BEST Preferred patented keying.

Extra Cost Options*	Option Code	Add-On
Satin finishes (per lock)	606, 612, 613, etc.	89.00
Bright finishes (per lock)	605, 625, 629, etc.	171.00
UltraShield antimicrobial finish	626AM	187.00
3/4" throw latch	3/4	50.00
Special backsets	94KBV / 95KBV	34.00
Abrasive lever both sides	AL/B	66.00
Abrasive lever outside	AL/O	35.00
Abrasive lever inside	AL/I	35.00
Tactile lever both sides	TL/B	126.00
Tactile lever outside	TL/O	66.00
Tactile lever inside	TL/I	66.00
Full radius latch	FRL	34.00
7/8" Lip-to-center strike	S3 7/8	35.00
Strike with plastic box	S3B or S3B 7/8	35.00
Extended Life Battery	8CE	102.00
Non-IC Corbin-Russwin (single keyed)	COR	10.00
Non-IC Medeco (single keyed)	MED	10.00
Non-IC Sargent (single keyed)	SAR	10.00
Non-IC Schlage (single keyed)	SCH	10.00
Non-IC Yale (single keyed)	YAL	10.00

NOTE: These options do not come with a cylinder. The lock is just prepped for cylinders of these other manufacturers and comes with a throw member for that manufacturer's cylinder.

Part Description	Part Number	Part Price
2-3/4" deadlocking latch	8KL3	119.00
3-3/4" deadlocking latch	8KL4	148.00
5" deadlocking latch	8KL5	148.00
Standard strike package	8KS2	13.00
ANSI strike package	8KS3	38.00
Throw member 6-pin / 7-pin	B92505	4.10

EXBV Offline V Series Exit Trim

How To Order

Series	Core Housing	Function Code	Lever Style	Trim Style	Finish	Door Hand	Manf.	Locking Type	Options
EXBV	7	EV	15	MS	626 690 626AM* Satin* 606 6I3	RHR LHR	PH2 – Precision Hardware 2000 series VD9** – Von Duprin 98/99 series SA8 – Sargent 8000 Series***	RM – Rim MO – Mortise RD – Surface and concealed vertical rods	SH* – Security head screws TRK1**** – Track 1 TRK2**** – Track 2 TRK3**** – Track 3 MWIE – Motorola 26 bit Wiegand H26B – HID 26 bit Wiegand H37B – HID 37 bit Wiegand

*Indicates extra cost option; see below.

**The EV function (key override) is not available on the Von Duprin Mortise type.

***SA8 Only available with Rim Type device. SA8 does not work with EV function (Key Override).

****Must specify track number.

DESCRIPTION	FUNCTION CODE	COMPLETE WITH COMBINATED CORE			LESS CORE
		PATENTED*	PREMIUM	STANDARD	
Magnetic Stripe Reader:					
EXBV - Exit Trim - single keyed	EV	3,175.00	3,175.00	3,158.00	3,056.00
EXBV - Exit Trim - non keyed	NV	N/A	N/A	N/A	2,975.00
Mag Stripe/Keypad Dual Validation Reader:					
EXBV - Exit Trim - single keyed	EV	3,484.00	3,484.00	3,467.00	3,365.00
EXBV - Exit Trim - non keyed	NV	N/A	N/A	N/A	3,284.00
HID Proximity Reader:					
EXBV - Exit Trim - single keyed	EV	4,180.00	4,180.00	4,163.00	4,061.00
EXBV - Exit Trim - non keyed	NV	N/A	N/A	N/A	3,980.00
PKP - Proximity + Keypad Reader:					
EXBV - Exit Trim - single keyed	EV	3,888.00	3,855.00	3,838.00	3,736.00
EXBV - Exit Trim - non keyed	NV	N/A	N/A	N/A	3,655.00
SE - HID® iCLASS® Smart Card Reader:					
EXBV - Exit Trim - single keyed	EV	3,777.00	3,774.00	3,758.00	3,660.00
EXBV - Exit Trim - non keyed	NV	N/A	N/A	N/A	3,582.00
PSEBH - Proximity + SE + HID BLE					
EXBV - Exit Trim - single keyed	EV	4,217.00	4,202.00	4,185.00	4,083.00
EXBV - Exit Trim - non keyed	NV	N/A	N/A	N/A	3,996.00

*Patented pricing shown is for CORMAX patented keying system. Add \$20.00 for BEST Preferred patented keying.

Extra Cost Options*	Option Code	Add-On
Satin finishes (per lock)	606, 6I3, etc.	89.00
UltraShield antimicrobial finish	626AM	187.00
Security head screws	SH	35.00

45HM IDH MAX™ Mortise Locks

Electromechanical Locks

How To Order

Series	Core Housing	Function Code	Lever Style	Trim Style	Finish	Door Hand	Options
45HM	7	DEU	14	MS	626	RH	
45HM	0** – Less Core Housing 7 – 7-pin housing; accepts all BEST cores	DEU – Electrically unlocked DEL – Electrically locked NXEU – Electrically unlocked NXEL – Electrically Locked TDEU – Electrically Unlocked TDEL – Electrically Locked LEU – Electrically unlocked LEL – Electrically locked	Levers 3 – Solid tube/return 4 – Round 12* – Solid tube/no return 14 – Curved/return 15 – Contour/angle return 16 – Curved/no return 17* – Gull wing Decorative* 50–91	MS**** – Magnetic stripe PH – Proximity HID® PHA – Proximity HID Adaptation MSA**** – Magstripe Adaptation SE – iCLASS SEA – iCLASS smartcard adaptation PSEBH – Proximity + SE + HID BLE PSEBHA – Proximity + SE + HID BLE Adaptation	626 630 690 626AM* 630AM* Satin* 606 612 613 Bright* 605 611 625 629	RH RHRB LH LHRB	P2**** – Phillips head screws Thick Door* – Specify thickness 7/8** – Flat lip strike TAC/I* – Tactile Lever Inside TAC/O* – Tactile lever Outside TAC/B* – Tactile Lever Both MWIE – Motorola 26 bit Wiegand H26B – HID 26 bit Wiegand H37B – HID 37 bit Wiegand TRK2**** – Track 2 TRK3**** – Track 3

* Indicates extra cost; see below.

** Indicates cost deduction; see below.

*** T15 Torx security screws are supplied standard.

**** Must specify track number.

Description	Function Code	Complete With Combined Core			Less Core
		Patented*	Premium	Standard	
Magnetic Stripe Reader:					
45HM - Single Keyed Latch	DEU, DEL	3,431.00	3,431.00	3,414.00	3,312.00
45HM - Non-keyed Latch	NXEU, NXEL	N/A	N/A	N/A	3,231.00
45HM - Single Keyed Deadbolt	TDEU, TDEL	3,465.00	3,465.00	3,448.00	3,346.00
45HM - Non-keyed Deadbolt	LEU, LEL	N/A	N/A	N/A	3,265.00
HID Proximity Reader:					
45HM - Single Keyed Latch	DEU, DEL	4,420.00	4,420.00	4,403.00	4,301.00
45HM - Non-keyed Latch	NXEU, NXEL	N/A	N/A	N/A	4,220.00
45HM - Single Keyed Deadbolt	TDEU, TDEL	4,427.00	4,427.00	4,410.00	4,308.00
45HM - Non-keyed Deadbolt	LEU, LEL	N/A	N/A	N/A	4,227.00
SE - HID® iCLASS® Smart Card Reader:					
45HM - Single keyed latch	DEU, DEL	4,023.00	4,023.00	4,006.00	3,904.00
45HM - Non-Keyed Latch	NXEU, NXEL	N/A	N/A	N/A	3,823.00
45HM - Single Keyed Deadbolt	TDEU, TDEL	4,059.00	4,059.00	4,042.00	3,940.00
45HM - Non-keyed Deadbolt	LEU, LEL	N/A	N/A	N/A	3,859.00
PSEBH - Proximity + SE + HID BLE					
45HM - Single keyed latch	DEU, DEL	4,657.00	4,657.00	4,640.00	4,538.00
45HM - Non-Keyed Latch	NXEU, NXEL	N/A	N/A	N/A	4,038.00
45HM - Single Keyed Deadbolt	TDEU, TDEL	4,693.00	4,693.00	4,676.00	4,574.00
45HM - Non-keyed Deadbolt	LEU, LEL	N/A	N/A	N/A	4,489.00

* Patented pricing shown is for CORMAX patented keying system. Add \$20.00 for BEST Preferred patented keying.

45HM IDH MAX™ Mortise Locks (continued)

Electromechanical Locks

Extra Cost Options*	Option Code	Add-On
Satin finishes (per lock)	606, 612, 613, 619 etc.	89.00
Bright finishes (per lock)	605, 611, 625, etc.	171.00
UltraShield antimicrobial finish	626AM, 630AM	187.00
Thick door	Specify thickness	127.00
Tactile both levers/knobs**	TAC/B	177.00
Tactile outside lever/knob**	TAC/O	94.00
Tactile inside lever/knob**	TAC/I	94.00
7/8" Lip-to-center strike	7/8 LTC	35.00
12, 17 Lever Design	12, 17	100.00
Decorative Lever Design	50-91	309.00

**Not available on #17 levers.

**Cost Deductions	Option Code	Deduct
Less cylinder option (Deduct from complete price)	0	81.00

9KM IDH MAX™ Cylindrical Locks

Electromechanical Locks

How To Order

9KM	3	7	DDEU	14	MS	STK	626	
Series	Backset	Core Housing	Function Code	Lever Style	Rose Style	Strike Package	Finish	Options
9KM	3 – 2-3/4" 4* – 3-3/4" 5* – 5"	0*** – Non-IC and LFIC competitive cylinder (less core) 6** – 6 pin non-IC cylinder 7 – 7-pin housing; accepts all BEST cores	DDEU – Electrically unlocked DDEL***** – Electrically locked	14 – Curved with return 15 – Contour with angle return 16 – Curved without return	MS***** – Magnetic stripe PH – Proximity HID® SE – HID® iCLASS® Smart Card PSEBH – Proximity + SE + HID BLE	STK – Standard S3 – ANSI S3 7/8* – Lip to center strike LS – Less Strike S3B* – ANSI (Strike w/ Plastic Box) S3B 7/8* – ANSI (Strike w/ Plastic Box)	626 690 626AM* Satin* 606 612 613 619 622 Bright* 605 611 625	LM – Lost motion P2**** – Phillips head screws 3/4* – 3/4" throw latch OB** – non-IC zero-bitted KA** – non-IC keyed alike KD** – non-IC keyed different COR**** – Non IC Corbin-Russwin MED**** – Non IC Medeco SAR**** – Non IC Sargent SCH**** – Non IC Schlage YAL**** – Non IC Yale SCHRC**** – LFIC Schlage SARRC – LFIC Sargent CORRC – LFIC Corbin YALRC – LFIC Yale AL/O* – Abrasive Lever Outside AL/I* – Abrasive Lever Inside AL/B* – Abrasive Lever Both TL/O* – Tactile Lever Outside TL/I* – Tactile Lever Inside TL/B* – Tactile Lever Both FRL* – Full radius latch MWIE – Motorola 26 bit Wiegand H26B – HID 26 bit Wiegand H37B – HID 37 bit Wiegand TRK2***** – Track 2 TRK3***** – Track 3 C-PRE+ – Terminated Quick Connect Plug

* Indicates extra cost option.
 ** Six-pin cylinder in Schlage "C" keyway included with OB, KA, KD options. Must specify "6" for core housing.
 *** Cylinder not included with COR, MED, SAR, SCH, YAL, or SCHRC options. Must specify "0" for core housing.
 **** T15 Torx security screws are supplied standard.
 ***** Must specify track number.
 + See Hinges & Door Accessories price book for Wire Harness product

Function Description	Function Code	Complete With Combined Core			Less Core	6-pin non-IC Cylinder OB, KA, KD
		Patented*	Premium	Standard		
Magnetic Stripe Reader						
9KM - Single keyed lock	DDEU, DDEL	3,277.00	3,277.00	3,260.00	3,158.00	3,238.00
HID Proximity Reader						
9KM - Single keyed lock	DDEU, DDEL	4,256.00	4,256.00	4,239.00	4,137.00	4,217.00
SE - HID® iCLASS® Smart Card Reader						
9KM - Single keyed latch	DDEU, DDEL	3,870.00	3,870.00	3,853.00	3,751.00	3,831.00
PSEBH - Proximity + SE + HID BLE						
9KM - Single keyed latch	DDEU, DDEL	4,503.00	4,503.00	4,486.00	4,384.00	4,464.00

* Patented pricing shown is for CORMAX patented keying system. Add \$20.00 for BEST Preferred patented keying.

Extra Cost Options*	Option Code	Add-On
Satin finishes (per lock)	606, 612, 613, etc.	89.00
Bright finishes (per lock)	605, 625, 629, etc.	171.00
UltraShield antimicrobial finish	626AM	187.00
3/4" throw latch	3/4	50.00
Special backsets	94KM / 95KM	34.00
Abrasive lever both sides	AL/B	66.00
Abrasive lever outside	AL/O	35.00
Abrasive lever inside	AL/I	35.00
Tactile lever both sides	TL/B	126.00
Tactile lever outside	TL/O	66.00
Tactile lever inside	TL/I	66.00
Full radius latch	FRL	34.00
7/8" Lip-to-center strike	S3 7/8	35.00
Strike with plastic box	S3B or S3B 7/8	35.00

Extra Cost Options*	Option Code	Add-On
Non-IC Corbin-Russwin (single keyed)	COR	10.00
Non-IC Medeco (single keyed)	MED	10.00
Non-IC Sargent (single keyed)	SAR	10.00
Non-IC Schlage (single keyed)	SCH	10.00
Non-IC Yale (single keyed)	YAL	10.00

NOTE: These options do not come with a cylinder. The lock is just prepped for cylinders of these other manufacturers and comes with a throw member for that manufacturer's cylinder.

Parts	Part Number	Part Price
2-3/4" deadlocking latch	8KL3	119.00
3-3/4" deadlocking latch	8KL4	148.00
5" deadlocking latch	8KL5	148.00
Standard strike package	8KS2	13.00
ANSI strike package	8KS3	38.00
Throw member 6-pin / 7-pin	B92505	4.10

Electronic Lock Software & Accessories

Electromechanical Locks

For Wi-Q Technology Wireless software, accessories and locks, see pages 74-77

Description	Part Number	Price	Offline G	Offline V	Keypad EZ	IDH Max
			G	BV	Z	M
Readers						
Magnetic card access reader - 12VDC, track 2, weatherized (no keypad), black (MR-5)	360120WBK	778.00				
Dual validation (magnetic stripe & keypad) reader - 12VDC, track 2, weatherized, black case (MR-20), with tamper contact	310120WBKOT	1,489.00				
Cards						
Magnetic Stripe Cards Non-Encoded:						
PVC (box of 500)	VPA-PVC	3,297.00	X	X		X
Electronic Lock Accessories (Continued)						
Replacement Parts:						
Shrink wrap battery pack & foam*	VPD-BATT	36.00				
Replacement battery pack	VPD-BB	64.00	X	X	X	
4 Cell Battery holder for new style 2 piece I/S escutcheon offline products	C83511	71.00	X	X	X	
8 Cell Battery holder for new style 2 piece I/S escutcheon offline products	C83522	124.00	X	X	X	
Extended life battery door cover	B62129	51.00	X	X	X	
Service Equipment:						
Offline lock programming cable	BASDCAB	300.00	X	X		
Magnetic Card Encoder	MSR20633BA	5,881.00	X	X		X
Transport USB to Serial Adapter	SES-USB	165.00	X	X		
Transport connector/adaptor (no cable, used to connect SES-USB to BASDCAB)	SES-DB9CON	41.00	X	X		
Transport cable adapter (6' Cable adapter)	SES-DB9CAB	71.00	X	X		
Power supply - 12 or 24 VDC, 2.5A output, 120 VAC input, UL	AL300ULX	968.00				
Standard driver bit	VPD-T15	51.00	X	X	X	X
McGard driver bit	VPD-HS-DRVR	63.00	X	X	X	X
McGard battery door screw (specify finish)	VPD-HS-SCRW	63.00	X	X	X	X
Cleaning cards (box of 50)	VPDCLN	285.00	X	X		X

*VPD-BATT used with legacy V Series locks only

Description	Part Number	Price	G	BV	Z	M
Aurora						
Aurora Software (Offline Locks Only)						
Aurora Basic Software	AURORA	1,717.00	X	X		
Replacement Aurora Basic Software - No Licenses	AUR-UP	518.00	X	X		
Single Additional Client License (single)	EAUR-CL1	551.00	X	X		
Five Additional Client License (5-pack)	EAUR-CL5	2,651.00	X	X		
Ten Additional Client License (10-pack)	EAUR-CL10	4,884.00	X	X		

BEST 45HQ Wireless Mortise Locks with Wi-Q™ Technology

Electromechanical Locks

How To Order

Series	Core Housing	Function Code	Lever Style	Trim Style	Finish	Door Hand	Options
45HQ	7	TV	14	MS	626	RH	
45HQ	0** – Less Core Housing 7 – 7-pin housing; accepts all BEST cores	DV – Latch w/key TV – Deadbolt w/key	Levers: 3 – Solid tube/return 12* – Solid tube/no return 14 – Curved/return 15 – Contour/angle return 16 – Curved/no return 17* – Gull wing Knobs: 4 – Round Decorative* 50–91	MS**** – Magnetic stripe DV**** – Dual validation (magstripe and keypad) DVA**** – Other cyl PH – Proximity HID® PHA – Other cyl MSA**** – Other cyl SEK – Proximity + Keypad PKPA – Proximity + Keypad adaptation SE – iCLASS SEA – iCLASS smartcard adaptation PSEBH - Proximity + SE + HID BLE PSEBHA - Proximity + SE + HID BLE Adaptation	626 630 690 626AM* 630AM* Satin* 606 612 613 Bright* 605 611 625 629	RH RHRB LH LHRB	8CE* – 8 cell battery holder assy with batteries 4SW – 4 cell shrink wrap battery P2**** – Phillips head screws Thick Door* – Specify thickness 7/8*** – Flat lip strike TAC/I* – Tactile Lever Inside TAC/O* – Tactile lever Outside TAC/B* – Tactile Lever Both TRK1**** – Track 1 TRK2**** – Track 2 TRK3**** – Track 3 WS – Windstorm Label (Florida Building Code)

NOTE: Wireless locks come with Integrated Door Hardware (IDH) as standard -Request to Exit (RQE), door position switch (DS), latch bolt monitor switch (LS) and key-override switch (KOS) on DV Function.

*Indicates extra cost option.

**Indicates cost deduction.

***T15 Torx security screws are supplied standard.

****Must specify track number.

Function Description	Function Code	Complete With Combined Core			Less Core
		Patented*	Premium	Standard	
Magnetic Stripe Reader					
45HQ– Single Keyed Latch	DV				
45HQ– Single Keyed Deadbolt	TV				
Magnetic Stripe/keypad dual validation reader					
45HQ– Single Keyed Latch	DV				
45HQ– Single Keyed Deadbolt	TV				
HID® Proximity reader					
45HQ– Single Keyed Latch	DV				
45HQ– Single Keyed Deadbolt	TV				
PKP – Proximity + Keypad Reader					
45HQ– Single Keyed Latch	DV				
45HQ– Single Keyed Deadbolt	TV				
SE – HID® iCLASS® Smart Card Reader					
45HQ– Single Keyed Latch	DV				
45HQ– Single Keyed Deadbolt	TV				
PSEBH - Proximity + SE + HID BLE					
45HQ– Single Keyed Latch	DV				
45HQ– Single Keyed Deadbolt	TV				

Contact your PACS partner for pricing.
For current WAMS customers, contact your local sales representative.

*Patented pricing shown is for CORMAX patented keying system. Add \$20.00 for Best Preferred patented keying.

BEST 45HQ Wireless Mortise Locks with Wi-Q™ Technology (cont.) Electromechanical Locks

Contact your PACS partner for pricing. For current WAMS customers, contact your local sales representative.

Extra Cost Options*	Option Code
Satin finishes (per lock)	606, 612, 613 etc.
Bright finishes (per lock)	605, 611, 625 etc.
UltraShield antimicrobial finish	626AM, 630AM
Thick door	Specify thickness
Tactile both levers/knobs**	TAC/B
Tactile outside lever/knob**	TAC/O
Tactile inside lever/knob**	TAC/I
7/8" Lip-to-center strike	7/8 LTC
12, 17 Lever Design	12, 17
Decorative Lever Design	50-91
Extended Life Battery	8CE

**Not available on #17 levers.

**Cost Deductions	Option Code
Less cylinder option (Deduct from complete price)	0

BEST 9KQ Wireless Cylindrical Locks with Wi-Q™ Technology

Electromechanical Locks

How To Order

9KQ	3	7	DV	14	MS	STK	626	
Series	Backset	Core Housing	Function Code	Lever Style	Rose Style	Strike Package	Finish	Options
9KQ	3 – 2-3/4" 4* – 3-3/4" 5* – 5"	0*** – Non-IC and LFIC competitive cylinder (less core) 6** – 6 pin non-IC cylinder 7 – 7-pin housing, accepts all BEST cores	DV – with key	14 – Curved with return 15 – Contour with angle return 16 – Curved without return 4 – Round knob	MS***** – Magnetic stripe DV***** – Dual validation (magstripe and keypad) PH – Proximity HID® PKP – Proximity + Keypad SE – iCLASS PSEBH – Proximity + SE + HID BLE	STK – Standard S3 – ANSI S3 7/8* – Lip to center strike S3B* – ANSI (Strike w/ Plastic Box) S3B 7/8* – ANSI (Strike w/ Plastic Box)	626 690 626AM* Satin* 606 612 Bright* 605 625	8CE* – 8 cell battery holder assy with batteries 4SW – 4 cell shrink wrap battery P2***** – Phillips head screws LM – Lost motion 3/4* – 3/4" throw latch OB** – non-IC zero-bitted COR*** – non IC Corbin Russwin MED*** – non IC Medeco SAR*** – non IC Sargent SCH*** – non IC Schlage YAL*** – non IC Yale SARRC**** – LFIC Sargent CORRC**** – LFIC Corbin YALRC**** – LFIC Yale SCHRC**** – LFIC Schlage AL/O* – Abrasive Lever Outside AL/I* – Abrasive Lever Inside AL/B* – Abrasive Lever Both TL/O* – Tactile Lever Outside TL/I* – Tactile Lever Inside TL/B* – Tactile Lever Both FRL – Full Radius Latch TRK1***** – Track 1 TRK2***** – Track 2 TRK3***** – Track 3 WS – Windstorm Label (Florida Building Code)

NOTE: Wireless locks come with Integrated Door Hardware (IDH) as standard – Request to Exit (RQE), Door Position Switch (DS)

* Indicates extra cost option.

** Six-pin cylinder in Schlage "C" keyway included with OB, KA, KD options. Must specify "6" for core housing.

*** Cylinder not included with COR, MED, SAR, SCH, YAL, CORRC, YALRC, SARRC, or SCHRC options. Must specify

"0" for core housing.

**** T15 Torx security screws are supplied standard.

***** Must specify track number.

Function Description	Function Code	Complete With Combined Core			Less Core	6-pin non-IC Cylinder OB, KA, KD
		Patented*	Premium	Standard		
Magnetic Stripe Reader						
9KQ - Single keyed lock	DV					
Mag Stripe Keypad Dual Validation Reader						
9KQ - Single keyed lock	DV					
HID® Proximity Reader						
9KQ - Single keyed lock	DV					
PKP- Proximity + Keypad Reader:						
9KQ - Single keyed lock	DV					
SE- HID iCLASS Smart Card Reader						
9KQ - Single keyed lock	DV					
PSEBH - Proximity + SE + HID BLE						
9KQ - Single keyed lock	DV					

Contact your PACS partner for pricing.
For current WAMS customers, contact your local sales representative.

*Patented pricing shown is for CORMAX patented keying system. Add \$20.00 for Best Preferred patented keying.

Extra Cost Options*	Option Code
Satin finishes (per lock)	606, 612, 613, etc.
Bright finishes (per lock)	605, 625, 629, etc.
UltraShield antimicrobial finish	626AM
3/4" throw latch	3/4
Special backsets	94KQ / 95KQ
Abrasive lever both sides	AL/B
Abrasive lever outside	AL/O
Abrasive lever inside	AL/I
Tactile lever both sides	TL/B
Tactile lever outside	TL/O
Tactile lever inside	TL/I
Full radius latch	FRL
7/8" Lip-to-center strike	3S 7/8
Strike with plastic box	S3B or S3B 7/8
Extended Life Battery	8CE

Extra Cost Options*	Option Code
Non-IC Corbin-Russwin (single keyed)	COR
Non-IC Medeco (single keyed)	MED
Non-IC Sargent (single keyed)	SAR
Non-IC Schlage (single keyed)	SCH
Non-IC Yale (single keyed)	YAL

NOTE: These options do not come with a cylinder. The lock is just prepped for cylinders of these other manufacturers and comes with a throw member for that manufacturer's cylinder.

Part Description	Part Number
2-3/4" deadlocking latch	8KL3
3-3/4" deadlocking latch	8KL4
5" deadlocking latch	8KL5
Standard strike package	8KS2 / 9KS2
ANSI strike package	8KS3 / 9KS3
Throw member 6-pin / 7-pin	B92505

BEST EXQ Wireless Exit Trim with Wi-Q™ Technology

How To Order

Series	Core housing	Function code	Lever style	Trim style	Finish	Door hand	Mfg	Locking type	Options
EXQ	7	EV	15	MS	626	RHR	PH2	RM	
EXQ	0 – Less Core Housing 7 – 7-pin housing; accepts all BEST cores	EV – With key** NV – Without key	14 – Curved w/ return 15 – Contour w/ angle return	MS *** – Magnetic stripe DV *** – Dual validation (magstripe and keypad) PH – Proximity HID® PKP – Proximity + Keypad SE – iCLASS PSEBH – Proximity + SE + HID BLE	626 690 626AM* Satin* 606 612 613	RHR LHR	PH2 – Precision Hardware 2000 series VD9 ** – Von Duprin 98/99 series	RM – Rim MO – Mortise RD – Surface and concealed vertical rods	SH * – Security head screws MT1 *** – Track 1 MT2 *** – Track 2 MT3 *** – Track 3

NOTE: Wireless locks come standard with door position switch (DS), connector/input to connect to a ROE switch inside exit device. (ROE switch must be purchased separately for exit device brand and model).

NOTE: Latch Switch connector is also included for use with a latch switch indicator only on Precision exit devices.

*Indicates extra cost option; see below.

**The EV function (key override) is not available on the Von Duprin Mortise type.

***Must specify track number.

Function Description	Function Code	Complete With Combined Core			Less Core
		Patented*	Premium	Standard	
Magnetic Stripe Reader					
EXQ – Exit Trim – single keyed	EV				
EXQ – Exit Trim – non keyed	NV				
Mag Stripe Keypad Dual Validation Reader					
EXQ – Exit Trim – single keyed	EV				
EXQ – Exit Trim – non keyed	NV				
HID® Proximity Reader					
EXQ – Exit Trim – single keyed	EV				
EXQ – Exit Trim – non keyed	NV				
PKP – Proximity + Keypad Reader					
EXQ – Exit Trim – single keyed	EV				
EXQ – Exit Trim – non keyed	NV				
SE – HID® iCLASS® Smart Card Reader					
EXQ – Exit Trim – single keyed	EV				
EXQ – Exit Trim – non keyed	NV				
PSEBH - Proximity + SE + HID BLE					
EXQ – Exit Trim – single keyed	EV				
EXQ – Exit Trim – non keyed	NV				

Contact your PACS partner for pricing.
For current WAMS customers, contact your local sales representative.

*Patented pricing shown is for CORMAX patented keying system. Add \$20.00 for Best Preferred patented keying.

Extra Cost Options*	Option Code
Satin finishes (per lock)	606, 612, 613
UltraShield antimicrobial finish	626AM
Security head screws	SH

Description	Part Number
Portal Gateways (WQXM- New Mercury Compatible)	
Portal Gateway for up to 64 Readers/Locks* with half wave dipole omnidirectional antenna (should only be used where PG is mounted in an open area, not in a ceiling or restricted signal area).	WQXM-PG
Portal Gateway for up to 64 Readers/Locks* with ceiling mount omnidirectional antenna.	WQXM-PG-C
Portal Gateway in a mounting enclosure, without Power Supply. This would be used with Power Over Ethernet (POE) devices (not included)	WQXM-PG-BP
Portal Gateway in a mounting enclosure, with ceiling mount omnidirectional antenna, without Power Supply. This would be used with Power Over Ethernet (POE) devices (not included)	WQXM-PG-C-BP
Portal Gateway for up to 64 Readers/Locks* with wall mount directional antenna	WQXM-PG-W
Wireless Access Controllers (WAC)	
Wireless Access Controller with half wave dipole omnidirectional antenna (should only be used where WAC is mounted in an open area, not in a ceiling or restricted signal area).	WQX-WAC
Wireless Access Controller with ceiling mount omni directional antenn	WQX-WAC-C
Wireless Access Controller in enclosure with power supply and ceiling mount omnidirectional antenna	WQX-WAC-C-B
Wireless Access Controller with wall mount directional antenna	WQX-WAC-W
Wireless Access Controller in enclosure with power supply and wall mount directional antenna	WQX-WAC-W-B
Wireless Access Controller in Nema enclosure with power supply and exterior directional antenna	WQX-WAC-D-BW
Wireless Access Controller in Nema enclosure with power supply and exterior omni-directional antenna	WQX-WAC-O-BW
Wireless Access Controller sign-on keypad	WQD-WACPAD
Power and Adapters	
Sealed battery pack	VPD-BB
Plug-in Transformer (wall-mount) with 6' of cable	WQD-12827
Power over Ethernet Power Supply/Inserter	WQD-12927-001
Power over Ethernet Active Splitter with Isolation	WQD-12928-001
Wi-Q™ Antennas & Accessories	
2.4 GHz Interior Ceiling Mount Omni-directional Antenna kit*	WQD-ACMO
2.4 GHz Interior/Exterior Wall mount directional antenna kit*	WQD-AWMD
2.4GHZ Exterior directional antenna**	WQD-AEMD
2.4GHZ Exterior omnidirectional mast mount kit**	WQD-AEMO
Exterior Antenna Grounding kit***	WQD-AGT
Surge Protection Kit	WQD-SURG
Cleaning Cards (box of 50)	VPDCLN
HID Proximity Card Enrollment Reader	RDR6081AKU

NOTE: Normal Offline software upgrade licenses apply. (Base software and 64 reader blocks)

*Antenna Kit include antenna, standard mount and 20' cable to connec to PG or WAC.

**Antenna Kit includes antenna, wall and post moutns and 20' cable to connect to PG or WAC.

***Grounding Kit includes coax grounding kit and lighting arrester.

BEST Wireless Conversion Kits with Wi-Q™ Technology

How To Order

Kit works on Offline G and V 9K and 40H Platforms
 Works on Magnetic Stripe, Dual Validation, HID® Proximity will not work on 30H Mortise Platforms.

Series Style	Description
WQCNKT-1 Cylindrical wireless upgrade kit	
WQCNKT-1 Cylindrical wireless upgrade kit	Kit to convert an Offline 9K V/G standalone lockset to a Wi-Q™ Wireless Lockset. Notes: 1) Kit includes a new 9K chassis with new motor, ROE hub and door position switch. 2) If the conversion kit will be used on a pre-2009 standalone lock with a HID Proximity Reader, it is highly recommended that a new HID Proximity reader is also purchased. The new style reader will provide better battery life than the pre-2009 HID Proximity Readers. (Part # 73132854S---- B82399 45HQ HID PROX BEZEL SUB-ASSY HID)
WQCNKT-2 Mortise DV function (without deadbolt) wireless upgrade kit with alarm functionality	Kit to convert an Offline 45H V/G standalone lockset to a Wi-Q™ Wireless Lockset. Notes: 1) Kit also contains a new 45H DV mortise case which includes ROE, door position switch, latch position switch and key-override sensor to provide for full alarm functionality. 2) If the conversion kit will be used on a pre-2009 standalone lock with a HID Proximity Reader, it is highly recommended that a new HID Proximity reader is also purchased. The new style reader will provide better battery life than the pre-2009 HID Proximity Readers. (Part # 73132854S---- B82399 45HQ HID PROX BEZEL SUB-ASSY HID)
WQCNKT-3 Mortise TV function (with deadbolt) wireless upgrade kit with alarm functionality	Kit to convert an Offline 45H V/G standalone lockset to a Wi-Q™ Wireless Lockset. Notes: 1) Kit also contains a new 45H TV mortise case which includes ROE, door position switch, deadbolt position switch, and key-override sensor to provide for full alarm functionality. 2) If the conversion kit will be used on a pre-2009 standalone lock with a HID Proximity Reader, it is highly recommended that a new HID Proximity reader is also purchased. The new style reader will provide better battery life than the pre-2009 HID Proximity Readers. (Part # 73132854S---- B82399 45HQ HID PROX BEZEL SUB-ASSY HID)

Contact your PACS partner for pricing.
 For current WAMS customers, contact your local sales representative.
Upgrade kits must be installed by a BEST Certified Technician for warranty purposes.

Electronic Lock Inside Escutcheon Conversion Kits

Electromechanical Locks

How To Order

Kit works on Keypad EZ, B.A.S.I.S. G, B.A.S.I.S. V, NT500, and Wi-Q products.
Kits do not work on IDH Max products.

Cylindrical Conversion Kits

9KEKT		DV	626	
Series	Wireless or non-wireless	Function Code	Finish	Options
9KEKT – Cylindrical conversion kit	Q – Wi-Q Wireless Blank – Non-wireless	DV – Latch w/key	626 626AM* Satin* 606 612 613 Bright* 605 625 629	8CE* – 8 cell battery holder assy with batteries 4SW – 4 cell shrink wrap battery pack P2** – Phillips head screws

*Indicates extra cost option; see below.

**T15 Torx security screws are supplied standard.

Mortise Conversion Kits

45HEKT	Q	TV	606	
Series	Wireless or non-wireless	Function Code	Finish	Options
45HEKT – Mortise conversion kit	Q – Wi-Q Wireless Blank – Non-wireless	DV – Latch w/key TV – Deadbolt w/key LV – Deadbolt w/o key NV – Latch w/o key	626 626AM* Satin* 606 612 613 Bright* 605 625 629	8CE* – 8 cell battery holder assy with batteries Thick Door* – Specify thickness P2** – Phillips head screws 4SW – 4 cell shrink wrap battery pack

*Indicates extra cost option; see below.

**T15 Torx security screws are supplied standard.

Conversion Kit	Price
9KEKT Cylindrical Conversion Kit	
Wi-Q Wireless	370.00
Non-wireless	177.00
45HEKT Mortise Conversion Kit	
Wi-Q Wireless	370.00
Non-wireless	177.00

Extra Cost Options*	Option Code	Add-On
Satin finish	606 612 613	85.00
Bright finish	605 625 629	163.00
UltraShield antimicrobial finish	626AM	178.00
Thick door	Specify thickness	121.00
Extended Life Battery	8CE	97.00

HD8000

BEST Surface Door Closers

Series	Spring Size	Body Options	Arm	Cover Options	ACC Brackets	Fastners	ACC Plates	ACC Other	Finish
HD80	16	DA	AF80P	PC	Specify	SNDTPK	Specify	Specify	689

(Bold are standard selections; or specify from available options)

HD80	16 Adjustable size 1-6 to meet barrier-free ADA requirements 56 Adjustable size 5-6 +50% power over size 6 to meet PT4C requirements	DA Delayed action AVB Advanced variable backcheck DA AVB Combination DA + AVB	AF80P, AF80J, FH, FHP, FHJ, PH, PHP, DS, DS/R, DS/RCP, DST, DST/R, LL Lead lined SDS/R, SDS/RCP, SDST, IS, ISH, SIS, SISH, ISJ, ISJH, SISJ, SISJH, SPA, SPA/R, SPA/RCP, SPAT, SPAT/R, SPAT/RCP, T, FT, JT, PT, TDE, TH, FTH, JTH, PTH, PTH, TDEH, LA	PC Plastic OPC Oversize plastic MC Metal LL Lead lined	PD PFT PHB MJ P80	SNDTPK - Self-drilling, self-tapping, thru bolts 13/4" door with machine screws TX80 - Torx security screws	BP80 DP80 CP4111 CP4040	AB80 BS BSHD NFHD FTHD BSNFHD	Painted: 600 Primed 689 Aluminum 691 Dull bronze 693 Black 695 Dark duranodic bronze 696 Gold Plated: 605 Polished brass 606 Satin brass 611 Polished bronze 612 Satin bronze 613 Satin oil-rubbed bronze 618 Polished nickel 619 Satin nickel 625 Polished chrome 626 Satin chrome
------	---	--	---	--	-------------------------------	--	----------------------------------	--	---

HD80									683.00
Spring size	Description								Price
16	Adjustable size 1-6 to meet barrier-free ADA requirements								Incl
56	Adjustable size 5-6 +50% power over size 6 to meet PT4C requirements								Incl

Complete Unit Pricing

Arm Option	Description	List Painted	List Plated
AF80P	Standard flat form arm, tri-pack	683.00	1,200.00
AF80J	Top jamb flat form arm for 4-8" reveal	679.00	1,117.00
FH	Friction hold open arm	724.00	NA
FHP	Friction hold open arm, tri-pack	734.00	NA
FHJ	Top jamb friction hold open arm for 4-8" reveal	728.00	NA
PH	Regular/Top jamb plunger hold open arm	879.00	1,265.00
PHP	Parallel/Top jamb plunger hold open arm	884.00	1,359.00
DS	Heavy duty parallel arm with stop	758.00	1,224.00
DS/R	Heavy duty parallel arm, stop with LCN PA foot	758.00	1,224.00
DS/RCP	Heavy duty parallel arm, stop with LCN PA foot & CP4040 conversion plate	843.00	1,309.00
DST	Heavy duty parallel arm with hold open and stop	823.00	1,343.00
DST/R	Heavy duty parallel arm, hold open, stop with LCN PA foot	823.00	1,343.00
DST/RCP	Heavy duty parallel arm, hold open, stop with LCN PA foot & CP4040 conversion plate	909.00	1,429.00
SDS	Heavy duty parallel arm with compression stop	966.00	1,612.00
SDS/R	Heavy duty parallel arm, compression stop with LCN PA foot	966.00	1,612.00
SDS/RCP	Heavy duty parallel arm, compression stop with LCN PA foot & CP4040 conversion plate	1,053.00	1,697.00
SDST	Heavy duty parallel arm with hold open and compression stop	1,028.00	1,682.00
IS	Heavy duty regular/top jamb arm with stop	987.00	1,443.00
ISH	Heavy duty regular/top jamb arm with hold open and stop (1-6 version only)	1,010.00	NA
SIS	Heavy duty regular/top jamb arm with compression stop (630 finish only)	1,010.00	1,639.00
SISH	Heavy duty regular/top jamb arm with hold open and compression stop (1-6 version only)	1,172.00	NA
ISJ	Heavy duty top jamb arm with stop for 3-1/2"-6-1/2" reveal	1,025.00	1,470.00
ISJH	Heavy duty top jamb arm with hold open and stop for 3-1/2"-6-1/2" reveal	1,091.00	NA
SISJ	Heavy duty top jamb arm with compression stop for 3-1/2"-6-1/2" reveal	1,135.00	1,670.00
SISJH	Heavy duty top jamb arm with hold open and compression stop for 3-1/2"-6-1/2" reveal (630 finish only)	1,203.00	NA

HD8000 (Continued)

BEST Surface Door Closers

Complete Unit Pricing

Arm Option	Description	List Painted	List Plated
SPA	Heavy duty parallel arm	711.00	1,226.00
SPA/R	Heavy duty parallel arm with LCN PA foot	711.00	1,226.00
SPA/RCP	Heavy duty parallel arm with LCN PA foot & CP4040 conversion plate	794.00	1,311.00
SPAT	Heavy duty parallel arm with thumb-turn hold open	776.00	1,224.00
SPAT/R	Heavy duty parallel arm, thumbturn hold open with LCN PA foot	776.00	1,224.00
SPAT/RCP	Heavy duty parallel arm, thumbturn hold open with LCN PA foot & CP4040 conversion plate	861.00	1,309.00
T	Track arm, pull side door mounted	728.00	1,226.00
FT	Flush track arm, push side transom mounted	728.00	1,226.00
JT	Jamb track, pull side frame mounted	728.00	1,226.00
PT	Push track arm, push side soffit mounted	728.00	1,226.00
TDE	Track arm double egress, pull side frame mounted (specify handing)	849.00	1,311.00
TH	Track arm with hold open, pull side door mounted	760.00	1,262.00
FTH	Flush track arm with hold open, push side transom mounted	760.00	1,262.00
JTH	Jamb track with hold open, pull side frame mounted	760.00	1,262.00
PTH	Push track arm with hold open, push side soffit mounted	760.00	1,262.00
TDEH	Track arm with hold open double egress, pull side frame mounted (specify handing)	882.00	1,351.00
LA	Less standard arm	deduct 111.00	deduct 261.00

Body Add-On Options

Option	Category	Description	List Add
DA	Body	Delayed action	Add 48.00
AVB	Body	Advanced variable backcheck	Add 25.00
DA AVB	Body	Combination of both DA + AVB	Add 71.00

Cover Add-On Options

Option	Category	Description	List Add
PC	Cover	Plastic cover (standard)	Incl.
OPC	Cover	Oversize plastic cover	Add 29.00
MC	Cover	Metal cover non-handed (removable mouse hole)	Add 55.00
LL	Cover	Lead lined cover non-handed (removable mouse hole)	Add 81.00

Accessory Bracket Add-On Options

Item	Category	Description	List Add Painted	List Add Plated
PD	Bracket	PA bracket for non hold open arm applications to clear surface applied stop / holder	60.00	131.00
PFT	Bracket	PA bracket for hold open and non hold open applications to mount PFT bracket flush to transom	48.00	125.00
PHB	Bracket	PA bracket for friction hold open arm. Included w/ with FHP arm	29.00	112.00
MJ	Bracket	Mortised jamb bracket for reg mount non hold open applications where normal foot can't be used	41.00	NA
P80	Bracket	Standard PA bracket for non hold open and plunger hold open applications. Included w/AF80P & PHP arms	29.00	112.00

Fastener Add-On Options

Option	Category	Description	List Add
SNTPK	Fastener	Self-drilling, self-tapping, thru bolts 1-3/4" door with machine screws	Incl.
TX80	Fastener	Torx security screws	Add 48.00

HD8000 (Continued)

BEST Surface Door Closers

Accessory Plate Add-On Options

Item	Category	Description		List Add
BP80	Back plate	Backplate typically for TJ mount closer body w/ restricted ceiling clearance	Add	87.00
DP80	Drop plate	Drop plate for PA mounted closer body to doors' top rail or TJ w/ restricted ceiling clearance	Add	87.00
CP4III	Conversion Plate	Conversion plate to retrofit LCN4III	Add	87.00
CP4040	Conversion plate	Conversion plate to retrofit LCN4040	Add	87.00

Accessory OTHER Add-On Options

Item	Category	Description	List Add Painted	List Add Plated
AB80	Bracket	Angle bracket for PA and TJ mount where field conditions require to mount closer body to bracket	87.00	NA
BS	Spacer	Blade stop spacer for PA mounted applications. Spacer fits against frame's stop	41.00	NA
BSHD	Spacer	Blade stop spacer for HD PA mounted applications. Spacer fits against frame's stop	42.00	NA
NFHD	Bracket	Angled narrow frame bracket to give support to HD PA arms. Used in conjunction with BSHD	41.00	118.00
FTHD	Bracket	Angled flush transom bracket for heavy duty PA applications where normal soffit conditions don't exist	64.00	NA
BSNFHD	Kit	BSHD + NFHD kit	83.00	NA

Custom/Designer Color Add-On Options

Option	Category	Description		List Add
RAL Custom Color	Finish	Custom painted finish selected from RAL color pallet book (Per order; per color set up, net; no discount applied)	Net	157.00
RAL Custom Color	Finish	Per closer	Add	55.00
Designer Color	Finish	Designer painted finish matched to supplied samples. (3x 2"x 3" samples required) (Per order; per color set up, net; no discount applied)	Net	357.00
Designer Color	Finish	Per closer	Add	55.00

Body Package Less Arm

Item	Description	List Painted	List Plated
HD8016 LA	Adj 1-6 closer w/ PC cover SNDTPK	540.00	864.00
HD8056 LA	Adj 5-6 +50% power closer w/ PC cover SNDTPK	540.00	864.00
HD8016 DA LA	Adj 1-6 delayed action closer w/ PC cover SNDTPK	587.00	911.00
HD8056 DA LA	Adj 5-6 +50% power delayed action closer w/ PC cover SNDTPK	587.00	911.00
HD8016 AVB LA	Adj 1-6 advanced variable backcheck closer w/ PC cover SNDTPK	564.00	888.00
HD8056 AVB LA	Adj 5-6 +50% power advanced variable backcheck closer w/ PC cover SNDTPK	564.00	888.00
HD8016 DA AVB LA	Adj 1-6 delayed action, advanced variable backcheck closer w/ PC cover SNDTPK	610.00	934.00
HD8056 DA AVB LA	Adj 5-6 +50% power delayed action, advanced variable backcheck closer w/ PC cover SNDTPK	610.00	934.00

Accessories

Item	Description	List Add Painted	List Add Plated
AF80P	Standard flat form arm, tri-pack	146.00	338.00
AF80J	Top jamb flat form arm for 4-8" reveal	139.00	252.00
FH	Friction hold open arm	172.00	NA
FHP	Friction hold open arm, tri-pack	184.00	NA
FHJ	Top jamb friction hold open arm for 4-8" reveal	178.00	NA
PH	Regular/Top jamb plunger hold open arm	272.00	484.00
PHP	Parallel/Top jamb plunger hold open arm	277.00	590.00
DS	Heavy duty parallel arm with stop	203.00	383.00
DS/R	Heavy duty parallel arm, stop with LCN PA foot	203.00	383.00
DS/RCP	Heavy duty parallel arm, stop with LCN PA foot & CP4040 conversion plate	289.00	468.00
DST	Heavy duty parallel arm with hold open and stop	261.00	438.00
DST/R	Heavy duty parallel arm, stop with LCN PA foot	261.00	438.00

Accessories

Item	Description	List Add Painted	List Add Plated
DST/RCP	Heavy duty parallel arm, stop with LCN PA foot & CP4040 conversion plate	344.00	522.00
SDS	Heavy duty parallel arm with compression stop	371.00	517.00
SDS/R	Heavy duty parallel arm, hold open, compression stop with LCN PA foot	371.00	517.00
SDS/RCP	Heavy duty parallel arm, hold open, compression stop with LCN PA foot & CP4040 conversion plate	458.00	603.00
SDST	Heavy duty parallel arm with hold open and compression stop	431.00	574.00
IS	Heavy duty regular/top jamb arm with stop	364.00	584.00
ISH	Heavy duty regular/top jamb arm with hold open and stop	417.00	NA
SIS	Heavy duty regular/top jamb arm with compression stop	454.00	714.00
SISH	Heavy duty regular/top jamb arm with hold open and compression stop	512.00	NA
ISJ	Heavy duty top jamb arm with stop for 3-1/2"-6-1/2" reveal	393.00	608.00
ISJH	Heavy duty top jamb arm with hold open and stop for 3-1/2"-6-1/2" reveal	447.00	NA
SISJ	Heavy duty top jamb arm with compression stop for 3-1/2"-6-1/2" reveal	483.00	585.00
SISJH	Heavy duty top jamb arm with hold open and compression stop for 3-1/2"-6-1/2" reveal	539.00	NA
SPA	Heavy duty parallel arm	162.00	340.00
SPA/R	Heavy duty parallel arm with LCN PA foot	162.00	340.00
SPA/RCP	Heavy duty parallel arm with LCN PA foot & CP4040 conversion plate	248.00	426.00
SPAT	Heavy duty parallel arm with thumb-turn hold open	220.00	397.00
SPAT/R	Heavy duty parallel arm, thumbturn hold open with LCN PA foot	220.00	397.00
SPAT/RCP	Heavy duty parallel arm, thumbturn hold open with LCN PA foot & CP4040 conversion plate	305.00	482.00
T	Track arm, pull side door mounted	178.00	414.00
FT	Flush track arm, push side transom mounted	178.00	414.00
JT	Jamb track, pull side frame mounted	178.00	414.00
PT	Push track arm, push side soffit mounted	178.00	414.00
TDE	Track arm double egress, pull side frame mounted	252.00	NA
TH	Track arm with hold open, pull side door mounted	208.00	444.00
FTH	Flush track arm with hold open, push side transom mounted	208.00	444.00
JTH	Jamb track with hold open, pull side frame mounted	208.00	444.00
PTH	Push track arm with hold open, push side soffit mounted	208.00	444.00
TDEH	Track arm with hold open double egress, pull side frame mounted	280.00	NA
M8X30	Arm screw only (arm type determines screw)	52.00	NA
M8X16	Arm screw only (arm type determines screw)	52.00	NA
SNDTPK80	Standard self-drilling, self tapping and through bolts (replacement pack)	48.00	NA
PC80	Cover Option standard full size plastic cover	35.00	NA
OPC80	Cover Option over-sized plastic cover	41.00	NA
MC80	Cover Option non handed metal cover	60.00	183.00
OMC80	Over-sized non handed metal cover	74.00	195.00
LL80	Cover Option non handed lead lined cover	175.00	311.00

Series	Spring Size	Body Options	Arm	Cover Options	ACC Brackets	Fasteners	ACC Plates	ACC Other	Finish
HD70	16	DA	ARP	FPC	Specify	SNDTPK	Specify	Specify	689

(Bold are standard selections; or specify from available options)

HD70	16 Adjustable size 1-6 to meet barrier-free ADA requirements	DA Delayed action	ARP, ARJ, A80P, FH, FHP, FHJ, PH, PHP, DS, DST, SDS, SDST, IS, ISH, SIS, SISH, ISJ, ISJH, SISJ, SISJH, SPA, SPA/R, SPA/RCP, SPAT, T, FT, JT, PT, TDE, TH, FTH, JTH, PTH, PTH, TDEH, LA	FPC Full Plactic SPC Sim Plastic MC Metal LL Lead Lined	PD PFT PHB MJ P70	SNDTPK - Self-drilling, self-tapping, thru bolts 1 3/4" door with machine screws TX70 - Torx security screws	BP70 BP70FC BP70T BP70TFC BP70FT-FC DP70 DP70FC	AB70 BS BSHD NFHD FTHD BSNFHD	Painted: 600 Primed 689 Aluminum 691 Dull bronze 693 Black 695 Dark duranodic bronze 696 Gold Plated: 605 Polished brass 606 Satin brass 611 Polished bronze 612 Satin bronze 613 Satin oil-rubbed bronze 618 Polished nickel 619 Satin nickel 625 Polished chrome 626 Satin chrome 630 Satin stainless
------	--	-------------------	--	---	-------------------	---	---	-------------------------------	--

HD70 539.00

Spring size	Description	Price
16	Adjustable size 1-6 to meet barrier-free ADA requirements	Incl

Complete Unit Pricing

Arm Option	Description	List Painted	List Plated
ARP	Standard arm	539.00	1,030.00
ARJ	Top jamb round form arm for 4-8" reveal	524.00	940.00
AO8P	Secured round form arm, tri-pack	539.00	NA
FH	Friction hold open arm	598.00	NA
FHP	Friction hold open arm, tri-pack	728.00	NA
FHJ	Top jamb friction hold open arm for 4-8" reveal	578.00	NA
PH	Regular/Top jamb plunger hold open arm	728.00	1,166.00
PHP	Parallel/Top jamb plunger hold open arm	734.00	1,246.00
DS	Heavy duty parallel arm with stop	652.00	1,153.00
DST	Heavy duty parallel arm with hold open and stop	729.00	1,472.00
SDS	Heavy duty parallel arm with compression stop	853.00	1,507.00
SDST	Heavy duty parallel arm with hold open and compression stop	927.00	1,581.00
IS	Heavy duty regular/top jamb arm with stop	843.00	1,306.00
ISH	Heavy duty regular/top jamb arm with hold open and stop	917.00	NA
SIS	Heavy duty regular/top jamb arm with compression stop (630 finish only)	961.00	1,530.00
SISH	Heavy duty regular/top jamb arm with hold open and compression stop	1,027.00	NA
ISJ	Heavy duty top jamb arm with stop for 3-1/2"-6-1/2" reveal	878.00	1,354.00
ISJH	Heavy duty top jamb arm with hold open and stop for 3-1/2"-6-1/2" reveal	950.00	NA
SISJ	Heavy duty top jamb arm with compression stop for 3-1/2"-6-1/2" reveal (630 finish only)	993.00	1,567.00
SISJH	Heavy duty top jamb arm with hold open and compression stop for 3-1/2"-6-1/2" reveal	1,065.00	NA
SPA	Heavy duty parallel arm	587.00	1,103.00
SPAT	Heavy duty parallel arm with thumb-turn hold open	658.00	1,178.00
T	Track arm, pull side door mounted	606.00	1,086.00
FT	Flush track arm, push side transom mounted	606.00	1,086.00
JT	Jamb track, pull side frame mounted	606.00	1,086.00
PT	Push track arm, push side soffit mounted	606.00	1,086.00
TDE	Track arm double egress, pull side frame mounted (specify handing)	696.00	1,181.00

Complete Unit Pricing

Arm Option	Description	List Painted	List Plated
TH	Track arm with hold open, pull side door mounted	641.00	1,126.00
FTH	Flush track arm with hold open, push side transom mounted	641.00	1,126.00
JTH	Jamb track with hold open, pull side frame mounted	641.00	1,126.00
PTH	Push track arm with hold open, push side soffit mounted	641.00	1,126.00
TDEH	Track arm with hold open double egress, pull side frame mounted (specify handing)	731.00	1,221.00
LA	Less standard arm	deduct 91.00	deduct 239.00

Body Add-On Options

Option	Category	Description	List Add
DA	Body	Delayed action	Add 51.00

Cover Add-On Options

Option	Category	Description	List Add
FPC	Cover	Full plastic cover (standard)	Incl.
SPC	Cover	Slim plastic cover	Add 32.00
MC	Cover	Metal cover (specify hand)	Add 59.00
LL	Cover	Lead lined cover (specify hand)	Add 86.00

Accessory Bracket Add-On Options

Item	Category	Description	List Add Painted	List Add Plated
PD	Bracket	PA bracket for non hold open arm applications to clear surface applied stop / holder	66.00	145.00
PFT	Bracket	PA bracket for hold open and non hold open applications to mount PFT bracket flush to transom	52.00	135.00
PHB	Bracket	PA bracket for friction hold open arm. Included w/ with FHP arm	32.00	125.00
MJ	Bracket	Mortised jamb bracket for reg mount non hold open applications where normal foot can't be used	45.00	NA
P70	Bracket	Standard PA bracket for non hold open and plunger hold open applications. Included w/ ARP, A08P & PHP arms	29.00	115.00

Fastener Add-On Options

Option	Category	Description	List Add
SNDTPK	Fastener	Self-drilling, self-tapping, thru bolts 1-3/4" door with machine screws	Incl.
TX70	Fastener	Torx security screws	Add 51.00

Accessory Plate Add-On Options

Item	Category	Description	List Add Painted	List Add Plated
BP70	Backplate	Backplate typically for TJ mount closer body w/ restricted ceiling clearance	97.00	NA
BP70FC	Backplate	Backplate typically for TJ mount closer body w/ restricted ceiling clearance for plate for use w/ FPC cover	97.00	NA
BP70T	Backplate	Backplate for use 2" TJ mount closer with track arm application - pull side	97.00	NA
BP70TFC	Backplate	Backplate for use 2" TJ mount closer with track arm application - pull side - for use w/ FPC cover	97.00	NA
BP70FTFC	Backplate	Backplate for use TJ mount closer with track arm application - pull side - for use w/ FPC cover. Holes in plate to avoid rabbet on door	97.00	NA
DP70	Drop plate	Drop plate for PA mounted closer body to doors' top rail or TJ w/ restricted ceiling clearance	97.00	NA
DP70FC	Drop plate	Drop plate for PA mounted closer body to doors' top rail or TJ w/ restricted ceiling clearance for use w/ FPC cover	97.00	NA

HD7000 (Continued)

BEST Surface Door Closers

Accessory OTHER Add-On Options

Item	Category	Description	List Add Painted	List Add Plated
AB70	Bracket	Angle bracket for PA and TJ mount where field conditions require to mount closer body to bracket	97.00	NA
BS	Bracket	Blade stop spacer for PA mounted applications. Spacer fits against frame's stop	45.00	NA
BSHD	Spacer	Blade stop spacer for HD PA mounted applications. Spacer fits against frame's stop	48.00	NA
NFHD	Bracket	Angled narrow frame bracket to give support to HD PA arms. Used in conjunction with BSHD	45.00	130.00
FTHD	Bracket	Angled flush transom bracket for heavy duty PA applications where normal soffit conditions don't exist	69.00	NA
BSNFHD	Kit	BSHD + NFHD kit	92.00	NA

Custom/Designer Color Add-On Options

Option	Category	Description	List Add
RAL Custom Color	Finish	Custom painted finish selected from RAL color pallet book. [Per order; per color set up; net; no discount applied]	Net 169.00
RAL Custom Color	Finish	Per closer	Add 59.00
Designer Color	Finish	Designer painted finish color matched to supplied samples. [3x 2"x 3" samples required] [Per order; per color set up; net; no discount applied]	Net 382.00
Designer Color	Finish	Per closer	Add 59.00

Body Package Less Arm

Item	Description	List Painted	List Plated
HD7016LA	Adj 1-6 closer w/ FPC cover SNDTPK	411.00	694.00
HD7016DA LA	Adj 1-6 delayed action closer w/ FPC cover SNDTPK	460.00	743.00

Accessories

Item	Description	List Add Painted	List Add Plated
ARP	Standard round form arm, tri-pack	131.00	339.00
ARJ	Top jamb round form arm for 4-8" reveal	125.00	253.00
A08P	Secured round form arm, tri-pack	137.00	NA
FH	Friction hold open arm	188.00	NA
FHP	Friction hold open arm, tri-pack	202.00	NA
FHJ	Top jamb friction hold open arm for 4-8" reveal	197.00	NA
PH	Regular/Top jamb plunger hold open arm	298.00	530.00
PHP	Parallel/Top jamb plunger hold open arm	305.00	647.00
DS	Heavy duty parallel arm with stop	222.00	420.00
DST	Heavy duty parallel arm with hold open and stop	287.00	479.00
SDS	Heavy duty parallel arm with compression stop	408.00	566.00
SDST	Heavy duty parallel arm with hold open and compression stop	473.00	629.00
IS	Heavy duty regular/top jamb arm with stop	399.00	640.00
ISH	Heavy duty regular/top jamb arm with hold open and stop	458.00	NA
SIS	Heavy duty regular/top jamb arm with compression stop	497.00	782.00
SISH	Heavy duty regular/top jamb arm with hold open and compression stop	561.00	NA
ISJ	Heavy duty top jamb arm with stop for 3-1/2"-6-1/2" reveal	430.00	666.00
ISJH	Heavy duty top jamb arm with hold open and stop for 3-1/2"-6-1/2" reveal	491.00	NA
SISJ	Heavy duty top jamb arm with compression stop for 3-1/2"-6-1/2" reveal	529.00	641.00
SISJH	Heavy duty top jamb arm with hold open and compression stop for 3-1/2"-6-1/2" reveal	591.00	NA
SPA	Heavy duty parallel arm	179.00	373.00
SPAT	Heavy duty parallel arm with thumb-turn hold open	240.00	434.00
EMF	Electric hold open track arm	729.00	NA
T	Track arm, pull side door mounted	197.00	455.00

Accessories

Item	Description	List Add Painted	List Add Plated
FT	Flush track arm, push side transom mounted	197.00	455.00
JT	Jamb track, pull side frame mounted	197.00	455.00
PT	Push track arm, push side soffit mounted	197.00	455.00
TDE	Track arm double egress, pull side frame mounted	276.00	NA
TH	Track arm with hold open, pull side door mounted	230.00	486.00
FTH	Flush track arm with hold open, push side transom mounted	230.00	486.00
JTH	Jamb track with hold open, pull side frame mounted	230.00	486.00
PTH	Push track arm with hold open, push side soffit mounted	230.00	486.00
TDEH	Track arm with hold open double egress, pull side frame mounted	307.00	NA
M8X30	Arm screw only (arm type determines screw)	5.70	NA
M8X16	Arm screw only (arm type determines screw)	5.70	NA
SNDTPK70	Standard self-drilling, self tapping and through bolts (replacement pack)	52.00	NA
MC70L or MC70R	Handed metal cover	60.00	201.00
LL70L / LL70R	Handed lead lined cover	189.00	339.00

SL6000

BEST Surface Door Closers

Series	Spring Size	Options	Arm	Cover Options	ACC Brackets	Fastners	ACC Plates	ACC Other	Finish
SL60	14	DA	ARP	SPC	Specify	SNDTPK	Specify	Specify	689

(Bold are standard selections; or specify from available options)

SL60	16 Adjustable size 1-6 to meet barrier-free ADA requirements 36 Adjustable size 3 -6	DA Delayed action	ARP, ARJ, A80P, FH, FHP, FHJ, PH, PHP, DS, DST, SDS, SDST, IS, ISH, SIS, SISH, ISJ, ISJH, SISJ, SISJH, SPA, SPA/R, SPA/RCP, SPAT, T, FT, JT, PT, TDE, TH, FTH, JTH, PTH, PTH, TDEH, LA	SPC Sim Plastic	PD PFT PHB MJ P60	SNDTPK - Self-drilling, self-tapping, thru bolts 1 3/4" door with machine screws TX70 - Torx security screws	BP60 BP60T DP60 SL640C	AB60 BS BSHD NFHD FTHD BSNFHD	Painted 600 Primed 689 Aluminum 691 Dull bronze 693 Black 695 Dark duranodic bronze 696 Gold
------	---	-------------------	--	-----------------	-------------------------------	---	---------------------------------	--	--

SL60 359.00

Spring size	Description	Price
14	Adjustable size 1-4 to meet barrier-free ADA requirements	Incl.
36	Adjustable size 3-6	Incl.

Complete Unit Pricing

Item	Description	List Painted
ARP	Standard arm	359.00
ARJ	Top jamb-round form arm for 4 -8" reveal	352.00
A08P	Secured round form arm, tri-pack	360.00
FH	Friction hold open arm	426.00
FHP	Friction hold open arm, tri-pack	448.00
FHJ	Top jamb friction hold open arm for 4 -8" reveal	431.00
DS	Heavy duty parallel arm with stop	464.00
DST	Heavy duty parallel arm with hold open and stop	532.00
SDS	Heavy duty parallel arm with compression stop	675.00
SDST	Heavy duty parallel arm with hold open and compression stop	741.00
IS	Heavy duty regular/top jamb arm with stop	664.00
ISH	Heavy duty regular/top jamb arm with hold open and stop	731.00
SIS	Heavy duty regular/top jamb arm with compression stop	774.00
SISH	Heavy duty regular/top jamb arm with hold open and compression stop	843.00
ISJ	Heavy duty top jamb arm with stop for 3-1/2"-6-1/2" reveal	695.00
ISJH	Heavy duty top jamb arm with hold open and stop for 3-1/2"-6-1/2" reveal	770.00
SISJ	Heavy duty top jamb arm with compression stop for 3-1/2"-6-1/2" reveal	808.00
SISJH	Heavy duty top jamb arm with hold open and compression stop for 3-1/2"-6-1/2" reveal	881.00
SPA	Heavy duty parallel arm	412.00
SPAT	Heavy duty parallel arm with thumb-turn hold open	481.00
T	Track arm, pull side door mounted	431.00
FT	Flush track arm, push side transom mounted	431.00
JT	Jamb track, pull side frame mounted	431.00
PT	Push track arm, push side soffit mounted	431.00
TDE	Track arm double egress, pull side frame mounted (specify handing; size 3-6 only)	494.00
TH	Track arm with hold open, pull side door mounted	470.00
FTH	Flush track arm with hold open, push side transom mounted	470.00
JTH	Jamb track with hold open, pull side frame mounted	470.00
PTH	Push track arm with hold open, push side soffit mounted	470.00
TDEH	Track arm with hold open double egress, pull side frame mounted (specify handing; size 3-6 only)	528.00
LA	Less standard arm	Deduct 91.00

Body Add-On Options

Option	Category	Description	List Add
DA	Body	Delayed action	51.00

Cover Add-On Options

Option	Category	Description	List Add
SPC	Cover	Slim plastic cover	32.00

Accessory Bracket Add-On Options

Item	Category	Description	List Add Painted
PD	Bracket	PA bracket for non hold open arm applications to clear surface applied stop / holder	66.00
PFT	Bracket	PA bracket for hold open and non hold open applications to mount PFT bracket flush to transom	52.00
PHB	Bracket	PA bracket for friction hold open arm. Included w/ with FHP arm	32.00
MJ	Bracket	Mortised jamb bracket for reg mount non hold open applications where normal foot can't be used	45.00
P70	Bracket	Standard PA bracket for non hold open and plunger hold open applications. Included w/ ARP, AO8P & PHP arms	29.00

Fastener Add-On Options

Option	Category	Description	List Add
SNDTPK	Fastener	Self-drilling, self-tapping, thru bolts 1-3/4" door with machine screws	Incl.
TX70	Fastener	Torx security screws	51.00

Accessory Plate Add-On Options

Item	Category	Description	List Add Painted
BP60	Backplate	Backplate typically for TJ mount closer body w/ restricted ceiling clearance	97.00
BP60T	Backplate	Backplate for use 2" TJ mount closer with track arm application - pull side	97.00
DP60	Drop plate	Drop plate for PA mounted closer body to doors' top rail or TJ w/ restricted ceiling clearance	97.00

Accessory OTHER Add-On Options

Item	Category	Description	List Add Painted
AB60	Bracket	Angle bracket for PA and TJ mount where field conditions require to mount closer body to bracket	97.00
BS	Spacer	Blade stop spacer for PA mounted applications. Spacer fits against frame's stop	45.00
BSHD	Spacer	Blade stop spacer for HD PA mounted applications. Spacer fits against frame's stop	48.00
NFHD	Bracket	Angled narrow frame bracket to give support to HD PA arms. Used in conjunction with BSHD	45.00
FTHD	Bracket	Angled flush transom bracket for heavy duty PA applications where normal soffit conditions don't exist	69.00
BSNFHD	Kit	BSHD + NFHD kit	92.00

Custom/Designer Color Add-On Options

Option	Category	Description	List Add
RAL Custom Color	Finish	Custom painted finish selected from RAL color pallet book. (Per order; per color set up; net; no discount applied)	Net 169.00
RAL Custom Color	Finish	Per closer	Add 59.00
Designer Color	Finish	Designer painted finish color matched to supplied samples. (3x 2"x 3" samples required) (Per order; per color set up; net; no discount applied)	Net 382.00
Designer Color	Finish	Per closer	Add 59.00

SL6000 (Continued)

BEST Surface Door Closers

Body Package Less Arm

Item	Description	List Painted
SL6014LA	Adj 1-4 closer w/ SNDTPK	231.00
SL6036LA	Adj 3-6 closer w/ SNDTPK	231.00
SL6014DA LA	Adj 1-4 delayed action closer w/ SNDTPK	283.00
SL6036DA LA	Adj 3-6 delayed action closer w/ SNDTPK	283.00

Accessories

Item	Description	List Painted
ARP	Standard round form arm, tri-pack	131.00
ARJ	Top jamb round form arm for 4-8" reveal	125.00
AQBP	Secured round form arm, tri-pack	137.00
FH	Friction hold open arm	188.00
FHP	Friction hold open arm, tri-pack	202.00
FHJ	Top jamb friction hold open arm for 4-8" reveal	197.00
DS	Heavy duty parallel arm with stop	222.00
DST	Heavy duty parallel arm with hold open and stop	287.00
SDS	Heavy duty parallel arm with compression stop	408.00
SDST	Heavy duty parallel arm with hold open and compression stop	473.00
IS	Heavy duty regular/top jamb arm with stop	399.00
ISH	Heavy duty regular/top jamb arm with hold open and stop	458.00
SIS	Heavy duty regular/top jamb arm with compression stop	497.00
SISH	Heavy duty regular/top jamb arm with hold open and compression stop	561.00
ISJ	Heavy duty top jamb arm with stop for 3-1/2"-6-1/2" reveal	430.00
ISJH	Heavy duty top jamb arm with hold open and stop for 3-1/2"-6-1/2" reveal	491.00
SISJ	Heavy duty top jamb arm with compression stop for 3-1/2"-6-1/2" reveal	529.00
SISJH	Heavy duty top jamb arm with hold open and compression stop for 3-1/2"-6-1/2" reveal	591.00
SPA	Heavy duty parallel arm	179.00
SPAT	Heavy duty parallel arm with thumb-turn hold open	240.00
T	Track arm, pull side door mounted	197.00
FT	Flush track arm, push side transom mounted	197.00
JT	Jamb track, pull side frame mounted	197.00
PT	Push track arm, push side soffit mounted	197.00
TDE	Track arm double egress, pull side frame mounted	276.00
TH	Track arm with hold open, pull side door mounted	230.00
FTH	Flush track arm with hold open, push side transom mounted	230.00
JTH	Jamb track with hold open, pull side frame mounted	230.00
PTH	Push track arm with hold open, push side soffit mounted	230.00
TDEH	Track arm with hold open double egress, pull side frame mounted	307.00
SL640C	Drop plate for PA mounted closer body to doors' top rail or TJ w/ restricted ceiling clearance for use w/ FPC cover	12.00
M8X30	Arm screw only (arm type determines screw)	5.70
M8X16	Arm screw only (arm type determines screw)	5.70
SNDTPK70	Standard self-drilling, self tapping and through bolts (replacement pack)	52.00

ED50LE

Low Energy Operators



7266003



7266004



7266005



7266006

The ED50LE low energy swing door operator is easy to install and is the perfect solution for touch-free access applications, offering a true manual door closer experience.

This medium-duty swing door operator can automate new or existing manual swing doors with a wave plate (RCI 946T, 950T Series; 910TC Series or 912 Series), or other "knowing act" device. The ED50LE combines advanced automatic power assist, minimal push forces (as low as ANSI size 1) and reliable closing. Outswing or inswing doors can be adapted for touch-free access with push or pull arms suited to a wide variety of door usage options.

ED50LE

Item	Description	Finish	List Price
7266003	34" Single Operator, PULL ARM	CL - Clear anodized	4,069.00
7266004	34" Single Operator, PULL ARM	DB - Dark bronze anodized	4,069.00
7266005	34" Single Operator, PUSH ARM	CL - Clear anodized	4,069.00
7266006	34" Single Operator, PUSH ARM	DB - Dark bronze anodized	4,069.00

ED100LE



7265853



7265854



7265855



7265856

The ED100LE low energy swing door operator is the perfect solution for touch free access applications, a versatile operator ideal for ADA-compliant applications.

This medium or heavy-duty swing door operator can automate new or existing manual swing doors with a wave plate (RCI 946T, 950T Series; 910TC Series or 912 Series) or other "knowing act" device. The ED100LE combines advanced power assist, reliable closing, and special firmware capabilities to help manage the combination of wind and building pressure. With a multitude of adjustable features, you have the flexibility to fine tune the operator to meet opening requirements.

ED100LE

Item	Description	Finish	List Price
7265853	34" Single Operator, PULL ARM	CL - Clear anodized	7,100.00
7265854	34" Single Operator, PULL ARM	DB - Dark bronze anodized	7,100.00
7265855	34" Single Operator, PUSH ARM	CL - Clear anodized	7,100.00
7265856	34" Single Operator, PUSH ARM	DB - Dark bronze anodized	7,100.00

D-4990 Series

Low Energy Operators



D-4990



D-4990T

Part Number	Description	Price
D-4990	PUSH Side Mount (includes arm assembly)	6,303.00
D-4990T	PULL Side Mount (includes arm assembly)	6,571.00

Arm Assemblies

Part Number	Description	Price
A45-501L	Used with D-4990 only	167.00
A45-507T	Used with D-4990T only	270.00

Low Energy Operator Weight

Part Number	Weight
D-4990	40lbs
D-4990T	

D-4990 Accessories



CL2216



CL2223



CL4163



CL2388

Part Number	Description	Price
PS490	Optional Power Supply 24VDC @ 0.5A	101.00

6" Round Stainless Steel Plate

CL2216	Handicap logo and Push-to-Open text	362.00
CL2220	6" round surface mount box	156.00
CL2223	6" round weather ring	34.00

4 3/4" Square Stainless Steel Plate

CL2102	Handicap logo and Push-to-Open text	340.00
CL2236	Square surface mount box	156.00

4 1/2" Square Stainless Steel Plate

CL4163	Handicap logo and Push-to-Open text	327.00
CL4638	Square surface mount box	156.00

Jamb Stainless Steel Plate

CL2055	Handicap logo and Push-to-Open text	268.00
CL2245	Surface mount box	52.00

Dual Push Plate "Vestibule Plate"

CL2388	Vestibule plate with text, logo and arrows	521.00
--------	--	--------

D-4990 Series (Continued)

Low Energy Operators



CL2025



CL4490



CL4485



CL2247

Part Number	Description	Price
Touchless Push Plates		
CL2025	Touchless push plate fits single/double gang box	540.00
Radio Control 433 Transmitters / 433 Receiver		
CL4490	Digital transmitter 433MHz w/flag conn 9v battery (1 button)	355.00
CL4485	433 MHz digital receiver	388.00
Push Plate Posts		
CL2248	Silver - mounting post for stainless steel push plates*	727.00
CL2247	Black - mounting post for stainless steel push plates*	702.00
CL2249	Bronze - mounting post for stainless steel push plates*	727.00
*For use with 4 1/2" square plates part # CL4163		
Push Plate Packages		
CL4976	Includes (2) CL4163 Text & Logo plates, (2) CL4638 boxes, (2) CL4490 (9volt) Transmitters, (1) CL4485 Receiver	1,977.00
CL4977	Includes (2) CL4163 Text & Logo plates, (2) CL4638 boxes, HARD WIRED SOLUTION ONLY	934.00
CL4980	Includes (2) CL2102 Text & Logo plates, (2) CL2236 boxes, (2) CL4490 (9 volt) Transmitters, (1) CL4485 Receiver	1,975.00
CL4981	Includes (2) CL2102 Text & Logo plates, (2) CL2236 boxes, HARD WIRED SOLUTION ONLY	934.00
CL4990	Includes (2) CL2216 Text & Logo Plates, (2) CL220 boxes, (2) CL4490 (9 volt) Transmitters, (1) CL4485 Receiver	2,017.00
CL4991	Includes (2) CL2216 Text & Logo Plates, (2) CL220 boxes, HARD WIRED SOLUTION ONLY	692.00

How To Order – EHD9000 -- AVB body; PC90 Cover and SNDTPK90 Fasteners ship automatically unless other options are specified in nomenclature:

EHD90 16		AF90P		Specify		Specify		Specify		689	
Model	Spring	Body Option	Arm	Accessory Brackets	Cover Options	Fasteners	Accessory Plates	Other Accessories	Available Finish		
EHD90	16 Adjustable size 1-6 +50% power over size 6 to meet PT4C and barrier-free ADA requirements	DA AVB - Combination DA + AVB Standard select is AVB (Advanced variable backcheck)	AF90P, AF90J, AF90, FH90, FHP90, FHJ90, PH90, PHP90, DS90, DST90, SDS90, SDST90, IS90, ISH90, SIS90, SISH90, ISJ90, ISJH90, SISJ90, SISJH90, SPA90, SPAT90, T90, FT90, JT90, PT90, TDE90L, TDE90R, TH90, FTH90, JTH90, PTH90, TDEH90L, TDEH90R, LA	PFT90, PD90, PHB90, MJ90, P90	MC90 - Metal lined LL90 - Lead lined Standard select is PC90 (plastic)	TX90 - Torx security screws Standard select is SNDTPK90 (Self-drilling & tapping, thru bolts 1-3/4" door with machine screws)	BP90, DB90	AB90, NFHD90, FTHD90, BSHD90, BSNFHD90	Painted 600 Primed 689 Aluminum 691 Dull bronze 693 Black 695 Dark duranodic bronze 696 Gold	Plated: 605 Polished brass 606 Satin brass 611 Polished bronze 612 Satin bronze 613 Oxidized satin oil-rubbed bronze 618 Polished nickel 619 Satin nickel 625 Polished chrome 626 Satin chrome 630 Satin stainless	
EHD90										697.00	

Spring size	Description	Price
16	Adjustable size 1-6 +50% power over size 6 to meet PT4C and barrier-free ADA requirements	Incl

Complete Unit Pricing

Arm Option	Description	List Painted	List Plated
AF90P	Standard flat form arm, tri-pack	697.00	1244.00
AF90J	Top jamb flat form arm for 4-8" reveal	693.00	1240.00
AF90	Regular or top jamb flat form arm for to 4" reveals	691.00	1238.00
FH90	Friction hold open arm	748.00	NA
FHP90	Friction hold open arm, tri-pack	759.00	1355.00
FHJ90	Top jamb friction hold open arm for 4-8" reveal	752.00	NA
PH90	Regular/Top jamb plunger hold open arm	909.00	1307.00
PHP90	Parallel/Top jamb plunger hold open arm	913.00	1404.00
DS90	Heavy duty parallel arm with stop	783.00	1266.00
DST90	Heavy duty parallel arm with hold open and stop	851.00	1388.00
SDS90	Heavy duty parallel arm with compression stop	998.00	1666.00
SDST90	Heavy duty parallel arm with hold open and compression stop	1063.00	1738.00
IS90	Heavy duty regular/top jamb arm with stop	1021.00	1490.00
ISH90	Heavy duty regular/top jamb arm with hold open and stop	1043.00	NA
SIS90	Heavy duty regular/top jamb arm with compression stop	1043.00	1694.00
SISH90	Heavy duty regular/top jamb arm with hold open and compression stop	1211.00	NA
ISJ90	Heavy duty top jamb arm with stop for 3-1/2"-6-1/2" reveal	1058.00	1518.00
ISJH90	Heavy duty top jamb arm with hold open and stop for 3-1/2"-6-1/2" reveal	1128.00	NA
SISJ90	Heavy duty top jamb arm with compression stop for 3-1/2"-6-1/2" reveal	1173.00	1726.00
SISJH90	Heavy duty top jamb arm with hold open and compression stop for 3-1/2"-6-1/2" reveal	1243.00	NA
SPA90	Heavy duty parallel arm	735.00	1268.00
SPAT90	Heavy duty parallel arm with thumb-turn hold open	802.00	1266.00
T90	Track arm, pull side door mounted	752.00	1268.00
FT90	Flush track arm, push side transom mounted	752.00	1268.00
JT90	Jamb track, pull side frame mounted	752.00	1268.00
PT90	Push track arm, push side soffit mounted	752.00	1268.00
TDE90L	Track arm double egress, pull side frame mounted, left handed	878.00	NA
TDE90R	Track arm double egress, pull side frame mounted, right handed	878.00	NA
TH90	Track arm with hold open, pull side door mounted	786.00	1303.00
FTH90	Flush track arm with hold open, push side transom mounted	786.00	1303.00
JTH90	Jamb track with hold open, pull side frame mounted	786.00	1303.00
PTH90	Push track arm with hold open, push side soffit mounted	786.00	1303.00
TDEH90L	Track arm with hold open double egress, pull side frame mounted, left handed	912.00	NA
TDEH90R	Track arm with hold open double egress, pull side frame mounted, right handed	912.00	NA

Body Add-On Options

Option	Category	Description	List Add
AVB	Body	AVB body ships automatically unless other option is specified in nomenclature	Incl
DA AVB	Body	Combination of both DA + AVB - must be specified in nomenclature	Add 49.00

Cover Add-On Options

Option	Category	Description	List Add
PC90	Cover	Full size plastic cover ships automatically unless other option is specified in nomenclature	Incl
MC90	Cover	Metal cover non-handed (removable mouse hole)	Add 56.00
LL90	Cover	Lead lined cover non-handed (removable mouse hole)	Add 83.00

Accessories Bracket Add-On Options

Item	Category	Description	List Add Painted	List Add Plated
PD90		PA bracket for non hold open arm applications to clear surface applied stop / holder	60.00	128.00
PFT90		PA bracket for hold open and non hold open applications to mount PFT bracket flush to transom	46.00	122.00
PHB90		PA bracket for friction hold open arm. Included w/ with FHP arm	28.00	109.00
P90		PA bracket for non hold open arm applications	46.00	122.00
FTHD90		Angled flush transom bracket for heavy duty PA applications where normal soffit conditions don't exist	63.00	NA
MJ90		Mortised jamb bracket for reg mount non hold open applications where normal foot can't be used	40.00	NA

Fastener Add-On Options

Option	Category	Description	List Add
SNDTPK90	Fastener	SNDTPK90 ships automatically unless other option is specified in nomenclature	Incl.
TX90	Fastener	Torx security screws	Add 49.00

Accessory Plate Add-On Options

Item	Category	Description	List Add Painted	List Add Plated
BP90	Backplate	Backplate typically for TJ mount closer body w/ restricted ceiling clearance	85.00	NA
DP90	Drop plate	Drop plate for PA mounted closer body to doors' top rail or TJ w/ restricted ceiling clearance	85.00	NA

Accessories

Item	Category	Description	List Add Painted	List Add Plated
AB90	Bracket	Angle bracket for PA and TJ mount where field conditions require to mount closer body to bracket	85.00	NA
BSD90	Spacer	Blade stop spacer for HD PA mounted applications. Spacer fits against frame's stop	41.00	NA
NFHD90	Bracket	Angled narrow frame bracket to give support to HD PA arms. Used in conjunction with BSD	40.00	116.00
BSNFHD90	Kit	BSD90 + NFHD90 kit	81.00	NA

Custom /Designer Colour Add-On Options

Option	Category	Description	List Add
RAL Custom Color	Finish	Custom painted finish selected from RAL color pallet book. (Per order; per color set up, net; no discount applied)	Net 143.00
RAL Custom Color	Finish	Per closer	Add 50.00
Designer Color	Finish	Designer painted finish color matched to supplied samples. (3"x 2"x 3" samples required) (Per order; per color set up, net; no discount applied)	Net 325.00
Designer Color	Finish	Per closer	Add 50.00

Body Package Less Arm

Item	Description	List Painted	List Plated
EHD9016 LA	Adj 1-6 +50% power advanced variable backcheck closer AVB with/ PC90 cover & SNDTPK90	568.00	941.00
EHD9016 DA AVB LA	Adj 1-6 +50% power delayed action, advanced variable backcheck closer w/ PC90 cover SNDTPK90	616.00	990.00

Accessories

Item	Description	List Add Painted	List Add Plated
AF90P	Standard flat form arm, tri-pack	151.00	349.00
AF90J	Top jamb flat form arm for 4-8" reveal	143.00	261.00
AF90	Regular or top jamb flat form arm for 4" reveals	141.00	258.00
FH90	Friction hold open arm	178.00	NA
FHP90	Friction hold open arm, tri-pack	191.00	NA
FHJ90	Top jamb friction hold open arm for 4-8" reveal	184.00	NA

Accessories

Item	Description	List Add Painted	List Add Plated
PH90	Regular/Top jamb plunger hold open arm	281.00	500.00
PHP90	Parallel/Top jamb plunger hold open arm	286.00	609.00
DS90	Heavy duty parallel arm with stop	210.00	396.00
DST90	Heavy duty parallel arm with hold open and stop	269.00	453.00
SDS90	Heavy duty parallel arm with compression stop	384.00	534.00
SDST90	Heavy duty parallel arm with hold open and compression stop	446.00	593.00
IS90	Heavy duty regular/top jamb arm with stop	376.00	604.00
ISH90	Heavy duty regular/top jamb arm with hold open and stop	432.00	NA
SIS90	Heavy duty regular/top jamb arm with compression stop	469.00	738.00
SISH90	Heavy duty regular/top jamb arm with hold open and compression stop	528.00	NA
ISJ90	Heavy duty top jamb arm with stop for 3-1/2"-6-1/2" reveal	406.00	628.00
ISJH90	Heavy duty top jamb arm with hold open and stop for 3-1/2"-6-1/2" reveal	462.00	NA
SISJ90	Heavy duty top jamb arm with compression stop for 3-1/2"-6-1/2" reveal	499.00	605.00
SISJH90	Heavy duty top jamb arm with hold open and compression stop for 3-1/2"-6-1/2" reveal	557.00	NA
SPA90	Heavy duty parallel arm	168.00	352.00
SPAT90	Heavy duty parallel arm with thumb-turn hold open	227.00	410.00
T90	Track arm, pull side door mounted	184.00	428.00
FT90	Flush track arm, push side transom mounted	184.00	428.00
JT90	Jamb track, pull side frame mounted	184.00	428.00
PT90	Push track arm, push side soffit mounted	184.00	428.00
TDE90L	Track arm double egress, pull side frame mounted, left handed	261.00	NA
TDE90R	Track arm double egress, pull side frame mounted, right handed	261.00	NA
TH90	Track arm with hold open, pull side door mounted	215.00	458.00
FTH90	Flush track arm with hold open, push side transom mounted	215.00	458.00
JTH90	Jamb track with hold open, pull side frame mounted	215.00	458.00
PTH90	Push track arm with hold open, push side soffit mounted	215.00	458.00
TDEH90L	Track arm with hold open double egress, pull side frame mounted, left handed	289.00	NA
TDEH90R	Track arm with hold open double egress, pull side frame mounted, right handed	289.00	NA
M8X30	Arm screw only (arm type determines screw)	6.00	NA
M8X16	Arm screw only (arm type determines screw)	6.00	NA
SNDTPK90	Standard self-drilling, self tapping and through bolts (replacement pack)	46.00	NA

Quoting & Ordering

Price quotations are based on one (1) shipment to one (1) location, and are valid as identified in the quote but in no case longer than one year from the date of the quote. All exceptions will be evaluated on an individual basis.

All quotation requests will be provided by the dormakaba USA Inc. ("dormakaba USA") Representative where the project is located.

QUOTING PROCESS AND PROCEDURES: The following information is necessary to secure a price quotation from dormakaba USA.

- Distributor Name
- Distributor Location
- Distributor Contact Name and Phone Number
- Distributor e-mail contact
- Project Name
- Project Location
- Bid Date
- Architects Name, Phone Number and Architects Location
- Specification Writer Name, Phone Number and Location
- Competitive Influence / Specification

List of materials to be quoted Every attempt will be made by dormakaba USA to provide the price quotation in a timely manner. Upon completion, you will receive a copy of the quotation which will also include a valid quotation number. Once the project is secured, a copy of the quotation must accompany your purchase order and be forwarded to dormakaba USA Customer Service Department in Indianapolis for processing.

NON-STANDARD PRODUCT REQUEST: Please contact your dormakaba USA Representative to complete a Non-Standard Product Request Form.

All requests should be submitted to the following email address:
Email: product.request.us@dormakaba.com

Upon receipt of a special order request, dormakaba USA will review the configuration and determine if dormakaba USA is capable of making the special order product and will provide a response to the customer. If dormakaba USA is able to make the special order product, dormakaba USA will provide a specific sku/configuration to the customer for the special order product. This sku/configuration must be identified on all Purchase Orders. In addition, the Purchase Order must be marked as a "Special Order".

ORDERING: The following information is required for dormakaba USA to successfully process any order:

- Itemized Purchase Order (PO)
- dormakaba USA Approved Quote

Please send all orders to BAS-orderentry.us@dormakaba.com or by fax to 877-835-1030

NOTE: For detailed information on how to place an order for dormakaba USA products as well as BEST masterkey services please see the detailed section regarding "Best Ordering".

ADD ON ORDERS FOR QUOTED PROJECTS: To place an add-on order from a quoted project the Distributor must include the original quote, PO number and/or dormakaba USA's original order number. Add-On orders will be accepted for a period one (1) year from the original order date. Add-On orders received that are outside of the aforementioned period will be forwarded to the dormakaba USA Representative for re-quote.

STOCKING ORDERS: All orders for stock replenishment should be marked as "Stock" and indicate a "Ship To" address that coincides with the stocking Distributor warehouse location.

INCOMPLETE ORDER PROCESS: All orders are screened upon receipt for complete information. If an order is received incomplete, dormakaba USA Customer Service will make one (1) attempt to contact a Distributor directly for the missing requirements. If the information is not made available to dormakaba USA at that time the order will be referred to the local dormakaba USA Representative for resolution. All incomplete orders will be cancelled if not resolved after fourteen (14) calendar days.

PRICE DISCREPANCY PROCESS: All entered orders are reviewed by dormakaba USA Customer Service for accuracy and pricing consistency between the Distributor and dormakaba USA. Any order determined by dormakaba USA, in its sole and absolute discretion, to have a value greater than the Total Price shown on the Distributor purchase order will be held by dormakaba USA for a Price Discrepancy. dormakaba USA quotes are also reviewed to ensure that they are complete, approved, and match the PO. Due to pricing sensitivity, all price discrepancies must be resolved exclusively by your dormakaba USA Representative.

ORDER CANCELLATION/CHANGES: All requests for Order Cancellations and Changes (Quantity, Shipping, Finish, Function, etc) should be sent directly to dormakaba USA Customer Service. Requests via phone will be accepted, but must be accompanied by a written request. Factory Order Number, PO Number, Account Info, and Detailed Changes must be clearly indicated. Change requests can be submitted via the following methods:

Email: BAS-cshelp.us@dormakaba.com
Fax: 1-877-835-1030

All order cancellations or changes will be subject to a cancellation fee as defined in dormakaba USA's Terms and Conditions of Sale.

PRODUCTION SCHEDULING AND "DO NOT SHIP BEFORE" REQUESTS: All orders are scheduled for production and shipping based on current production lead times and availability. Scheduling is completed only when an order is released from both credit and pricing review.

Exceptions to this policy are made only when the PO is clearly marked: "Do Not Ship Before" followed by the date. (Required Date, Expected Date, etc. do not apply) These orders will be scheduled to ship on or after the date listed.

Changes to "Do Not Ship Before" dates are required in writing and should be sent to: BAS-cshelp.us@dormakaba.com.

Be advised, orders not clearly marked with a "Do Not Ship Before" designation will be payable within normal terms from the actual shipment date.

EXPEDITE REQUESTS:

- Expedite requests will be reviewed and accommodated by dormakaba USA based on production lead times and availability.
Email: BAS-expediterequest.us@dormakaba.com
- See the then current dormakaba USA Quick Ship Program for details.

WHOLESALE PURCHASE: Distributors are also free to utilize dormakaba USA's Authorized Wholesalers to purchase product. dormakaba USA does not make any guarantee of availability or pricing for purchases from an Authorized Wholesaler and the discounts afforded to Distributor by dormakaba USA shall not apply to purchases from an Authorized Wholesaler. The terms and conditions and price of product shall be as mutually agreed between Distributor and Wholesaler.

BEST Ordering

ORDER ENTRY REQUIREMENTS: The following information is required for dormakaba USA Inc. ("dormakaba USA") to successfully process an order for dormakaba USA Best Products:

Orders Requiring Factory Master Key Services:

- Itemized Purchase Order (PO)
- Completed Keying Request Information Form
- Hardware Schedule in support of a construction project
- dormakaba USA Approved Quote

Orders NOT Requiring Factory Master Key Services:

- Purchase Order
- General Contractor information (City/State/Zip)
- dormakaba USA Approved Quote

KEYING SYSTEM ORDERS: All orders of keying systems specifying delayed fulfillment must be fulfilled within twelve (12) months of the order date. Said request for fulfillment must include complete keying instructions for the order to be acknowledged with an estimated delivery date. Failure to properly request fulfillment of the order within twelve (12) months of the order date will make the order void and nonrefundable.

Pricing for all new construction key operated locks include the following:

- Combined or uncombined permanent cores will be provided with 2 keys per core.
- "Core only" orders will be provided with 2 keys per core.

Pricing for all retrofit key operated locks include the following:

- Combined cores will be provided with 1 key per core.
- Uncombined cores will be provided with 0 keys. All keys will need to be purchased separately.

All new purchase orders should be e-mailed to your local dormakaba USA Representative or BAS-orderentry.us@dormakaba.com.

HARDWARE SCHEDULE & NEW CONSTRUCTION PROJECT ORDERS: A hardware schedule should be submitted for all new construction projects. A hardware schedule is a listing of all builders hardware items related to a particular construction job. It is approved by the architect (or an entity performing that function). A hardware schedule of Best products is one in which the material ordered is compatible for installation as required in the schedule. Remember complete door schedules include door number, door location, and type of hardware. An example of a preferred hardware schedule format is illustrated below:

Project Sample			
Hardware Set 01			
1	SGL DOOR 101A	CORRIDOR 100 FROM CLASSROOM 101	90 DEG RHR
		3/0 x 7/0 x 1-3/4 HMF x SWD	
3	HINGES	FBB179 4 5 x 4 5	852
1	CLASSROOM LOCKSET	83K 7 R 14D S3 STD	628
1	CLOSER	D-4551 CS	889
1	KICKPLATE	8" x 34" x .050	630
3	MUTES		GREY

COMBINATED CORE ONLY ORDERS: All Core-Only orders, in an amount of 25 cores or more, require a Hardware Schedule, Keying Request Information Form, and Itemized Purchase Order (PO).

LESS CORE LOCK ORDERS PURCHASED DIRECTLY FROM dormakaba USA: Less core lock orders generally apply to orders where the end user is providing their own permanent cores.

CABINET LOCK ORDERS:

The following information must be provided for Cabinet Lock Orders:

- End User Name
- End User Address Information (Street/City/State/Zip)
- End User Phone
- End User Fax and/or e-mail

DISTRIBUTOR PERMANENT KEYING

POLICY: Locks when ordered for construction projects to include "Final Keying" will be provided to Distributor with construction core access, whereby plastic thumb turns are supplied for use during construction. Additionally, brass construction cores can be purchased by the Distributor, upon request, to secure exterior doors or special interior doors.

The permanent masterkeyed cores are shipped directly to the end user upon written approval of the final keying. It is the responsibility of the Distributor to collect all temporary construction cores after use.

PROCESS:

- 1) Distributor places complete order with dormakaba USA Customer Service, Indianapolis
- 2) Distributor, KSS, and End User Consultant (EUC) receive acknowledgement of order with expected ship date.
- 3) KSS/Distributor contacts the end user within a reasonable period of time after receipt of purchase order or acknowledgment to begin the permanent keying process.
- 4) KSS/Distributor works with end user to define keying requirements.
- 5) Once keying requirements are finalized and approved, production of cores and keys begins.
- 6) Cores and keys are shipped to end user or end user delegate (NOTE: Unless special arrangements are made the end user is responsible for permanent core installation).

Complete Order Checklist

- PO Number
- Hardware Schedule
- Completed Keying Request Information Form

The KSS/Distributor works directly with the end user to acquire keying instructions for the permanent masterkeyed cores and keys, including both new system design and existing system expansion, according to the project requirements. The KSS/Distributor also manages the process from keying instructions to delivery and can serve as a point of contact for information on the progress of permanent core/key delivery completion.

BEST Ordering (continued)

SERVICE DELIVERY:

Permanent Core delivery is contingent upon several factors such as:

- The negotiated delivery dates as determined between the end user, Distributor and dormakaba USA during the keying review and design processes;
- End user's written approval of the keying instructions;
- Size and complexity of the keying system being produced; and
- dormakaba USA's receipt of payment from the Distributor.

GENERAL:

- Remember to furnish door and location information for all "tag-in" orders (add-ons to initial project orders).
- If you have advanced knowledge that your project will be phased and require multiple orders from dormakaba USA, please include these in your order.
- A master hardware schedule for phased projects is always preferred.

CONSTRUCTION CORE ORDERS

All keyed locks shipped from dormakaba USA for new construction projects in which cores have been ordered will receive disposable black plastic (non-keyed) construction cores at no additional charge.

Disposable black plastic cores for less-core orders may be purchased separately for \$2.00 net.

Standard brass (keyed-alike) construction cores may be purchased for a net price of \$9.90 each.

No further discount will be applied.

Brass construction cores shall be 7-pin, A keyway and have a GREEN face.

Brass construction cores are shipped with one operating key per ten (10) cores or less and one control key per twenty (20) cores or less; additional keys may be purchased for \$7.40 list.

Construction cores do not have the degree of security that the owner's permanent masterkeyed cores provide. Construction cores are used for controlling access to premises during construction and ARE NOT INTENDED FOR USE WHEN PREMISES ARE OCCUPIED OR FURNISHED IN ANY MANNER.

Construction Cores and Keys

Part Number:	Description	Net price each (if purchased separately)
7181139	Disposable Core (Black Plastic)	\$2.00 Net
7190246 (5c)	Standard Brass Keyed Alike 5c construction Core – Green Face	\$9.90 Net
7186163 (6p)	Standard Brass Keyed Alike 6 pin construction Core – Green Face	\$9.90 Net
7190224 (7p)	Standard Brass Keyed Alike 7 pin construction Core – Green Face	\$9.90 Net
7148872	Additional Operating Key	\$7.40 List
7147449	Additional Control Key	\$7.40 List

*No further discounting on Construction Core Net Pricing

RETURN OF CONSTRUCTION CORES: Brass construction cores may be returned for \$3.20 credit per re-usable core to be applied toward the next purchase. A Returned Goods Authorization (RGA) must be obtained and accompany the returned material.

dormakaba USA is not responsible for collection or return of construction cores.

BEST PINS: Best pins shall be used solely in combination with Best Core products. Use of other pins may void any associated product warranty and may result in termination of the Distributor's agreement with dormakaba USA, in dormakaba USA's sole discretion.

Returned Authorization (RA)

RA REQUESTS: A Return Authorization Form ("RA") must be utilized to return defective products **still under warranty** or products deemed repairable by dormakaba USA Inc. ("dormakaba USA"). All products returned to dormakaba USA must have a correct Return Authorization (RA) number applied to the outside of the shipping carton. All products must be returned within sixty (60) calendar days of RA issue date. This process can take up to seven (7) days after product is received at dormakaba USA's factory. If a defective product presents a security risk, an advance replacement may be requested.

RA PROCESS: Requests for warranty related returns can be initiated by submitting an e-mail to **BAS-rgacreditgrp.us@dormakaba.com**.

The RA Request Form must be completed entirely to process an RA. The following information will be needed:

- End User Name
- Account Number
- Contact Name
- Phone Number
- Purchaser Order Number
- Sales Order Number
- Item Number
- Item Quantity
- Description of the Problem

1. Upon review and approval of the submitted RA request, a claim number is logged and provided back to the requestor by a dormakaba USA Team member.
2. Once a claim number is issued, this number should be noted on all references and communications regarding the applicable situation to ensure a claim is easily identified.
3. Defective product should be returned to the address below. The shipment must be marked with the approved RA claim number to ensure prompt processing and attention. All shipping charges prepaid by customer.
dormakaba USA Inc.
Attn: Returns Department
6161 East 75th Street
Indianapolis, IN 46250
4. When material is received at dormakaba USA's factory, dormakaba USA will assess and determine the nature of the defect.
6. Defective goods are replaced upon dormakaba USA's determination.
6. Credit for material and freight is issued only if deemed appropriate by dormakaba USA. If approved, credit is initiated and a credit memo is mailed to the Distributor within fifteen (15) business days.

PURCHASE ORDERS:

A Purchase Order (PO) will be required if the Product is:

1. Defective and not under warranty, or
2. An advance replacement is required without verification of whether the product is defective and under warranty.

Please send Purchase Orders to the following:

- Preferred Method e-mail:
BAS-rgacreditgrp.us@dormakaba.com
- Fax: 1-877-835-1030

Returned Authorization (RA) Non-Warranty

RA POLICY: A Return Authorization Form ("RA") must be utilized to return products that are not defective and otherwise in a resalable condition. Only goods with an invoice date of less than one (1) year will be considered for a non-warranty related return. All materials returned to dormakaba USA Inc. ("dormakaba USA") for any reason (other than warranty), must have a correct RA number applied to the outside of the shipping carton. A standard re-stocking charge (of the purchase price) will be applied to the Distributor's account for orders returned, including orders that were placed by customer in error. Transportation charges of returned goods must be prepaid by the Distributor. All goods must be returned within sixty (60) calendar days of RA issue date. All goods must be returned in original packaging and be in resalable condition. Product not returned in saleable condition is subject to disposal by dormakaba USA with no credit issued. Commercial Hardware items that are special made to order items will not be returned under any circumstances.

RA PROCESS: Requests for non-warranty related returns can be initiated by submitting an e-mail to **BAS-rgacreditgrp.us@dormakaba.com**.

The RA Request Form must be completed entirely to process an RA. The following information will be needed:

- Company Name
 - Account Number
 - Contact Name
 - Purchaser Order Number
 - Sales Order Number
 - Item Number
 - Item Quantity
 - Phone Number
 - Description of the Problem
1. Upon review and approval of the submitted RA request, a claim number is logged and provided back to the requestor by a dormakaba USA Team member:
 2. Once a claim number is issued, this number should be noted on all references and communications concerning said RA.
 3. Product should be returned to the address below. The shipment must be marked with the approved RA claim number to ensure prompt processing and attention. All shipping charges prepaid by customer.
dormakaba USA Inc.
Attn: Returns Department
6161 East 75th Street
Indianapolis, IN 46250
 4. The RA will be processed once material is received at dormakaba USA's factory provided it is received in its original packaging and is in saleable condition.
 5. Credit is issued to the Distributor account and a credit memo is mailed to the Distributor.

Fulfillment Issues

Any quality issues (missing parts, wrong parts, handling, finish, etc) should be submitted electronically to: **BAS-rgacreditgrp.us@dormakaba.com** or your Local dormakaba USA Representative.

Please reference your original Purchase Order (PO) Number, Factory Order Number, Distributor Account, Contact Information (E-mail/Fax), and include a detailed description of the issue.

1) ITEMS MISSING FROM A SHIPMENT: If you have signed your shipment short, dormakaba USA Customer Service will promptly issue a No Charge replacement order for the missing products.

If the shipment was not signed short but after review, dormakaba USA Customer Service determines (based on shipping weights, packing lists, etc) that the order was indeed shipped short, a No Charge replacement will be issued.

If dormakaba USA Customer Service cannot verify a shipping error, an advance replacement order will be entered, charged, and expedited to the Distributor. The quality issue will be forwarded to the Return Authorization Credit Group for resolution.

If it is determined that the item was omitted from the order due to a dormakaba USA order entry error, a change order will be entered and expedited for the missing products.

Please see price book for further detail.

2) WRONG ITEMS RECEIVED (parts, handling, function, finish, etc):
Advanced replacements will be issued for any wrong items received. **Such orders will be charged based on pricing/discounts from the original order.** The issue will be forwarded to dormakaba USA's Return Authorization Credit Group for resolution.

Any quality issue that is determined to be either a dormakaba USA order entry and/or manufacturing error will have an advanced replacement order entered and will be expedited. An RA will be issued to return the incorrect products. No re-stock fee will apply for dormakaba USA order entry and/or manufacturing errors.

Keying Request Information Form

CUSTOMER
NUMBER:

**MUST BE SUBMITTED WITH COMPLETE INFORMATION,
INCLUDING P.O. & HARDWARE SCHEDULE**

Quote #: _____ Discount %: _____
If received
Distributor P.O. #: _____ Price List: _____

REQUIRED INFORMATION REGARDING dormakaba USA Inc. DISTRIBUTOR

Distributor: _____
Distributor Account #: _____
Project Manager: _____
Project Manager Mobile: _____ Project Manager E-mail: _____
Address: _____
City, State, Zip: _____
Phone: _____ Fax: _____

REQUIRED INFORMATION REGARDING PROJECT CONTRACTOR

Contractor: _____
Job Name*: _____
Contact Person: _____
Contact Mobile*: _____ Contact E-mail*: _____

REQUIRED INFORMATION REGARDING THE END USER

Company*: _____
Contact Person*: _____
Contact E-mail*: _____ Contact Phone #*: _____
School Name (if applicable): _____
School District (if applicable): _____
Permanent Core Due Date*: _____
Building Turnover Date: _____
Project Address*: _____
City, State, Zip*: _____
Phone*: _____ Fax: _____

Masterkey Account #: _____
Keyway: _____

NOTE: Failure to provide complete and accurate end user information will result in delays in processing and supply of permanent core and key orders.
Failure to include this form with your order and the hardware schedule may result in the order being processed "less core".
*REQUIRED Field

Dormakaba BEST® Patented Masterkey System Security Authorization Form

The purpose of this form is for the end user to designate representatives who are authorized to place an order for dormakaba BEST® patented cores or keys and to confirm the correct shipping address for dormakaba BEST® Patented product. It is the responsibility of the Distributor to ensure that the end user completes a Security Authorization Form and submits it to dormakaba with each order and applies to this Purchase only.

The dormakaba BEST® Patented Masterkey System provides a higher level of protection against unauthorized key duplication and crossovers. To help ensure that dormakaba BEST® patented cores and keys do not end up in the possession of unauthorized personnel, dormakaba will only authorize sales and shipment of dormakaba BEST® patented cores and keys to the individuals noted on this form. Please complete this form carefully as dormakaba and/or its Authorized Distributor will strictly adhere to this information.

END USER:

End User Company Name

Account Number

SECURITY AUTHORIZED PERSONNEL: Please provide the names of all security personnel who are authorized to place purchase orders for End User's dormakaba BEST® Patented Masterkey Systems.

1.

Name

Street Address

Title

City, State, Zip

Phone Number

E-mail Address

Date

Signature

2.

Name

Street Address

Title

City, State, Zip

Phone Number

E-mail Address

Date

Signature

3.

Name

Street Address

Title

City, State, Zip

Phone Number

E-mail Address

Date

Signature

Dormakaba BEST® Patented Masterkey System Security Authorization Form (cont.)

AUTHORIZED DISTRIBUTOR: Please insert the name below of the Authorized Distributor that you that you assign and authorize to place orders for dormakaba BEST® Patented Product on your behalf.

1. _____
Name Street Address

Title City, State, Zip

Phone Number E-mail Address

Date Signature

SHIPPING ADDRESS: Please provide the address where you would like all dormakaba BEST® Patented Product shipped.

Department

Street Address

City, State, Zip

ACCEPTABLE METHOD FOR PLACING ORDERS: please identify below the method that you authorize for placement of orders for dormakaba BEST® Patented Product.

- Signature Verification** – dormakaba may only accept purchase orders that have been signed by one of the individuals designated on this form by the End User. dormakaba will verify that the signatures match before initiating activity on the order. dormakaba will not initiate activity until the original P.O. has been received.
- Email Verification** – dormakaba may accept electronic purchase orders from the email accounts designated on this form by the End User. dormakaba will verify that the email account sending the purchase order has been designated as an authorized purchaser. Purchase orders received from accounts not listed will not be accepted.
- Fax Verification** – dormakaba may accept purchase orders via fax from one of the individuals designated on this form by the End User. dormakaba will verify that the individual placing the order has been designated as an authorized purchaser.

dormakaba BEST® MASTERKEY CODE & MASTERKEY SERVICE POLICY: In accordance with the dormakaba BEST® Masterkey Code and Masterkey Service Policy, all dormakaba BEST® Patented Masterkey Codes and combinations are available for distribution solely to end users and select Authorized Distributors. To assist in reducing the possibility of duplication within a dormakaba BEST® Patented Masterkey System and ensure security, all dormakaba BEST® Patented Masterkey Code extensions and next in series codes should be made or approved by dormakaba Masterkey personnel and/or the Distributors that have been authorized by dormakaba to have access to dormakaba BEST® Patented Masterkey Codes, un-combined cores and key blanks. Duplication or release of dormakaba Patented BEST® Masterkey Codes to non-authorized people or organizations, including, but not limited to, unauthorized distributors, wholesalers, private locksmiths, other lock manufacturers, architects, or contractors violates dormakaba's ownership rights and is strictly prohibited.

By signing below, End User acknowledges that 1) the information provided above is accurate and correct and 2) that any unauthorized use including, but not limited to, the transmission or dissemination of dormakaba BEST® Patented Masterkey Codes, without the express written consent of dormakaba is strictly prohibited.

End User Signature: _____

Title*: _____ Date: _____



CORPORATE HEADQUARTERS

6161 EAST 75TH STREET
INDIANAPOLIS, IN 46250 USA

Phone 855-365-2407

bestaccess.com

For questions about ordering and to be sure you get the right configuration for your needs, [contact your BEST dormakaba sales representative](#).
6161 East 75th Street, Indianapolis, IN 46250 USA | [855-365-2407](tel:855-365-2407) | bestaccess.com

BEST is a trademark of dormakaba Holding® 2023 All rights reserved. BEST is a member of the dormakaba Group, one of the top three providers for access and security solutions, globally.

PL76 BST 01-24 R2

dormakaba 