



# BEST Hinges & Door Accessories

## Canada Price List

PL76 | January 2024 R1



BEST: Setting the Standard for Security

# What's New

This price book PL76 dated January 2024 R1 contains updated product information and some pricing. All changes are listed below and take effect immediately.

## BEST Hinges

- No change to pricing
- Updates to unlisted finishes for architectural hinges [pg 13]
- Multiple selection changed from 1 Ea to 30 Ea for all Quick Shim hinges: QKSFBB168 QKSFBB168NRP, QKSFBB179 QKSFBB179NRP, QKSFBB191 QKSFBB191NRP, QKSFBB199 and QKSFBB199NRP
- Some product descriptions clarified or updated
- Pricing for part 711950763 (wood screws for AL based continuous) adjusted



# Contents

Terms and Conditions of Sale	3
Hinge Sizes	6
<b>Hinges Options</b>	<b>7</b>
Finish Symbols and BHMA Finish Numbers	8
Quick Connect Harness	9
Pricing Extras	10-13
Emergency Hardware	14
Five Knuckle Hinges	15-35
Pivot Reinforced Hinges	36-38
Five Knuckle Swing Clear Hinges	39-41
Wardrobe Pivots	42
Steel and Stainless Steel Continuous Hinges	46-48
Aluminum Continuous Hinges	49-57
Two Knuckle Hinges	58
Residential Hinges	58
Detention Hinges	59
Three Knuckle Hinges	60-73
Spring Hinges	74-76
Miscellaneous Parts	77
EDP Number to Class Number Cross Reference	78-95
Quoting & Ordering	96
Returns	97-99

## BEST Hinges Contact Information

Hours of Operation: Monday – Friday, 8:00 am – 5:00 pm EST  
Toll Free Phone: 1-888-539-7226  
[www.bestaccess.com/hinges](http://www.bestaccess.com/hinges)

**Acceptance.** The following Terms and Conditions of sale are applicable to all Quotations, Contract, Purchase Orders, Order Acknowledgement Forms, and sales of Seller's services and products, and are the only applicable terms and conditions thereto, except for terms establishing prices, quantities, delivery schedules, terms of payment, invoicing, shipping instructions, and the identification of the products associated with each transaction. If any conflict exists between the Terms and Conditions and a Quotation, Purchase Order, Order Acknowledgement form, or sale, these Terms and Conditions shall prevail BY REQUESTING A QUOTATION OF ORDERING ANY PRODUCTS OR SERVICES FROM SELLER, BUYER AGREES TO ALL THE FOLLOWING TERMS AND CONDITIONS. If a written contract signed by both parties is in existence covering the sale of the goods and services, the terms and conditions of the contract shall control to the extent they are inconsistent with these Terms and Conditions.

**1. Order Procedure.** Buyer may or may not request the preparation of a Quotation prior to ordering any products or services from Seller. Buyer then shall place a Purchase Order with Seller. By placing a Purchase Order, Buyer makes an offer to purchase products or services from Seller pursuant to these Terms and Conditions. Seller, in its discretion, may accept or reject the Purchase Order. If Seller accepts the Purchase Order, Seller shall issue an Order Acknowledgement Form confirming Buyer's order. No Purchase Order is binding on Seller unless accepted by Seller as provided in these Terms and Conditions.

**2. Quotations.** All Quotations by Seller are subject to change or withdrawal without prior notice to Buyer unless otherwise specifically stated in the Quotation. Quotation prices are valid on Purchase Orders placed within 90 days of the quote being issued, unless otherwise specifically stated in the quotation. If no order is placed within the stated time frame, prices may be adjusted to reflect the then-current published prices, surcharges, escalators, or other pricing adjustment due to, among other things, costs of materials, labor, transportation, taxes, duties, and other cost increases to Seller. All resulting Purchase Orders become effective only if and when approved and accepted in writing by Seller by the issuance of its Order Acknowledgement Form. Seller reserves the right to discontinue manufacture of any products or change products materials, design, or specifications without notice.

Quotation prices are valid on Purchase Orders placed within 90 days of the quote being issued, unless otherwise specifically stated in this quotation. If no order is placed within the stated time frame, prices may be adjusted to reflect the then-current published prices, surcharges, escalators, or other pricing adjustment due to, among other things, costs of materials, labor, transportation, taxes, duties, and other cost increases to Seller. All resulting Purchase Orders become effective only if and when approved and accepted in writing by Seller by the issuance of its Order Acknowledgement Form. All Quotations and resulting orders are subject to Seller's Terms and Conditions set forth in the price book

### 3. Site Requirements.

a. The Quotation is contingent upon all work being performed during normal business hours unless otherwise negotiated and a mutually agreeable schedule. The Quotation is calculated on one continuous installation engagement based on acceptable site conditions where other dependent scopes have completed preparation for proposed materials (i.e. electrical work, floor work, adjacent construction). When Buyer has given authorization for work to begin, no other scopes may impede Seller's ability to complete installation in agreed upon area. Seller reserves the right to invoice for costs that are incurred due to unacceptable site conditions or delays by others resulting in additional installation visits.

b. Signed acceptance by Buyer of shop drawings and/or submittals shall be interpreted as acceptance that proposed scope is the correct interpretation of construction documents. Any field verification and/or work required by others as detailed in the submittal will be provided and coordinated by Buyer. Work shall

not begin nor shall orders be placed for any projects until all shop drawings and submittals have been approved in writing by Buyer.

**4. Warranty.** Seller warrants only that all products sold pursuant to a Quotation or Purchase Order will conform to the description in the Price Book and will be free from defects in workmanship and materials. The duration of each product warranty is dependent on the particular product. Refer to EAD & DHW warranty statement. Extended warranties may be available for an additional cost. Seller is not responsible for defects or damages caused by wear and tear, consumable materials, vandalism, fires, storms, floods, acts of God, misuse, abuse or alteration by any company other than Seller. Seller further warrants that Buyer will receive good and valid title to the products. Any claim on account of nonconforming or defective products or for any other cause whatsoever shall conclusively be deemed waived by Buyer unless written notice thereof is given to Seller promptly after discovery but no later than sixty (60) days from date of shipment. Seller shall have the right either to replace or repair any nonconforming or defective products, to refund the purchase price upon return of the products, or to grant a reasonable allowance on account of such nonconformance or defect Seller's liability and Buyer's exclusive remedy for nonconforming or defective products shall be limited solely to replacement, repair, refund, or allowance as Seller may elect. Seller shall be given reasonable opportunity to investigate all claims and no materials shall be returned to Seller until after inspection and approval by Seller and receipt by Buyer of written shipping instructions from Seller. Buyer acknowledges and agrees that the remedies set forth in this paragraph are Buyer's exclusive remedies for the delivery of nonconforming or defective products.

### Additional Warranties

- a) No credit will be provided for any work completed by others during warranty term.
- b) Warranty work will be performed during normal business hours with our standard response times. Any warranty work taking place beyond normal business hours or with expedited response time may be billable.
- c) Products repaired or replaced under the warranty are warranted only through the remainder of the original warranty period.

**Disclaimer of Further Warranties.** Except as set forth above, there is no warranty, representation, or condition of any kind, express or implied (including no warranty of merchantability or fitness of the products for any use contemplated by Buyer) concerning Seller's products or services and none shall be implied by law.

**5. Limitation of Liability and Remedies.** Seller shall not be liable, and Buyer waives all claims against Seller for any incidental, consequential, or special damages, including without limitation, lost revenues and profits even if Seller has been advised of the possibility of such damages. Buyer's exclusive remedy for any cause of action under these Terms and Conditions is a claim for damages and in no event will damages or any other recovery of any kind against Seller exceed the purchase price of the specific products or services as to which the claim is made. Seller will not be liable to Buyer for any loss, damage, or injury to persons or property resulting from the handling, storage, transportation, resale, or use of the products in manufacturing processes, or in combination with other substances, or otherwise.

**6. Intellectual Property Indemnification.** (a) Seller agrees to defend, indemnify and hold Buyer harmless against any claims, costs, damages, liability and expenses resulting from actual or alleged patent, trademark, or copyright infringement, misappropriation of confidential information, or violation of any other intellectual property right, domestic or foreign, in the selling or use of any part or product that is owned by Seller and that pertains to the subject matter of a Quotation, Purchase Order, or sale of products or services (provided that the product is not modified in anyway by Buyer or any other party, and that the product is used in the manner intended by Seller). If a suit or claim results in any injunction or

any other order that would prevent Seller from supplying any product falling under a Quotation, Purchase Order, or sale, or if the result of such a suit or claim would, in the reasonable opinion of Seller, otherwise cause Seller to be unable to supply such products, Seller shall have the right, at its option, if it so chooses, to do one or more of the following: (i) secure an appropriate license to permit Seller to continue supplying the products to Buyer; (ii) modify the relevant product so that it becomes non-infringing, provided that any modification does not cause any material change to the operation or performance of the product; or (iii) replace the relevant product with a non-infringing but practically equivalent product. (b) Buyer agrees to defend, indemnify, and hold Seller harmless against any claims, costs, damages, liability and expenses resulting from actual or alleged patent, trademark, or copyright infringement, misappropriation of confidential information, or violation of any other intellectual property right, domestic or foreign, in the making, using or selling of any product or using any process that is owned by Buyer or is designed or specified by Buyer and that pertains to the subject matter of a Quotation, Purchase Order, or sale.

**7. Ownership of Inventions.** All drawings, know-how, designs, confidential information, and the like disclosed to Buyer by Seller and all rights therein will remain the property of Seller. Buyer shall have no claim to, ownership interest in, no license to, or no rights to any information provided or communicated by Seller.

**8. Lead Times.** If applicable, lead times are based on standard requirements by factory to provide materials proposed. Ship dates will be provided as estimate only once order is placed with the factory. Adequate packaging will be provided for any normal shipping circumstance such that materials will be protected and labeled as required. Special packaging may be provided for an additional expense. Shipping will be cost effective unless expedited fees are accepted by Buyer. If materials are to be provided to job site or Buyer location, dormakaba will make an informed decision as to the best instruction to provide the shipping company. If materials are not required to have direct delivery, materials will be brought to branch for pickup by Buyer. All freight terms shall be FOB. Any claims for damage in transit or lost freight, receiving, and inspection of materials is the responsibility of Buyer. It is a requirement of Buyer to inspect and review all materials prior to accepting shipment.

**9. Title/Risk of Loss.** All products shall be shipped FOB Seller's manufacturing facility to Buyer's designated delivery location. Unless otherwise agreed by the parties, Seller shall select the method of and carrier for the products. Seller reserves the right to ship items in a single or in multiple shipments. Title and risk of loss to products ordered passes to Buyer upon delivery of the products to the freight carrier. Unless mutually agreed upon in writing, shipping dates are approximate and are based upon prompt receipt of all necessary information.

**10. Prices.** Quoted price is valid for 90 days. Seller reserve the right to revise quotations after the 90 days. All accepted Purchase Orders are subject to Seller's price in effect at time of shipment. Buyer shall be responsible for any increase in freight rates or transportation charges occurring after Seller prepared the Order Acknowledgment Form. on the Order Acknowledgment Form. Buyer shall pay to Seller in addition to the purchase price the amount of all fees, duties, licenses, and all sales, use, privilege, occupation, excise, or other taxes, federal, state, local, or foreign which Seller is required to pay or collect in connection with products or services sold to Buyer.

**11. Payments.** Unless otherwise agreed in writing between the parties, all Seller's invoices are payable within thirty (30) days of their date. Time is of the essence. Interest on past due amounts will be assessed at the rate of 2% per month (24% per annum), or the maximum allowable by law.

Seller reserves the right to full payment upon completion of work unless credit is pre-established. For any work requiring materials purchase or scheduling, a 50% deposit is due at time of proposal acceptance. Twenty percent (20%) of the Quotation, Purchase Order value may be billed after job award. Joint check agreements may be requested at the discretion of Seller. If payment is outstanding for any one account, work may be stopped and outstanding orders cancelled until account is restored.

Should Seller require the use of collection, attorney's fees, or fees for insufficient funds, Buyer agrees that these funds will be repaid to Seller. Seller retains the right to file a lien against all or part of the property being improved. Seller reserves the right to add a 2.5% charge if invoice becomes delinquent beyond terms.

**12. Cancellation.** In the event a Buyer's Purchase Order and the issuance of an Order Acceptance Form is cancelled, it will be subject to standard 35% restocking fees, cancellation fees, engineering fees, materials & freight costs incurred, and administrative fees. Standard cancellation is 20% of order as long as no materials have been ordered. Should Buyer release material orders, Buyer will be liable for that portion of the job and 20% of the remaining amount of work unperformed/unordered.

**13. Storage.** If applicable, Seller reserves the right to implement a storage fee if delivery is delayed after agreed upon date. Should project timeline require storage of materials, Seller reserves the right to bill for those materials at the time they have been received at a Seller location, Buyer location, or at job site. Certificate of insurance for stored materials can be provided to Buyer upon request. Signed acceptance by Buyer of shop drawings and/or submittals shall be interpreted as acceptance that proposed scope is the correct interpretation of construction documents. Any field verification and/or work required by others as detailed in the submittal will be provided and coordinated by Buyer.

**14. Insolvency.** Seller may, at any time or times, suspend performance of any order or require payment in cash, security, or other adequate assurance satisfactory to Seller when, in Seller's opinion, the financial condition of Buyer or other grounds for insecurity, including the filing of a petition for bankruptcy, warrant such action.

**15. Force Majeure.** Seller shall not be liable for any delay in fulfilling any order due to (a) fires, floods, strikes, or other labor disputes, accidents to machinery, acts of sabotage, riots, precedence or priorities granted at the request or for the benefit, directly or indirectly, of the federal or any state government or any subdivision or agency thereof, delays in transportation or lack of transportation facilities, restrictions imposed by federal or state legislation or rules of regulations thereunder; or (b) any cause beyond the control of Seller.

**16. Ownership of Equipment.** Unless otherwise agreed in a writing, all material, equipment, facilities, and special tooling, which term includes but is not limited to jigs, dies, fixtures, molds, patterns, special taps, special gauges, special test equipment, and manufacturing aids and replacements thereof, used in the manufacture of the products covered by any order shall remain the property of Seller. Any material, tooling, and equipment furnished to Seller by Buyer shall be and remain the personal property of Buyer with the title to and right of possession remaining in Buyer.

**17. Confidential Information.** All information furnished or made available by Seller to Buyer in connection with a transaction shall be held in confidence by Buyer. Buyer agrees not to use such information or disclose such information to others without Seller's prior written consent. The obligations of this paragraph does not apply to any information which (a) at the time of disclosure was, or thereafter becomes, generally available to the public by publication or otherwise through no breach by Buyer of any obligation herein, (b) Buyer can show by written records was in Buyer's possession prior to disclosure by the disclosing party, (c) is legally made available to Buyer by or through a third party having no direct or indirect confidentiality obligation to Seller with respect to such information, (d) was independently developed by Buyer without use of any of Seller's confidential information, or (e) is required to be disclosed pursuant to applicable law.

**18. Waiver.** No waiver by Seller of any of these Terms and Conditions shall be effective unless explicitly set forth in writing and signed by Seller. No failure to exercise, or delay in exercising, any rights, remedy, power, or privilege arising from these Terms and Conditions shall operate or be construed as a waiver thereof, nor shall any single or partial exercise of any right, remedy, power, or privilege hereunder preclude any other or further exercise thereof or the exercise of any other right, remedy,



power or privilege.

**19. Assignment.** No assignment of any right or interest or delegation of any obligation or performance of Buyer under this order may be made without the prior written consent of Seller. Any attempted assignment or delegation will be wholly void and totally ineffective for all purposes.

**20. Choice of Law.** All sales, agreements for sale, offers to sell, proposals, acknowledgments and contracts of sale, including, but not limited to, Purchase Orders accepted by Seller, shall be considered a contract under the laws of the State of Delaware, and the rights and duties of all persons, and the construction and effect of all provisions hereof, shall be governed by and construed according to the laws of the State of Delaware.

**21. Integration Clause.** These Terms and Conditions constitute the entirety of terms and conditions, except as set forth in paragraph one, governing the sale and purchase of products and services sold by Seller. No modification of these Terms and Conditions shall be of any force or effect unless in writing and signed Seller and Buyer. Buyer may desire to utilize its own form of acknowledgment or acceptance of these Terms and Conditions. However, the use of any such form shall be for convenience only. No modification of these Terms and Conditions shall be affected by the acknowledgment or acceptance of purchase orders, shipping instruction forms, bills of lading or any other document containing terms or conditions at variance with or in addition to those set forth herein, all such varying or additional terms being hereby objected to and rejected by Seller and deemed to be waived by Buyer.

**22. Installation Projects. Communication:** Buyer shall communicate all of these installation terms to any end-user receiving installation services from dormakaba. **Work Execution:** Any installation quote is prepared with the understanding that openings within the scope of work ["Work"] have doors and frames in good working order. dormakaba will perform the Work in the order set forth in a field survey conducted by an end-user, an end-user consultant, or Buyer prior to beginning the installation. Work shall occur weekdays during normal business hours (M-F, 8am – 5pm, local time). Work performed outside of normal business hours is available at a rate of 135% of the normal base rate. Any Work requested to be performed outside of normal business hours will require start and stop time confirmation with installation site, such start and stop time to be obtained by the Buyer or the end-user. Installation Projects are performed as one continuous installation event, from commencement until the completion of the installation. Unless specifically noted otherwise in writing, there will be additional charges for delays or additional trips not caused by dormakaba. Commencement of installation is conditioned on acceptable site conditions, including the completion of dependent scopes of work (e.g., electrical work, keying meetings, distribution of credentials). When Buyer or end-user has given authorization for work to begin, Buyer or end-user shall ensure no other scopes may impede dormakaba's ability to complete installation in agreed upon area. dormakaba reserves the right to assess a fee for costs incurred due to unacceptable site conditions or delays by others resulting in additional installation visits. Union labor, prevailing wage, and certified payroll are excluded from the installation quote unless otherwise set forth in writing. Insurance certificates will be provided upon request. Coverage is limited to the types and amounts set forth on the insurance certificate. Includes execution of materials only as detailed within proposal. **Additional Charges:** Additional charges may be assessed for delays or additional install time to correct any deficiencies or discrepancies between scope of work and actual jobsite. Any dormakaba materials delivered to Buyer but missing from installation site will be reordered at customer's expense. Any hardware changes or change orders shall be quoted on a separate proposal and timeline. **Storage:** dormakaba reserves the right to assess a storage fee if Buyer or end-user causes delivery to be delayed after the agreed upon delivery date. Should project timeline require storage of materials after delivery to Buyer or end-user, through no act or omission of dormakaba, dormakaba reserves the right to assess a storage fee, Buyer location, or at job site. Certificate of insurance for stored materials can be provided to Buyer upon request. **Exclusions:** Unless explicitly included in the installation quote, these are excluded: Distribution to staff of any form of keys, fobs or cards or credentials; any temporary security, barricades, or signage; all carpentry work outside of this specification including drywall, paint, framing, patching of existing holes, etc.; union labor, prevailing wage & certified payroll unless noted otherwise; permits are the responsibility of

the end-user; Any special consideration for asbestos and lead paint hazards; any bonds; disposal of material and packaging; damage from negligence, vandalism or Force Majeure; cleaning of site beyond broom clean; cost for special insurance requirements; consumable materials (e.g., batteries); any electrical work including 120v connections and low voltage wiring pulls; and other similar categories of labor and materials not included in the installation quote.

**23. Installation Warranty** dormakaba will provide one (1) year warranty on materials to be free from manufacturer defects and on installation labor performed. Extended warranties are available for an additional cost. dormakaba is not responsible for defects or damages caused by wear and tear, consumable materials (e.g., batteries), vandalism, fires, storms, floods, acts of God, misuse, abuse, or alteration on by any company other than dormakaba. No credit will be provided for any work completed by others during warranty term. dormakaba reserves the right to withhold the performance of warranty work if Buyer payments have become past due. Warranty work will be performed during normal business hours with our standard response times. Any warranty work taking place beyond normal business hours or with expedited response time may be billable. In the event that Buyer, its agents, employees, successors, and/or assigns tampers with, misuses, removes any parts, or adds any parts or equipment, Buyer agrees to indemnify, save and hold harmless dormakaba, its agents, employees, successors, and/or assigns, from any and all liability, damages, or losses, including reasonable attorney's fees, arising out of, or incidental to, the aforementioned conduct. dormakaba warrants that all goods manufactured by dormakaba and all services provided by dormakaba hereunder will be free from defects in workmanship and materials for twelve (12) months from the date of final project invoice to the carrier, unless sold as "With All Faults", "Shop", "As Is", "As They Stand" or other similar designation. Products repaired or replaced under the warranty are warranted only through the remainder of the original warranty period.

April 2023

April 2021





# Hinge Options

## General Information

CB3K Class #s	CB5K Class #s	F/BB 5-Knuckle Class #s	NRP	Security Stud	Shear Resistant Stud	No Hole or Custom Holes	Special Swage	Raised Barrel	Radius Corner	Decorative Tips	Institutional Tips	Hospital Tips	Concealed Electric	Concealed Switch
1900R		F179	▪	▪		▪	▪	▪	▪	▪		▪		
CB1900R	CB179	FBB179	▪	▪		▪	▪	▪	▪	▪		▪	▪	▪
CB1900RA	CB179A	FBB179A	▪			▪	▪		▪	▪		▪		
CB1900RB	CB179B	FBB179B	▪			▪	▪		▪	▪		▪		
CB1901R	CB168	FBB168	▪	▪	▪	▪	▪	▪	▪	▪	▪	▪	▪	▪
CB1907R	CB211	FBB211	Standard											
CB1908R	CB212	FBB212	Standard											
CB1909R	CB213	FBB213	Standard											
1910R		F173	▪			▪				▪		▪		
CB1910R	CB173	FBB173	▪			▪				▪		▪		
CB1911R	CB163	FBB163	▪			▪				▪		▪		
1920R		F167	▪			▪				▪		▪		
CB1920R	CB167	FBB167	▪			▪				▪		▪		
CB1921R	CB138	FBB138	▪			▪				▪		▪		
CB1930R	CB171	FBB171	▪			▪				▪		▪		
CB1931R	CB169	FBB169	▪			▪				▪		▪		
CB1941R	CB264	FBB264	▪			▪				▪		▪		
CB1942R	CB274	FBB274	▪			▪				▪		▪		
CB1946R	CB258	FBB258	▪			▪	▪			▪		▪		
1947R		F248	▪			▪				▪		▪		
CB1947R	CB248	FBB248	▪			▪	▪			▪		▪		
CB1948R	CB268	FBB268	▪			▪	▪			▪		▪		
CB1949R	CB278	FBB278	▪			▪	▪			▪		▪		
CB1951R	CB266	FBB266	▪			▪				▪		▪		
CB1959R	CB269	FBB269	▪			▪				▪		▪		
1960R		F191	▪			▪	▪	▪	▪	▪		▪	▪	▪
CB1960R	CB191	FBB191	▪			▪	▪	▪	▪	▪		▪		
CB1960RA	CB191A	FBB191A	▪			▪	▪		▪	▪		▪		
CB1960RB	CB191B	FBB191B	▪			▪	▪		▪	▪		▪		
CB1961R	CB199	FBB199	▪	▪	▪	▪	▪	▪	▪	▪	▪	▪	▪	▪
CB1967R	CB221	FBB221	Standard											
CB1968R	CB222	FBB222	Standard											
CB1969R	CB223	FBB223	Standard											
CB1970R	CB112	FBB112	▪			▪				▪		▪		
CB1971R	CB113	FBB113	▪			▪				▪		▪		
CB1980R	CB108	FBB108	▪			▪				▪		▪		
CB1981R	CB98	FBB98	▪			▪				▪		▪		
CB1990R	CB110	FBB110	▪			▪				▪		▪		
CB1991R	CB109	FBB109	▪			▪				▪		▪		
2060			Cross Pinned			▪			▪	▪				
BB852			Welded			▪	▪							
BB855			Welded			▪	▪							

▪ = Available

A Slip-In Hinge, Application A

B Slip-In Hinge, Application B

C Reverse spring available

Note: Special options are not available for BB95 hinges. For any other special options, please consult the factory.

Rust resisting base available for all steel based architecture hinges above.

# BEST Finish Symbols and B.H.M.A. Finish Numbers

Specify finish by adding the BEST symbol to the end of the Class Number.

BEST Finish Symbol	General Description	Base Material			
		Steel	Brass	Bronze	Stainless Steel
1D	Black coated	693	693	693	693
2C	Zinc plated	602	—	—	—
3	Bright brass	632	605	—	—
3A	Bright brass, no lacquer, on brass, metal only	—	—	—	—
4	Satin brass	633	606	—	—
5	Satin brass, oxidized	638	609	—	—
9	Bright bronze	637	—	611	—
10	Satin bronze	639	—	612	—
10A*	Satin bronze light, oxidized, lacquered	641	—	614	—
10B*†	Satin bronze dark, oxidized, oil rubbed	640	—	613	—
10BL*	Satin bronze dark, oxidized, clear coated	—	—	—	—
14	Nickel plated, bright	645	618	618	—
15	Nickel plated, satin	646	619	619	—
15A	Antique nickel	647	—	—	—
17A	Nickel plated, imitation half-polished iron oxidized and relieved	648	621	621	—
20*	Statuary bronze	649	—	623	—
20A*	Statuary bronze, dark	650	—	624	—
26	Chromium plated, bright	651	625	625	—
26D	Chromium plated, satin	652	626	626	—
32	Stainless steel metal, bright	—	—	—	629
32D	Stainless steel metal, satin	—	—	—	630
USP	Prime coat, gray	600	—	—	—
PCW	Prime coat, white	—	—	—	—
BC	Black chrome	686	684	684	—
BCD	Black chrome, satin	687	685	685	—
DD	Dark bronze, painted	624E	624E	624E	—
DL	Light bronze, painted	691	691	691	691
DM	Medium bronze, painted	694	694	694	694
F4	Satin brass, blackened, satin relieved, clear coated	—	—	—	—
F8	Antique brass	—	—	—	—
PS	Plain steel—unfinished	—	—	—	—
ST4C	Zinc plated—satin brass tone	604	—	—	—
19	Flat Black, Powder coated	622	622	622	631

\* Finishes 10A/10B/20/20A will be furnished to BEST standards.

† BEST does not recommend the finish on a steel substrate as it is cosmetic in nature and does not afford protection against corrosion.

10B over steel is not covered under warranty. On a steel product we suggest specifying a lacquered 10BL finish.

# Quick Connect Harness

## General Information

	Class & Description	Size	Finish	0.64 in	EDP#	Stock Item
WH-3	3" wire harness terminated at both ends	3"	Ea.	1Ea.	73204166S	3634
WH-6	6" wire harness terminated at both ends	6"	Ea.	1Ea.	73204184	3883
WH-12	12" wire harness terminated at both ends	12"	Ea.	1Ea.	73204167S	4007
WH-26	26" wire harness terminated at both ends	26"	Ea.	1Ea.	73204168S	4402
WH-32	32" wire harness terminated at both ends	32"	Ea.	1Ea.	73204169S	4402
WH-38	38" wire harness terminated at both ends	38"	Ea.	1Ea.	73204170S	4672
WH-44	44" wire harness terminated at both ends	44"	Ea.	1Ea.	73204171S	4796
WH-50	50" wire harness terminated at both ends	50"	Ea.	1Ea.	73204172S	4921
WH-192	192" wire harness terminated at both ends	192"	Ea.	1Ea.	73204181S	10361
WH-3P	3" wire harness terminated at one end and exposed pin heads at the other	3"	Ea.	1Ea.	73204174S	3634
WH-6P	6" wire harness terminated at one end and exposed pin heads at the other	6"	Ea.	1Ea.	73204183S	3634
WH-12P	12" wire harness terminated at one end and exposed pin heads at the other	12"	Ea.	1Ea.	73204175S	4007
WH-26P	26" wire harness terminated at one end and exposed pin heads at the other	26"	Ea.	1Ea.	73204176S	4402
WH-32P	32" wire harness terminated at one end and exposed pin heads at the other	32"	Ea.	1Ea.	73204177S	4402
WH-38P	38" wire harness terminated at one end and exposed pin heads at the other	38"	Ea.	1Ea.	73204178S	4672
WH-44P	44" wire harness terminated at one end and exposed pin heads at the other	44"	Ea.	1Ea.	73204179S	4796
WH-50P	50" wire harness terminated at one end and exposed pin heads at the other	50"	Ea.	1Ea.	73204180S	4921
WH-192P	192" wire harness terminated at one end and exposed pin heads at the other	192"	Ea.	1Ea.	73204181S	10361
WH-6E	6" wire harness terminated at one end and bare leads on the other	6"	Ea.	1Ea.	73204164S	3634

# Pricing Extras

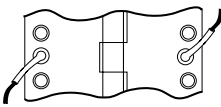
Ordering Prefix	Description	Price	
		Stainless Steel Hinges	All Other Hinges
<b>CE</b>  	<b>Concealed Electric Wires</b> Conduct current from the frame, through the hinge to the door:		
	4 wires 28 AWG (suffix 54)	add 482.06 per hinge	add 413.19 per hinge
	6 wires 28 AWG (suffix 56)	add 602.26 per hinge	add 519.62 per hinge
	6 wires 4 wire 28 AWG, 2 wire 24 AWG (suffix 66)**	add 669.87 per hinge	add 538.40 per hinge
	8 wires (suffix 58)	add 619.79 per hinge	add 550.92 per hinge
	8 wires 2 wire 18 AWG, 6 wire 28 AWG (suffix 18)***	add 638.57 per hinge	add 550.92 per hinge
	10 wires 28 AWG (suffix 10)	add 638.57 per hinge	add 569.71 per hinge
Extra long wires (standard length 6")	add 651.09 per hinge	add 582.23 per hinge	

Class Number	Sizes Available
CB179, FBB179, CB1900R	4-1/2" x 4" (114mm x 102mm)
CB199, FBB199, CB1961R	4-1/2" x 4-1/2" (114mm x 114mm)
CB191, FBB191, CB1960R	5" x 4" (127mm x 102mm)
CB168, FBB168, CB1901R	5" x 4-1/2" (127mm x 114mm)
	5" x 5" (127mm x 127mm)
	6" x 4-1/2" (152mm x 114mm)
	6" x 5" (152mm x 127mm)
	6" x 6" (152mm x 152mm)

- \* Not available in CB191, FBB191, CB1900R, and CB1960R
- \*\* 6 wire (-66) hinge not available in FBB168 and FBB199
- \*\*\* Available in CB168, CB179, CB191, and CB199, 4.5" and 5" only
- 3 knuckle hinges: CB1900R, CB1901R, CB1960R, CB1961R - Specify Hand
- For other sizes consult factory
- Not available in raised barrel, half mortise, half surface, full surface, swing clear, spring hinges





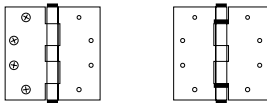

# Pricing Extras

Ordering Prefix	Description	Price	
		Stainless Steel Hinges	All Other Hinges
CS	<p><b>Concealed Switch</b></p> <p>Allows monitoring of the opening. Used to activate alarms or other security equipment</p>		add 327.65 per hinge
Class Number CB179, FBB179, CB1900R CB168, FBB168, CB1901R CB191, FBB191, CB1960R CB199, FBB199, CB1961R	Sizes Available 4-1/2" x 4" (114mm x 102mm) 4-1/2" x 4-1/2" (114mm x 114mm) 5" x 4" (127mm x 102mm) 5" x 4-1/2" (127mm x 114mm) 5" x 5" (127mm x 127mm) 6" x 4-1/2" (152mm x 114mm) 6" x 5" (152mm x 127mm) 6" x 6" (152mm x 152mm)		

Ordering Prefix	Description	Price
SLIP-IN	<p><b>Slip-In Hinges</b></p> <p>• Eliminates Separate drilled and tapped reinforcing plates in either door or frame or both • Available on standard and heavy weight hinges</p> <p>• Specify application A: on leaf slip-in, one leaf mortised - specify one leaf with standard punching and countersinking and one leaf drilled and tapped, specify hand; standard clearance is 3/16" for this application</p>	add 46.44 per hinge
	<p>• Specify application B: both leaves slip-in - specify both leaves drilled and tapped standard clearance is 5/16" for this application</p>	add 46.44 per hinge
	<p>• Specify required clearance between leaves when parallel, if other than standard</p>	



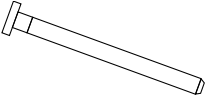

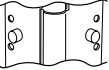
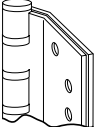
## Pricing Extras

Ordering Prefix		Description	Net Price
BT		<b>Solid Brass Decorative Tips</b> Ball Tip	52.94 per hinge
CT		Crown Tip	73.48 per hinge
ST		Steeple Tip	52.94 per hinge
HT		<b>Hospital Tips</b> <ul style="list-style-type: none"> <li>Hospital tip hinges have knuckle ends which are sloped to prevent the hanging or mounting of objects on them</li> <li>Available on all standard and heavy weight hinges</li> <li>Not available with NRP</li> <li>Not available on spring hinges</li> </ul>	38.90 per hinge
NRP		<b>Non-Removable Pins</b> <ul style="list-style-type: none"> <li>Non-removable pin hinges have a set screw in the barrel accessible only when door is swung open making unauthorized pin removal difficult. Loosing set screw permits pin removal and replacement</li> <li>Available on all standard and heavy weight hinges</li> </ul>	8.58 ea.
STS		<b>Stainless Steel Pins</b> <ul style="list-style-type: none"> <li>For added corrosion resistance when not furnished standard</li> <li>Available on standard and heavy weight hinges</li> </ul>	
		Standard weight 3-1/2", 4" (height-first dimension)	15.08 per hinge
		Heavy weight 4-1/2", 5" (height-first dimension)	20.49 per hinge
		6", 8" (height-first dimension)	26.99 per hinge
		<b>Steel Pins</b> <ul style="list-style-type: none"> <li>Replacement steel pins for architectural grade hinges</li> <li>For standard weight hinges</li> <li>For heavy weight hinges</li> </ul>	2.13 ea. 3.17 ea.
SRS		<b>Shear Resistant Stud</b> <ul style="list-style-type: none"> <li>Studs extend from backs of hinge into frame and door to prevent screws from shearing</li> <li>Available on all heavy weight hinges</li> </ul>	30.21 per hinge
SEC.ST.		<b>Security Stud</b> <ul style="list-style-type: none"> <li>Stud extends from one leaf and engages into a hole in the other leaf making it difficult to slide a door out of a frame even when the pin is removed or the knuckles cut-off</li> <li>Available on all standard and heavy weight hinges</li> </ul>	22.67 per hinge
RB		<b>Raised Barrel Full Mortise Hinges</b> <ul style="list-style-type: none"> <li>Provides clearance so rotating knuckles will not interfere with frame when doors are deeply inset</li> <li>Available on all standard and heavy weight full mortise hinges with unequal leaves</li> </ul>	46.44 per hinge
		With equal leaves	59.44 per hinge
		<ul style="list-style-type: none"> <li>Specify hand; beveled or square edge door; equal or unequal leaves</li> <li>Raised Barrel option not available on swing clear hinges.</li> </ul>	

Certain options may not be applicable to all hinges. Contact factory before ordering.

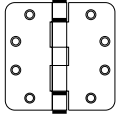
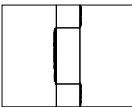
# Pricing Extras

Ordering Prefix	Description	Net Price
RD	 <p><b>Radius Corner Hinges</b></p> <ul style="list-style-type: none"> <li>Available on all standard and heavy weight hinges</li> <li>Specify radius dimension (1/4" or 5/8")</li> <li>Not available on continuous hinges</li> <li>RD option not available on pivot reinforced hinges.</li> </ul>	10.76 per hinge
RS	<p><b>Reverse Spring</b></p> <ul style="list-style-type: none"> <li>Available on 2060R and 2068R hinges only</li> </ul>	price on application
K	<p><b>Rust Resisting Base</b></p> <ul style="list-style-type: none"> <li>Available on all standard and heavy weight hinges</li> <li>Plain bearing</li> </ul>	17.26 per hinge
	<ul style="list-style-type: none"> <li>Ball bearing</li> </ul>	22.67 per hinge
NH	 <p><b>No Hole</b></p> <ul style="list-style-type: none"> <li>For weld-on applications and other special applications</li> <li>Available on standard and heavy weight hinges</li> <li>Not available on continuous hinges</li> <li>Custom Screw Packaging</li> </ul>	price on application
	<p><b>Not Swaged</b></p> <ul style="list-style-type: none"> <li>Back of hinge is flat</li> <li>Available on standard and heavy weight hinges</li> </ul>	price on application
NS	 <p><b>Special Swage</b></p> <ul style="list-style-type: none"> <li>Standard swage is 1/16" clearance when hinge leaves are parallel</li> <li>Available on standard and heavy weight hinges</li> </ul>	price on application
	<p><b>SCREWS</b></p> <p>Custom Screw Packaging Security Screws</p> <ul style="list-style-type: none"> <li>TORX Machine Screws - steel</li> <li>TORX Machine Screws - stainless steel</li> </ul>	1.00 per screw 3.17 per screw

EPT	Electric Power Transfer	Options
Manufacturer	EPT Number	
ABH	PT105	
ABH	PT180	
Abloy	EA280	
Abloy	EA281	
Adam-Rite	4612-1	
Adam-Rite	4612-2	
Precision	EPT-5	
Precision	9512	
Precision	9513	
Securitron	EPT	
Securitron	EPTL	
Von Duprin	EPT2	
Von Duprin	EPT10	
Von Duprin	PNT1	
Sertronic	Sertronic	







\* EPT not available on 663UL, 663HDUL, 664UL, 664HDUL, 665UL or 665HDUL hinges.

Description	Part Number
Flat Head Machine Screw	SCSFHMS
Flat Head Machine Screw & Cap nut	SCSFHMSCN
Flat Head Machine Screw & Aluminum Sleeve Nut	SCSFHMSSN
Flat Head Machine Screw Torx	SCSFHMSTX
Flat Head Thru Bolt and Grommet Nut	SCSFHTBGN
Flat Head Wood Screw	SCSFHWS
Flat Head Wood Screw Torx	SCSFHWSTX

Pricing Extras	
Unlisted Finishes for Architectural Hinges	
CERTAIN OPTIONS MAY NOT BE APPLICABLE TO ALL HINGES. CONTACT FACTORY BEFORE ORDERING	
Finish	Price
PS	Use price of P or 1D*
P, 1D*, DD, 2C	Use price of 10
11, 15A, 17A, 19	Use price of 26 + 10%
26, ST4C, ST4B	Use price of 26D + 20%
PCW	Use price of P + 10%
BC, BCD	Use price of 26 + 35%
9	Use price of 10B + 10%
5, F8, 10A, 10B, 20, 20A	Use price of 26D + 10%
14, 15	Use price of 26D + 15%
3	Use price of 10B
3A	Use price of 3 + 10%
4	Use price of 10 + 10%
10	Use price of 4
All other finishes	Price on application

CERTAIN OPTIONS MAY NOT BE APPLICABLE TO ALL HINGES. CONTACT FACTORY BEFORE ORDERING





	Model	Size	Finish	BHMA	EDP #	Stock Item	List Price	UOM	Order Multiple	Box Qty	Carton Qty	MPG
	<b>BP-1</b> Back Plate	4.5"	P	600	711124661		22.22	Ea.	1 Ea.	10 Ea.	100 Ea.	
		4.5"	26D	652	711124664	✓	23.38	Ea.	1 Ea.	10 Ea.	100 Ea.	
		5"	P	600	711124671		23.45	Ea.	1 Ea.	10 Ea.	100 Ea.	
		5"	26D	652	711124672	✓	24.53	Ea.	1 Ea.	10 Ea.	100 Ea.	
	<b>DLS-1</b> Double Lipped Strike for 1/8" Inset Hung Doors	5.75"	26D	626	711100300	✓	12.17	Ea.	1 Ea.	5 Ea.	50 Ea.	
		5.75"	10	612	711100302		11.424	Ea.	1 Ea.	5 Ea.	50 Ea.	
		5.75"	3	605	711100303		13.412	Ea.	1 Ea.	2 Ea.	50 Ea.	
	<b>DLS-1 BML</b> BML Double Lipped Strike for 1/8" Inset Hung Doors, BEST Mortise Locks	5.75"				MTO		77.31	Ea.	1 Ea.	5 Ea.	50 Ea.
	<b>DLS-2</b> Double Lipped Strike for Center Hung Doors	5.75"	26D	626	711100340	✓	12.17	Ea.	1 Ea.	5 Ea.	50 Ea.	
		5.75"	10	612	711100342		11.424	Ea.	1 Ea.	5 Ea.	50 Ea.	
		5.75"	3	605	711100343		13.675	Ea.	1 Ea.	5 Ea.	50 Ea.	
	<b>DLS-2 BML</b> BML Double Lipped Strike for Center Hung Doors, BEST Mortise Locks	5.75"				MTO		77.31	Ea.	1 Ea.	5 Ea.	50 Ea.
	<b>ES-1</b> Emergency Door Stop	26D		626	711100403	✓	216.28	Ea.	1 Ea.	1 Ea.	30 Ea.	
		10		612	711100405		216.28	Ea.	1 Ea.	1 Ea.	30 Ea.	
		26		625	711100404		265.33	Ea.	1 Ea.	1 Ea.	30 Ea.	
		3		605	711100411		265.33	Ea.	1 Ea.	1 Ea.	30 Ea.	
	<b>HB-1</b> Holdback for ES-1	26D		626	711100409	✓	43.14	Ea.	1 Ea.	1 Ea.	30 Ea.	
	<b>JB-2R</b> Junction Box for CE and CS Hinges	2C		602	711100005	✓	54.69	Ea.	1 Ea.	1 Ea.	30 Ea.	
	<b>DAP-3</b> Double Acting Pivot	P		600	711100459		248.02	Set	1 Set	1 Set	20 Sets	
		10		639	711100458		271.10	Set	1 Set	1 Set	20 Sets	
		26D		652	711100456	✓	276.88	Set	1 Set	1 Set	20 Sets	
		26		651	711100457		311.50	Set	1 Set	1 Set	20 Sets	
		3		632	711100460		311.50	Set	1 Set	1 Set	20 Sets	

## BB95 Standard Weight Olive Knuckle Hinge

	Model	Size	Finish	BHMA	EDP #	Stock Item	List Price	UOM	Order Multiple	Box Qty	Carton Qty	MPG
	<b>BB95LH</b> Forged Brass Standard Weight Olive Knuckle Hinge	6"	26D	626	711040293		344.77	Ea.	1 Ea.	3 Ea.	30 Ea.	
			3	605	711040294	✓	321.20	Ea.	1 Ea.	3 Ea.	30 Ea.	
			10B	613	711040295		385.60	Ea.	1 Ea.	3 Ea.	30 Ea.	
			26	625	711040296		385.60	Ea.	1 Ea.	3 Ea.	30 Ea.	
	<b>BB95RH</b> Forged Brass Standard Weight Olive Knuckle Hinge	6"	26D	626	711040283		344.77	Ea.	1 Ea.	3 Ea.	30 Ea.	
			3	605	711040284		321.20	Ea.	1 Ea.	3 Ea.	30 Ea.	
			10B	613	711040285		385.60	Ea.	1 Ea.	3 Ea.	30 Ea.	
			26	625	711040286		385.60	Ea.	1 Ea.	3 Ea.	30 Ea.	

# Five Knuckle Architectural Hinges

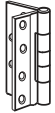
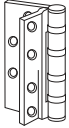
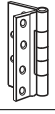
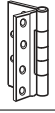
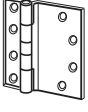
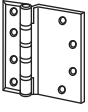
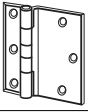
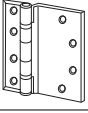
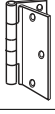
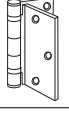
# Hinges & Door Accessories



	Model	Size	Finish	BHMA	EDP #	Stock Item	List Price	UOM	Order Multiple	Box Qty	Carton Qty	MPG	
	<b>CB98</b> Brass, Bronze, or Stainless Steel Half Mortise Heavy Weight Hinge	4.5"	26D	626			498.19	Ea	1Ea.	3 Ea.	30 Ea.	EO	
			32D	630			614.60	Ea	1Ea.	3 Ea.	30 Ea.	EO	
		5"	26D	626				583.81	Ea	1Ea.	3 Ea.	24 Ea.	EO
			32D	630				719.43	Ea	1Ea.	3 Ea.	24 Ea.	EO
			26D	626				804.09	Ea	1Ea.	3 Ea.	24 Ea.	EO
			32D	630				991.62	Ea	1Ea.	3 Ea.	24 Ea.	EO
	<b>FBB98</b> Brass, Bronze, or Stainless Steel Half Mortise Heavy Weight Hinge	4.5"	26D	626			434.71	Ea	1Ea.	3 Ea.	30 Ea.	EO	
			32D	630			536.69	Ea	1Ea.	3 Ea.	30 Ea.	EO	
		5"	26D	626				519.37	Ea	1Ea.	3 Ea.	24 Ea.	EO
			32D	630				640.57	Ea	1Ea.	3 Ea.	24 Ea.	EO
			26D	626				639.58	Ea	1Ea.	3 Ea.	24 Ea.	EO
			32D	630				788.69	Ea	1Ea.	3 Ea.	24 Ea.	EO
	<b>CB108</b> Brass, Bronze, or Stainless Steel Half Mortise Standard Weight Hinge	4.5"	26D	626			423.16	Ea	1Ea.	3 Ea.	30 Ea.	EO	
			32D	630			522.26	Ea	1Ea.	3 Ea.	30 Ea.	EO	
		5"	26D	626				483.76	Ea	1Ea.	3 Ea.	24 Ea.	EO
			32D	630				596.30	Ea	1Ea.	3 Ea.	24 Ea.	EO
	<b>FBB108</b> Brass, Bronze, or Stainless Steel Half Mortise Standard Weight Hinge	4.5"	26D	626			323.16	Ea	1Ea.	3 Ea.	30 Ea.	EO	
			32D	630			399.14	Ea	1Ea.	3 Ea.	30 Ea.	EO	
		5"	26D	626				383.75	Ea	1Ea.	3 Ea.	24 Ea.	EO
			32D	630				473.20	Ea	1Ea.	3 Ea.	24 Ea.	EO
	<b>CB109</b> Brass, Bronze, or Stainless Steel Full Surface Heavy Weight Hinge	4.5"	26D	626			483.76	Ea	1Ea.	3 Ea.	30 Ea.	EO	
			32D	630			596.30	Ea	1Ea.	3 Ea.	30 Ea.	EO	
		5"	26D	626				567.44	Ea	1Ea.	3 Ea.	24 Ea.	EO
			32D	630				699.24	Ea	1Ea.	3 Ea.	24 Ea.	EO
			26D	626				804.09	Ea	1Ea.	3 Ea.	24 Ea.	EO
			32D	630				991.62	Ea	1Ea.	3 Ea.	24 Ea.	EO
	<b>FBB109</b> Brass, Bronze, or Stainless Steel Full Surface Heavy Weight Hinge	4.5"	26D	626			434.71	Ea	1Ea.	3 Ea.	30 Ea.	EO	
			32D	630			536.69	Ea	1Ea.	3 Ea.	30 Ea.	EO	
		5"	26D	626				549.19	Ea	1Ea.	3 Ea.	24 Ea.	EO
			32D	630				677.09	Ea	1Ea.	3 Ea.	24 Ea.	EO
			26D	626				639.58	Ea	1Ea.	3 Ea.	24 Ea.	EO
			32D	630				788.69	Ea	1Ea.	3 Ea.	24 Ea.	EO
	<b>CB110</b> Brass, Bronze, or Stainless Steel Full Surface Standard Weight Hinge	4.5"	26D	626			423.16	Ea	1Ea.	3 Ea.	30 Ea.	EO	
			32D	630			522.26	Ea	1Ea.	3 Ea.	30 Ea.	EO	
		5"	26D	626				483.76	Ea	1Ea.	3 Ea.	24 Ea.	EO
			32D	630				596.30	Ea	1Ea.	3 Ea.	24 Ea.	EO
	<b>FBB110</b> Brass, Bronze, or Stainless Steel Full Surface Standard Weight Hinge	4.5"	26D	626			370.28	Ea	1Ea.	3 Ea.	30 Ea.	EO	
			32D	630			456.85	Ea	1Ea.	3 Ea.	30 Ea.	EO	
		5"	26D	626				446.25	Ea	1Ea.	3 Ea.	24 Ea.	EO
			32D	630				551.11	Ea	1Ea.	3 Ea.	24 Ea.	EO
	<b>CB112</b> Brass, Bronze, or Stainless Steel Half Surface Standard Weight Hinge	4.5"	26D	626			512.62	Ea	1Ea.	3 Ea.	30 Ea.	EO	
			32D	630			614.60	Ea	1Ea.	3 Ea.	30 Ea.	EO	
		5"	26D	626				600.17	Ea	1Ea.	3 Ea.	24 Ea.	EO
			32D	630				719.43	Ea	1Ea.	3 Ea.	24 Ea.	EO
	<b>FBB112</b> Brass, Bronze, or Stainless Steel Half Surface Standard Weight Hinge	4.5"	26D	626			370.28	Ea	1Ea.	3 Ea.	30 Ea.	EO	
			32D	630			456.85	Ea	1Ea.	3 Ea.	30 Ea.	EO	
		5"	26D	626				411.62	Ea	1Ea.	3 Ea.	24 Ea.	EO
			32D	630				507.83	Ea	1Ea.	3 Ea.	24 Ea.	EO
	<b>CB113</b> Brass, Bronze, or Stainless Steel Half Surface Heavy Weight Hinge	4.5"	26D	626			498.19	Ea	1Ea.	3 Ea.	30 Ea.	EO	
			32D	630			670.38	Ea	1Ea.	3 Ea.	30 Ea.	EO	
		5"	26D	626				583.81	Ea	1Ea.	3 Ea.	24 Ea.	EO
			32D	630				784.85	Ea	1Ea.	3 Ea.	24 Ea.	EO
			26D	626				778.12	Ea	1Ea.	3 Ea.	24 Ea.	EO
			32D	630				933.94	Ea	1Ea.	3 Ea.	24 Ea.	EO

All prices are for items furnished with screws (as specified in catalog) unless otherwise stated in price list.  
 \* To price other finishes on architectural items – See pricing extras.

\*\* For conversion pins and decorative tips – See Miscellaneous Architectural Parts.  
 (X) Item must be ordered in these increments.

# Five Knuckle Architectural Hinges (cont.)

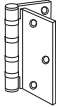
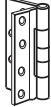
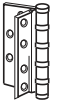
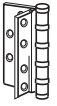
# Hinges & Door Accessories

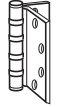
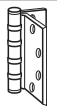
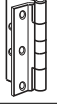
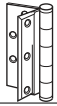
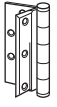
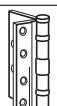

	Model	Size	Finish	BHMA	EDP #	Stock Item	List Price	UOM	Order Multiple	Box Qty	Carton Qty	MPG		
	<b>FBB113</b> Brass, Bronze, or Stainless Steel Half Surface Heavy Weight Hinge	4.5"	26D	626			434.71	Ea	1Ea	3 Ea	30 Ea	EO		
			32D	630			536.69	Ea	1Ea	3 Ea	30 Ea	EO		
		5"	26D	626				549.19	Ea	1Ea	3 Ea	24 Ea	EO	
				32D	630			677.09	Ea	1Ea	3 Ea	24 Ea	EO	
			6"	26D	626				693.46	Ea	1Ea	3 Ea	24 Ea	EO
				32D	630				856.03	Ea	1Ea	3 Ea	24 Ea	EO
	<b>CB138</b> Steel Half Mortise Heavy Weight Hinge	4.5"	26D	652			428.94	Ea	1Ea	3 Ea	30 Ea	EO		
			P	600			343.35	Ea	1Ea	3 Ea	30 Ea	EO		
		5"	26D	652				530.92	Ea	1Ea	3 Ea	24 Ea	EO	
			P	600				425.11	Ea	1Ea	3 Ea	24 Ea	EO	
		6"	26D	652				556.89	Ea	1Ea	3 Ea	24 Ea	EO	
			P	600				446.25	Ea	1Ea	3 Ea	24 Ea	EO	
	<b>FBB138</b> Steel Half Mortise Heavy Weight Hinge	4.5"	P	600	71060263		220.23	Ea	1Ea	3 Ea	30 Ea	EO		
			26D	652	71060265		262.56	Ea	1Ea	3 Ea	30 Ea	EO		
		5"	P	600	71062911			298.14	Ea	1Ea	3 Ea	24 Ea	EO	
			26D	652	71062907			298.14	Ea	1Ea	3 Ea	24 Ea	EO	
		6"	26D	652	71063024			359.68	Ea	1Ea	3 Ea	24 Ea	EO	
	<b>FBB138NRP</b> Steel Half Mortise Heavy Weight Hinge w/ Non-Removable Pin	4.5"	P	600	71060262		218.66	Ea	1Ea	3 Ea	30 Ea	EO		
		4.5"	26D	652	71060266		271.14	Ea	1Ea	3 Ea	30 Ea	EO		
	<b>CB163</b> Steel Half Surface Heavy Weight Hinge	4.5"	P	600			134.76	Ea	1Ea	3 Ea	30 Ea	EO		
			26D	652			146.07	Ea	1Ea	3 Ea	30 Ea	EO		
		5"	P	600				152.42	Ea	1Ea	3 Ea	24 Ea	EO	
			26D	652				165.82	Ea	1Ea	3 Ea	24 Ea	EO	
		6"	P	600				173.59	Ea	1Ea	3 Ea	24 Ea	EO	
			26D	652				188.41	Ea	1Ea	3 Ea	24 Ea	EO	
	<b>FBB163</b> Steel Half Surface Heavy Weight Hinge	4.5"	P	600	71061983		220.23	Ea	1Ea	3 Ea	30 Ea	EO		
			26D	652	71061984		241.37	Ea	1Ea	3 Ea	30 Ea	EO		
		5"	P	600	71064343			251.97	Ea	1Ea	3 Ea	24 Ea	EO	
			26D	652	71064344	✓		274.10	Ea	1Ea	3 Ea	24 Ea	EO	
		6"	P	600	71064384			327.00	Ea	1Ea	3 Ea	24 Ea	EO	
			26D	652	71064387			369.32	Ea	1Ea	3 Ea	24 Ea	EO	
	<b>FBB163NRP</b> Steel Half Surface Heavy Weight Hinge w/ Non-Removable Pin	4.5"	P	600	71061981		228.81	Ea	1Ea	3 Ea	30 Ea	EO		
		4.5"	26D	652	71061994		249.95	Ea	1Ea	3 Ea	30 Ea	EO		
	<b>CB167</b> Steel Half Mortise Standard Weight Hinge	4.5"	P	600			60.79	Ea	1Ea	3 Ea	30 Ea	EO		
			26D	652			73.37	Ea	1Ea	3 Ea	30 Ea	EO		
		5"	P	600				86.64	Ea	1Ea	3 Ea	24 Ea	EO	
	<b>F167</b> Steel Half Mortise Standard Weight Hinge	4.5"	P	600	71050126		53.84	Ea	1Ea	3 Ea	30 Ea	EO		
			4.5"	26D	652	71050125		70.18	Ea	1Ea	3 Ea	30 Ea	EO	
	<b>F167NRP</b> Steel Half Mortise Standard Weight Hinge w/ Non- Removable Pin	4.5"	P	600	71050127		62.42	Ea	1Ea	3 Ea	30 Ea	EO		
		4.5"	26D	652	71062139		78.76	Ea	1Ea	3 Ea	30 Ea	EO		
	<b>FBB167</b> Steel Half Mortise Standard Weight Hinge	4.5"	P	600	71062143	✓	98.08	Ea	1Ea	3 Ea	30 Ea	EO		
		4.5"	26D	652	71062145	✓	118.28	Ea	1Ea	3 Ea	30 Ea	EO		
		5"	P	600	71060353			137.49	Ea	1Ea	3 Ea	24 Ea	EO	
		5"	26D	652	71060363			150.02	Ea	1Ea	3 Ea	24 Ea	EO	

All prices are for items furnished with screws (as specified in catalog) unless otherwise stated in price list.  
\* To price other finishes on architectural items – See pricing extras.

\*\* For conversion pins and decorative tips – See Miscellaneous Architectural Parts.  
(X) Item must be ordered in these increments.

# Five Knuckle Architectural Hinges (cont.)

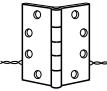
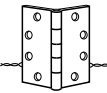
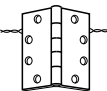
# Hinges & Door Accessories





	Model	Size	Finish	BHMA	EDP #	Stock Item	List Price	UOM	Order Multiple	Box Qty	Carton Qty	MPG		
	<b>FBB167NRP</b> Steel Half Mortise Standard Weight Hinge w/ Non-Removable Pin	4.5"	P	600	711064491		106.66	Ea	1Ea.	3 Ea.	30 Ea.	EO		
		4.5"	26D	652	711064490		126.86	Ea	1Ea.	3 Ea.	30 Ea.	EO		
	<b>CECB168-12C</b> 12 Conductor Electrified Hinge w/ Quick Connect	4.5"X4.5"	3	632	711450106		850.97	Ea	1Ea.	1EA	5 EA	D4		
			10B	640	711450104		728.38	Ea	1Ea.	1EA	5 EA	D4		
			26D	652	711450097		709.14	Ea	1Ea.	1EA	5 EA	D4		
		5" X 4.5"	26D	652	711450098		723.57		1Ea.	1EA	5 EA	D4		
			5" x 5"	10B	640	711450077		868.28	Ea	1Ea.	1EA	5 EA	D4	
		26D		652	711450078		723.57	Ea	1Ea.	1EA	5 EA	D4		
		3		632	711450079		868.28	Ea	1Ea.	1EA	5 EA	D4		
		4	633	711450080		868.28	Ea	1Ea.	1EA	5 EA	D4			
	<b>CECB168-18</b> Steel Full Mortise Heavy Weight Concealed Conductor Hinge Spec. 8- wire	4.5"x4.5"	26D	652	711839233	✓	690.36	Ea	1Ea.	1Ea.	5 Ea.	D4		
		5"x4.5"	26D	652	711839241	✓	704.79	Ea	1Ea.	1Ea.	5 Ea.	D4		
	<b>CECB168-54</b> Steel Full Mortise Heavy Weight Concealed Conductor Hinge 4- wire	4.5"x4"	26D	652	711451572		552.63	Ea	1Ea.	1Ea.	5	D4		
		4.5"x4.5"	26D	652	711451570		552.63	Ea	1Ea.	1Ea.	5 Ea.	D4		
		5"x4.5"	26D	652	711451573		567.06	Ea	1Ea.	1Ea.	5	D4		
	<b>CECB168-66</b> Steel Full Mortise Heavy Weight Concealed Conductor Hinge Spec. 6- wire	4.5"x4.5"	10	639	711450029		668.23	Ea	1Ea.	1Ea.	5	D4		
			10A	641	711450030		677.84	Ea	1Ea.	1Ea.	5	D4		
			26	651	711450032		697.08	Ea	1Ea.	1Ea.	5	D4		
		5"x4.5"	26D	652	711450028		697.08	Ea	1Ea.	1Ea.	5	D4		
			3	632	711450031		697.08	Ea	1Ea.	1Ea.	5	D4		
			26D	652	711450033		683.61	Ea	1Ea.	1Ea.	5	D4		
	<b>CB168</b> Steel Full Mortise Heavy Weight Hinge	4.5"x4"	26D	652	711451346	✓	139.44	Ea	1Ea.	3 Ea.	30 Ea.	EO		
			15	646	711451345		146.15	Ea	1Ea.	3 Ea.	30 Ea.	EO		
		4.5"x4.5"	P	600	711451672		125.01	Ea	1Ea.	3 Ea.	30 Ea.	EO		
			10	639	711451673		129.82	Ea	1Ea.	3 Ea.	30 Ea.	EO		
			26D	652	711451676	✓	139.44	Ea	1Ea.	3 Ea.	30 Ea.	EO		
			26	651	711451675		158.68	Ea	1Ea.	3 Ea.	30 Ea.	EO		
			10A	641	711451680		158.68	Ea	1Ea.	3 Ea.	30 Ea.	EO		
			3	632	711451678		158.68	Ea	1Ea.	3 Ea.	30 Ea.	EO		
		5"x4.5"	P	600	711451742		145.21	Ea	1Ea.	3 Ea.	24 Ea.	EO		
			26D	652	711451746	✓	153.86	Ea	1Ea.	3 Ea.	24 Ea.	EO		
			10A	641	711451749		180.78	Ea	1Ea.	3 Ea.	24 Ea.	EO		
			26	651			180.78	Ea	1Ea.	3 Ea.	24 Ea.	EO		
			10	639	711451743		149.04	Ea	1Ea.	3 Ea.	24 Ea.	EO		
			5"x5"	P	600	711451812		145.21	Ea	1Ea.	3 Ea.	24 Ea.	EO	
			<b>CB168NRP</b> Steel Full Mortise Heavy Weight Hinge w/ Non-Removable Pin	4.5"x4"	26D	652	711451329	✓	148.02	Ea	1Ea.	3 Ea.	30 Ea.	EO
					15	646	711451348		154.73	Ea	1Ea.	3 Ea.	15 Ea.	EO
				4.5"x4.5"	P	600	711451682		133.59	Ea	1Ea.	3 Ea.	30 Ea.	EO
					10	639	711451683		138.40	Ea	1Ea.	3 Ea.	30 Ea.	EO
					26D	652	711451684	✓	148.02	Ea	1Ea.	3 Ea.	30 Ea.	EO
					3	632	711451687		167.26	Ea	1Ea.	3 Ea.	30 Ea.	EO
10A	641				711451685		167.26	Ea	1Ea.	3 Ea.	30 Ea.	EO		
26	651						167.26	Ea	1Ea.	3 Ea.	30 Ea.	EO		
5"x4.5"	P			600	711451769		153.79	Ea	1Ea.	3 Ea.	24 Ea.	EO		
	26D			652	711451775	✓	162.44	Ea	1Ea.	3 Ea.	24 Ea.	EO		
	10			639			157.62	Ea	1Ea.	3 Ea.	24 Ea.	EO		
	26			651			189.36	Ea	1Ea.	3 Ea.	24 Ea.	EO		
5"x5"	26D			652	711451828		162.44	Ea	1Ea.	3 Ea.	24 Ea.	EO		
	P			600	711451811		153.79	Ea	1Ea.	3 Ea.	24 Ea.	EO		
	10	639			157.62	Ea	1Ea.	3 Ea.	24 Ea.	EO				
	10A	641			187.80	Ea	1Ea.	3 Ea.	24 Ea.	EO				

All prices are for items furnished with screws (as specified in catalog) unless otherwise stated in price list.  
 \* To price other finishes on architectural items – See pricing extras.

\*\* For conversion pins and decorative tips – See Miscellaneous Architectural Parts.  
 (X) Item must be ordered in these increments.

# Five Knuckle Architectural Hinges (cont.)

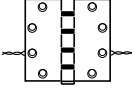



# Hinges & Door Accessories

	Model	Size	Finish	BHMA	EDP #	Stock Item	List Price	UOM	Order Multiple	Box Qty	Carton Qty	MPG	
	<b>IHTCB168 N/SRS</b>	4.5"x4.5"	P	600	711925501		237.55	Ea	1Ea	3 Ea.	36 Ea.	EO	
	Steel Full Mortise Heavy Weight Institutional Hospital Tip Hinge	5"x4.5"	P	600	711925509		309.68	Ea	1Ea	3 Ea.	24 Ea.	EO	
	<b>IHTCB168 SRS</b>	4.5"x4.5"	P	600			194.12					EO	
	Steel Full Mortise Heavy Weight Institutional Hospital Tip Hinge and Sheer Resistant Stud	5"x4.5"	P	600			214.32					EO	
	<b>CEFB168-54</b>	4.5"x4.5"	26D	652	711061570	✓	533.37	Ea	1Ea	1Ea.	5 Ea.	D4	
	Steel Full Mortise Heavy Weight Concealed Conductor Hinge 4- wire												
	<b>FBB168</b>	4.5"x4"	19	631			108.12	Ea	1Ea	3 Ea.	30 Ea.	EO	
	Steel Full Mortise Heavy Weight Hinge	26D	652	711061346	✓		120.18	Ea	1Ea.	3 Ea.	30 Ea.	EO	
		15	646	711061345			136.55	Ea	1Ea.	3 Ea.	30 Ea.	EO	
		4.5"x4.5"	P	600	711061672	✓		113.47	Ea	1Ea.	3 Ea.	30 Ea.	EO
		19	631				108.12	Ea	1Ea.	3 Ea.	30 Ea.	EO	
		10	639	711061673	✓		113.47	Ea	1Ea.	3 Ea.	30 Ea.	EO	
		26D	652	711061676	✓		120.18	Ea	1Ea.	3 Ea.	30 Ea.	EO	
		4	633	711061679	✓		113.47	Ea	1Ea.	3 Ea.	30 Ea.	EO	
		26	651	711061675	✓		135.59	Ea	1Ea.	3 Ea.	30 Ea.	EO	
		10B	640	711061677	✓		135.59	Ea	1Ea.	3 Ea.	30 Ea.	EO	
		3	632	711061678	✓		135.59	Ea	1Ea.	3 Ea.	30 Ea.	EO	
		10A	641	711061680	✓		135.59	Ea	1Ea.	3 Ea.	30 Ea.	EO	
		15	646	711061352			136.55	Ea	1Ea.	3 Ea.	30 Ea.	EO	
		10BL	-	711061728			144.25	Ea	1Ea.	3 Ea.	30 Ea.	EO	
		5"x4"	26D	652	711061380	✓		131.72	Ea	1Ea.	3 Ea.	24 Ea.	EO
		5"x4.5"	P	600	711061742			124.05	Ea	1Ea.	3 Ea.	24 Ea.	EO
		19	631				118.50	Ea	1Ea.	3 Ea.	24 Ea.	EO	
		10	639	711061743	✓		127.89	Ea	1Ea.	3 Ea.	24 Ea.	EO	
		26D	652	711061746	✓		131.72	Ea	1Ea.	3 Ea.	24 Ea.	EO	
		4	633	711061753			127.89	Ea	1Ea.	3 Ea.	24 Ea.	EO	
		10A	641	711061749			169.24	Ea	1Ea.	3 Ea.	24 Ea.	EO	
		26	651	711061747			169.24	Ea	1Ea.	3 Ea.	24 Ea.	EO	
		3	632	711061752			169.24	Ea	1Ea.	3 Ea.	24 Ea.	EO	
		5"x5"	P	600	711061812			124.05	Ea	1Ea.	3 Ea.	24 Ea.	EO
		19	631				118.50	Ea	1Ea.	3 Ea.	24 Ea.	EO	
		26D	652	711061816	✓		131.72	Ea	1Ea.	3 Ea.	24 Ea.	EO	
		10	639	711061813			127.89	Ea	1Ea.	3 Ea.	24 Ea.	EO	
	10A	641	711061818			168.29	Ea	1Ea.	3 Ea.	24 Ea.	EO		
	3	632	711061820	✓		169.24	Ea	1Ea.	3 Ea.	24 Ea.	EO		
	6"x5"	P	600	711064976			247.15	Ea	1Ea.	3 Ea.	24 Ea.	EO	
	26D	652	711064979			275.06	Ea	1Ea.	3 Ea.	24 Ea.	EO		
	6"x6"	P	600	711061832			253.90	Ea	1Ea.	3 Ea.	24 Ea.	EO	
	26D	652	711061835			275.06	Ea	1Ea.	3 Ea.	24 Ea.	EO		
	<b>OKSFBB168</b>	4.5"x4.5"	26D	652	7265996		86.79	Ea	30 Ea.	3 Ea.	30 Ea.	EO	
	By LOCKT Steel Adjustable Full Mortise Heavy Weight Hinge												

All prices are for items furnished with screws (as specified in catalog) unless otherwise stated in price list.  
 \* To price other finishes on architectural items – See pricing extras.



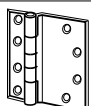
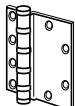

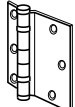
\*\* For conversion pins and decorative tips – See Miscellaneous Architectural Parts.  
 (X) Item must be ordered in these increments.

# Five Knuckle Architectural Hinges (cont.)

Model	Size	Finish	BHMA	EDP #	Stock Item	List Price	UOM	Order Multiple	Box Qty	Carton Qty	MPG
 <b>FBB168NRP</b> Steel Full Mortise Heavy Weight Hinge w/ Non-Removable Pin	4.5"x4"	19	631			118.50	Ea	1Ea	3 Ea	30 Ea	EO
		26D	652	71061349		128.76	Ea	1Ea	3 Ea	15 Ea	EO
		15	646	71061348		145.13	Ea	1Ea	3 Ea	30 Ea	EO
	4.5"x4.5"	P	600	71061682	✓	122.05	Ea	1Ea	3 Ea	30 Ea	EO
		19	631			118.50	Ea	1Ea	3 Ea	30 Ea	EO
		10	639	71061683	✓	122.05	Ea	1Ea	3 Ea	30 Ea	EO
		26D	652	71061684	✓	128.76	Ea	1Ea	3 Ea	30 Ea	EO
		4	633	71061671		122.05	Ea	1Ea	3 Ea	30 Ea	EO
		26	651	71061681		144.17	Ea	1Ea	3 Ea	30 Ea	EO
		3	632	71061687		144.17	Ea	1Ea	3 Ea	30 Ea	EO
		10A	641	71061685		144.17	Ea	1Ea	3 Ea	30 Ea	EO
	5"x4.5"	P	600	71061769		132.63	Ea	1Ea	3 Ea	24 Ea	EO
		19	631			128.02	Ea	1Ea	3 Ea	24 Ea	EO
		10	639	71061741		136.47	Ea	1Ea	3 Ea	24 Ea	EO
		26D	652	71061775	✓	140.30	Ea	1Ea	3 Ea	24 Ea	EO
		4	633	71061738		136.47	Ea	1Ea	3 Ea	24 Ea	EO
		3	632	71061739		177.82	Ea	1Ea	3 Ea	24 Ea	EO
		26	651	71061740		177.82	Ea	1Ea	3 Ea	24 Ea	EO
	5"x5"	P	600	71061811	✓	132.63	Ea	1Ea	3 Ea	24 Ea	EO
		19	631			128.02	Ea	1Ea	3 Ea	24 Ea	EO
	26D	652	71061828		140.30	Ea	1Ea	3 Ea	24 Ea	EO	
	10	639	71061800		136.47	Ea	1Ea	3 Ea	24 Ea	EO	
	10A	641	71061801		176.87	Ea	1Ea	3 Ea	24 Ea	EO	
	3	632	71061802		177.82	Ea	1Ea	3 Ea	24 Ea	EO	
 <b>QKSFBB168NRP</b> By LOCKT Steel Adjustable Full Mortise Heavy Weight Hinge w/ Non-Removable Pin	4.5"x4.5"	26D	652	7265997		95.37	Ea	30 Ea	3 Ea	30 Ea	EO
 <b>FBB168WT</b> Wide Throw Steel Full Mortise Heavy Weight Hinge	4.5"x5"	26D	652	71061692		271.22	Ea	1Ea	3 Ea	24 Ea	EO
	4.5"x6"	26D	652	71061699		263.52	Ea	1Ea	3 Ea	24 Ea	EO
	4.5"x7"	26D	652	71061706		297.19	Ea	1Ea	3 Ea	24 Ea	EO
	4.5"x8"	26D	652	71061713		297.19	Ea	1Ea	3 Ea	24 Ea	EO
	5"x7"	26D	652	71061844		295.26	Ea	1Ea	3 Ea	12 Ea	EO
	5"x8"	26D	652	71061882		295.26	Ea	1Ea	3 Ea	12 Ea	EO
 <b>CB169</b> Steel Full Surface Heavy Weight Hinge	4.5"	P	600			349.13	Ea	1Ea	3 Ea	30 Ea	EO
		26D	652			428.94	Ea	1Ea	3 Ea	30 Ea	EO
	5"	P	600			446.25	Ea	1Ea	3 Ea	30 Ea	EO
		26D	652			530.92	Ea	1Ea	3 Ea	30 Ea	EO
	6"	P	600			468.39	Ea	1Ea	3 Ea	30 Ea	EO
		26D	652			556.89	Ea	1Ea	3 Ea	30 Ea	EO
 <b>FBB169</b> Steel Full Surface Heavy Weight Hinge	4.5"	P	600	71062212		220.23	Ea	1Ea	3 Ea	30 Ea	EO
		26D	652	71062215		262.56	Ea	1Ea	3 Ea	30 Ea	EO
	5"	P	600	71062302		251.97	Ea	1Ea	3 Ea	24 Ea	EO
		26D	652	71062220		306.80	Ea	1Ea	3 Ea	24 Ea	EO
	6"	P	600	71061875		327.00	Ea	1Ea	3 Ea	24 Ea	EO
		26D	652	71061878		369.32	Ea	1Ea	3 Ea	24 Ea	EO
 <b>FBB169NRP</b> Steel Full Surface Heavy Weight Hinge w/ Non-Removable Pin	4.5"	P	600	71062211		228.81	Ea	1Ea	3 Ea	30 Ea	EO
	5"	P	600	71062301		260.55	Ea	1Ea	3 Ea	24 Ea	EO
 <b>CB171</b> Steel Full Surface Standard Weight Hinge	4.5"	P	600	71452483		108.64	Ea	1Ea	3 Ea	30 Ea	EO
		26D	652			124.86	Ea	1Ea	3 Ea	30 Ea	EO
	5"	P	600			148.11	Ea	1Ea	3 Ea	24 Ea	EO
		26D	652			164.02	Ea	1Ea	3 Ea	24 Ea	EO
 <b>FBB171</b> Steel Full Surface Standard Weight Hinge	4.5"	P	600	71062483		100.97	Ea	1Ea	3 Ea	30 Ea	EO
		26D	652	71062482		134.61	Ea	1Ea	3 Ea	30 Ea	EO
	5"	P	600	71062512		137.49	Ea	1Ea	3 Ea	24 Ea	EO
		26D	652	71062515		176.95	Ea	1Ea	3 Ea	24 Ea	EO

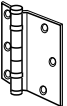
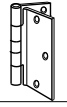
# Five Knuckle Architectural Hinges (cont.)

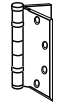
## Hinges & Door Accessories



	Model	Size	Finish	BHMA	EDP #	Stock Item	List Price	UOM	Order Multiple	Box Qty	Carton Qty	MPG
	<b>FBB171NRP</b> Steel Full Surface Standard Weight Hinge w/ Non- Removable Pin	4.5"	P	600	711065510		109.55	Ea.	1Ea.	3 Ea.	30 Ea.	EO
		4.5"	26D	652	711062481		143.19	Ea.	1Ea.	3 Ea.	30 Ea.	EO
	<b>CB173</b> Steel Half Surface Standard Weight Hinge	4"	P	600			86.87	Ea.	1Ea.	3 Ea.	48 Ea.	EO
		4.5"	26D	652	711452726		122.12	Ea.	1Ea.	3 Ea.	30 Ea.	EO
			P	600	711452722		94.21	Ea.	1Ea.	3 Ea.	30 Ea.	EO
	<b>F173</b> Steel Half Surface Standard Weight Hinge	4.5"	P	600	711050132	✓	49.03	Ea.	1Ea.	3 Ea.	30 Ea.	EO
		4.5"	26D	652	711050134		64.41	Ea.	1Ea.	3 Ea.	30 Ea.	EO
	<b>F173NRP</b> Steel Half Surface Standard Weight Hinge w/ Non- Removable Pin	4.5"	P	600	711050131		57.61	Ea.	1Ea.	3 Ea.	30 Ea.	EO
		4.5"	26D	652	711050145		72.99	Ea.	1Ea.	3 Ea.	30 Ea.	EO
	<b>FBB173</b> Steel Half Surface Standard Weight Hinge	4"	P	600	711062682		80.77	Ea.	1Ea.	3 Ea.	48 Ea.	EO
		4.5"	P	600	711062722	✓	92.31	Ea.	1Ea.	3 Ea.	30 Ea.	EO
		4.5"	26D	652	711062726	✓	108.64	Ea.	1Ea.	3 Ea.	30 Ea.	EO
		4.5"	10	639	711062723		99.04	Ea.	1Ea.	3 Ea.	30 Ea.	EO
		5"	P	600	711062746		137.49	Ea.	1Ea.	3 Ea.	24 Ea.	EO
		5"	26D	652	711062747	✓	157.69	Ea.	1Ea.	3 Ea.	24 Ea.	EO
	<b>FBB173NRP</b> Steel Half Surface Standard Weight Hinge w/ Non- Removable Pin	4.5"	P	600	711062734		100.89	Ea.	1Ea.	3 Ea.	30 Ea.	EO
		4.5"	26D	652	711062735		117.22	Ea.	1Ea.	3 Ea.	30 Ea.	EO
		5"	P	600	711062743		146.07	Ea.	1Ea.	3 Ea.	24 Ea.	EO

All prices are for items furnished with screws (as specified in catalog) unless otherwise stated in price list.  
 \* To price other finishes on architectural items – See pricing extras.

\*\* For conversion pins and decorative tips – See Miscellaneous Architectural Parts.  
 (X) Item must be ordered in these increments.



# Five Knuckle Architectural Hinges (cont.)





Model	Size	Finish	BHMA	EDP #	Stock Item	List Price	UOM	Order Multiple	Box Qty	Carton Qty	MPG
 <b>CB179</b> Steel Full Mortise Standard Weight Hinge	3.5"x3.5"	4	633	71458100		47.10	Ea	1Ea.	3 Ea.	90 Ea.	EO
		3	632	71458099		61.53	Ea	1Ea.	3 Ea.	90 Ea.	EO
		26D	652	71458096	✓	47.10	Ea	1Ea.	3 Ea.	90 Ea.	EO
		26	651	71458095		61.53	Ea	1Ea.	3 Ea.	90 Ea.	EO
	4"x4"	26D	652	71458261	✓	51.91	Ea	1Ea.	3 Ea.	48 Ea.	EO
		3	632	71458277		66.34	Ea	1Ea.	3 Ea.	48 Ea.	EO
		F8		71457283		75.00	Ea	1Ea.	3 Ea.	48 Ea.	EO
		10A	641	71458202		55.76	Ea	1Ea.	3 Ea.	48 Ea.	EO
		10	639	71458201		41.33	Ea	1Ea.	3 Ea.	48 Ea.	EO
		P	600	71457282		46.14	Ea	1Ea.	3 Ea.	48 Ea.	EO
		4.5"x4"	P	600	71453412		49.98	Ea	1Ea.	3 Ea.	48 Ea.
	4.5"x4.5"	4	633	71453437		49.98	Ea	1Ea.	3 Ea.	48 Ea.	EO
		10	639	71453413		51.91	Ea	1Ea.	3 Ea.	48 Ea.	EO
		26D	652	71453416	✓	53.84	Ea	1Ea.	3 Ea.	48 Ea.	EO
		3	632	71453419		72.11	Ea	1Ea.	3 Ea.	48 Ea.	EO
		10A	641	71453429		64.41	Ea	1Ea.	3 Ea.	48 Ea.	EO
		26	651	71453415		64.41	Ea	1Ea.	3 Ea.	48 Ea.	EO
		15	646	71453431		59.58	Ea	1Ea.	3 Ea.	48 Ea.	EO
		P	600	71458431	✓	49.98	Ea	1Ea.	3 Ea.	48 Ea.	EO
		4	633	71458784		49.98	Ea	1Ea.	3 Ea.	48 Ea.	EO
10		639	71458381		51.91	Ea	1Ea.	3 Ea.	48 Ea.	EO	
5"x4"	26D	652	71458441	✓	53.84	Ea	1Ea.	3 Ea.	48 Ea.	EO	
	10A	641	71458383	✓	74.01	Ea	1Ea.	3 Ea.	48 Ea.	EO	
	3	632	71458436	✓	72.11	Ea	1Ea.	3 Ea.	48 Ea.	EO	
	26	651	71458438		64.41	Ea	1Ea.	3 Ea.	48 Ea.	EO	
	10B	640	71457583	✓	64.41	Ea	1Ea.	3 Ea.	48 Ea.	EO	
	10BL	-	71457584		64.41	Ea	1Ea.	3 Ea.	48 Ea.	EO	
	P	600			79.53	Ea	1Ea.	3 Ea.	30 Ea.	EO	
	26D	652	71457885		81.73	Ea	1Ea.	3 Ea.	30 Ea.	EO	
5"x4.5"	P	600	71453818		81.73	Ea	1Ea.	3 Ea.	30 Ea.	EO	
	26D	652	71453823	✓	81.73	Ea	1Ea.	3 Ea.	30 Ea.	EO	
5"x5"	P	600	71458618		81.73	Ea	1Ea.	3 Ea.	30 Ea.	EO	
	26D	652	71458624		81.73	Ea	1Ea.	3 Ea.	30 Ea.	EO	
	4	633			84.46	Ea	1Ea.	3 Ea.	30 Ea.	EO	
	10A	641			105.24	Ea	1Ea.	3 Ea.	30 Ea.	EO	
 <b>CB179NRP</b> Steel Full Mortise Standard Weight Hinge w/ Non- Removable Pin	4"x4"	26D	652			60.49	Ea	1Ea.	3 Ea.	48 Ea.	EO
		3	632			74.92	Ea	1Ea.	3 Ea.	48 Ea.	EO
	4.5"x4"	P	600	71453434		58.56	Ea	1Ea.	3 Ea.	48 Ea.	EO
		26D	652	71453436	✓	62.42	Ea	1Ea.	3 Ea.	48 Ea.	EO
		15	646	71453421		68.16	Ea	1Ea.	3 Ea.	48 Ea.	EO
		4	633	71453424		58.56	Ea	1Ea.	3 Ea.	48 Ea.	EO
		10	639			60.49	Ea	1Ea.	3 Ea.	48 Ea.	EO
	4.5"x4.5"	3	632			80.69	Ea	1Ea.	3 Ea.	48 Ea.	EO
		4	633	71457582		58.56	Ea	1Ea.	3 Ea.	48 Ea.	EO
		P	600	71458851	✓	58.56	Ea	1Ea.	3 Ea.	48 Ea.	EO
		10	639	71458852		60.49	Ea	1Ea.	3 Ea.	48 Ea.	EO
		26D	652	71458853	✓	62.42	Ea	1Ea.	3 Ea.	48 Ea.	EO
		10B	640	71458850		72.99	Ea	1Ea.	3 Ea.	48 Ea.	EO
		26	651	71458439		72.99	Ea	1Ea.	3 Ea.	48 Ea.	EO
		10A	641	71458857		82.59	Ea	1Ea.	3 Ea.	48 Ea.	EO
		3	632	71458847		80.69	Ea	1Ea.	3 Ea.	48 Ea.	EO
		5"x4.5"	26D	652	71453837	✓	90.31	Ea	1Ea.	3 Ea.	30 Ea.
5"x5"	26D	652			90.31	Ea	1Ea.	3 Ea.	30 Ea.	EO	
	10A	641			113.82	Ea	1Ea.	3 Ea.	30 Ea.	EO	

All prices are for items furnished with screws (as specified in catalog) unless otherwise stated in price list.  
 \* To price other finishes on architectural items – See pricing extras.

\*\* For conversion pins and decorative tips – See Miscellaneous Architectural Parts.  
 (X) Item must be ordered in these increments.

# Five Knuckle Architectural Hinges (cont.)

# Hinges & Door Accessories

	Model	Size	Finish	BHMA	EDP #	Stock Item	List Price	UOM	Order Multiple	Box Qty	Carton Qty	MPG
	<b>CB179NRP w/ SEC. ST.</b> Steel Full Mortise Standard Weight Hinge w/Security Stud	4.5"x4.5"	26D	652	71458444	✓	85.09	Ea	1Ea.	3 Ea.	30 Ea.	E0
	<b>CBK179</b> Steel Full Mortise Standard Weight Hinge w/Rust Resisting Base	4.5"x4.5"	P	600	71458432		72.11	Ea	1Ea.	3 Ea.	48 Ea.	E0
	<b>CBK179NRP</b> Steel Full Mortise Standard Weight Hinge w/Rust Resisting Base	4.5"x4.5"	P	600	71458849		81.24	Ea	1Ea.	3 Ea.	48 Ea.	E0
	<b>CECB179-12C</b> 12 Conductor Electrified Hinge w/ Quick Connect	4.5"x4.5"	26D	652	71450058		623.55	Ea	1Ea.	1Ea.	5 Ea.	D4
			3	632	71450055		641.82	Ea	1Ea.	1Ea.	5 Ea.	D4
			4	633	71450056		619.69	Ea	1Ea.	1Ea.	5 Ea.	D4
			10B	640	71450057		634.12	Ea	1Ea.	1Ea.	5 Ea.	D4
		5" x 4"	26D	652	71450100		651.43	Ea	1Ea.	1Ea.	5 Ea.	D4
		5" x 4.5"	10B	640	71450089		781.72	Ea	1Ea.	1Ea.	5 Ea.	D4
		5" x 4.5"	26D	652	71450105		651.43	Ea	1Ea.	1Ea.	5 Ea.	D4
	<b>CECB179-18</b> Steel Full Mortise Standard Weight Concealed Conductor Hinge Spec. 8- wire	4.5"x4.5"	26D	652	711839217	✓	604.76	Ea	1Ea.	1Ea.	5 Ea.	D4
		5"x4.5"	26D	652	711839225		632.65	Ea	1Ea.	1Ea.	5 Ea.	D4
	<b>CECB179-54</b> Steel Full Mortise Standard Weight Concealed Conductor Hinge 4- wire	4.5"x4"	26	651	71450331		477.60	Ea	1Ea.	1Ea.	5 Ea.	D4
			26D	652	71450330		467.03	Ea	1Ea.	1Ea.	5 Ea.	D4
		4.5"x4.5"	26D	652	71450352	✓	467.03	Ea	1Ea.	1Ea.	5 Ea.	D4
			26	651	71450376		477.60	Ea	1Ea.	1Ea.	5 Ea.	D4
			4	633	71450377		463.18	Ea	1Ea.	1Ea.	5 Ea.	D4
	<b>CECB179-66</b> Steel Full Mortise Standard Weight Concealed Conductor Hinge Spec. 6- wire	4.5"x4.5"	10	639	71450035		571.53	Ea	1Ea.	1Ea.	5 Ea.	D4
			10A	641	71450036		593.63	Ea	1Ea.	1Ea.	5 Ea.	D4
			26	651	71450038		584.03	Ea	1Ea.	1Ea.	5 Ea.	D4
			26D	652	71450034	✓	573.46	Ea	1Ea.	1Ea.	5 Ea.	D4
			3	632	71450037		591.73	Ea	1Ea.	1Ea.	5 Ea.	D4
		5"x4.5"	26D	652	71450039		637.57	Ea	1Ea.	1Ea.	5 Ea.	D4
	<b>HTCB179</b> Steel Full Mortise Standard Weight Hinge w/Hospital Tips	4.5"x4.5"	26D	652	71458856		92.74	Ea	1Ea.	3 Ea.	48 Ea.	E0

All prices are for items furnished with screws (as specified in catalog) unless otherwise stated in price list.  
 \* To price other finishes on architectural items – See pricing extras.



\*\* For conversion pins and decorative tips – See Miscellaneous Architectural Parts.  
 (X) Item must be ordered in these increments.

# Five Knuckle Architectural Hinges (cont.)

Model	Size	Finish	BHMA	EDP #	Stock Item	List Price	UOM	Order Multiple	Box Qty	Carton Qty	MPG	
 <b>F179</b> Steel Full Mortise Standard Weight Hinge	3"X3"	26D	652	71053252	✓	20.43	Ea	1Ea	2Ea	100 Ea	EO	
		3	632	71053256		24.47	Ea	1Ea	2Ea	100 Ea	EO	
		10B	640	71053200		24.24	Ea	1Ea	2Ea	100 Ea	EO	
		P	600	71053201		11.54	Ea	1Ea	2Ea	100 Ea	EO	
	35"X3"	4	633	71053054		12.00	Ea	1Ea	2Ea	100 Ea	EO	
	35"X35"	P	600	71050480		12.21	Ea	1Ea	2Ea	100 Ea	EO	
		4	633	71050491	✓	12.69	Ea	1Ea	2Ea	100 Ea	EO	
		10	639	71050482		16.13	Ea	1Ea	2Ea	100 Ea	EO	
		10*	693	71050479		13.71	Ea	1Ea	2Ea	100 Ea	EO	
		10A	641	71050483	✓	23.54	Ea	1Ea	2Ea	100 Ea	EO	
		26D	652	71050484	✓	21.59	Ea	1Ea	2Ea	100 Ea	EO	
		26	651	71050486	✓	23.54	Ea	1Ea	2Ea	100 Ea	EO	
		3	632	71050489	✓	24.29	Ea	1Ea	2Ea	100 Ea	EO	
		10B	640	71050400	✓	24.24	Ea	1Ea	2Ea	100 Ea	EO	
		10BL	-	71050421	✓	24.24	Ea	1Ea	2Ea	100 Ea	EO	
		15	646	71050401	✓	24.24	Ea	1Ea	2Ea	100 Ea	EO	
		15A	647	71050402		24.24	Ea	1Ea	2Ea	100 Ea	EO	
		5	638	71050403		23.03	Ea	1Ea	2Ea	100 Ea	EO	
		LA	-	71050481		14.37	Ea	1Ea	2Ea	100 Ea	EO	
		4"X3.5"	26D	652	71050522		26.90	Ea	1Ea	3Ea	48 Ea	EO
			3	632	71050523		31.71	Ea	1Ea	3Ea	48 Ea	EO
	26		651	71050524		31.71	Ea	1Ea	3Ea	48 Ea	EO	
	4"X4"	P	600	71050541	✓	15.36	Ea	1Ea	3Ea	48 Ea	EO	
		4	633	71050552	✓	15.36	Ea	1Ea	3Ea	48 Ea	EO	
		10*	693	71050556	✓	16.30	Ea	1Ea	3Ea	48 Ea	EO	
		26D	652	71050549	✓	24.01	Ea	1Ea	3Ea	48 Ea	EO	
		10A	641	71050546	✓	25.94	Ea	1Ea	3Ea	48 Ea	EO	
26		651	71050547	✓	27.84	Ea	1Ea	3Ea	48 Ea	EO		
3		632	71050551	✓	27.84	Ea	1Ea	3Ea	48 Ea	EO		
F8		-	71050554		27.70	Ea	1Ea	3Ea	48 Ea	EO		
10B		640	71050569	✓	28.83	Ea	1Ea	3Ea	48 Ea	EO		
10BL		-	71050575	✓	28.83	Ea	1Ea	3Ea	48 Ea	EO		
15		646	71050571	✓	32.67	Ea	1Ea	3Ea	48 Ea	EO		
15A		647	71050572		32.67	Ea	1Ea	3Ea	48 Ea	EO		
5		638	71050573		24.96	Ea	1Ea	3Ea	48 Ea	EO		
4.5"X4"		P	600	71053870		19.34	Ea	1Ea	3Ea	48 Ea	EO	
		19	631	71050315	✓	25.93	Ea	1Ea	3Ea	48 Ea	EO	
	4	633	71053879		20.17	Ea	1Ea	3Ea	48 Ea	EO		
	10	639	71053874		22.07	Ea	1Ea	3Ea	48 Ea	EO		
	26D	652	71053878	✓	28.83	Ea	1Ea	3Ea	48 Ea	EO		
	10A	641	71053875		33.61	Ea	1Ea	3Ea	48 Ea	EO		
	26	651	71053876		33.61	Ea	1Ea	3Ea	48 Ea	EO		
	3	632	71053877		33.61	Ea	1Ea	3Ea	48 Ea	EO		
	14	645			34.60	Ea	1Ea	3Ea	48 Ea	EO		
	15	646	71053856		25.94	Ea	1Ea	3Ea	48 Ea	EO		
	4.5"X4.5"	P	600	71050029	✓	19.31	Ea	1Ea	3Ea	48 Ea	EO	
		19	631	71050316	✓	25.93	Ea	1Ea	3Ea	48 Ea	EO	
4		633	71050042	✓	20.17	Ea	1Ea	3Ea	48 Ea	EO		
10		639	71050034	✓	22.07	Ea	1Ea	3Ea	48 Ea	EO		
26D		652	71050038	✓	28.83	Ea	1Ea	3Ea	48 Ea	EO		
10B		640	71050022	✓	33.61	Ea	1Ea	3Ea	48 Ea	EO		
10A		641	71050035	✓	33.61	Ea	1Ea	3Ea	48 Ea	EO		
26		651	71050036	✓	33.61	Ea	1Ea	3Ea	48 Ea	EO		
3		632	71050043	✓	33.61	Ea	1Ea	3Ea	48 Ea	EO		
F8		-	71050044		37.48	Ea	1Ea	3Ea	48 Ea	EO		
15		646	71050026	✓	32.67	Ea	1Ea	3Ea	48 Ea	EO		
10BL		-	71050030		34.60	Ea	1Ea	3Ea	48 Ea	EO		
DD		624E	71050046		24.01	Ea	1Ea	3Ea	48 Ea	EO		
LA		-			22.07	Ea	1Ea	3Ea	48 Ea	EO		
5"X4"		26D	652	71050736		53.84	Ea	1Ea	3Ea	30 Ea	EO	
	3	632	71050742		66.34	Ea	1Ea	3Ea	30 Ea	EO		
5"X4.5"	19	631			48.43	Ea	1Ea	3Ea	30 Ea	EO		
	26D	652	71050816		53.84	Ea	1Ea	3Ea	30 Ea	EO		
5"X5"	P	600	71050845		49.98	Ea	1Ea	3Ea	30 Ea	EO		
	19	631			48.43	Ea	1Ea	3Ea	30 Ea	EO		
	26D	652	71050853		53.84	Ea	1Ea	3Ea	30 Ea	EO		

# Five Knuckle Architectural Hinges (cont.)

## Hinges & Door Accessories



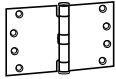

Model	Size	Finish	BHMA	EDP #	Stock Item	List Price	UOM	Order Multiple	Box Qty	Carton Qty	MPG
 <b>F179NRP</b> Steel Full Mortise Standard Weight Hinge w/ Non-Removable Pin	4"X4"	P	600	711055102	✓	23.94	Ea	1Ea.	3 Ea.	48 Ea.	EO
		26D	652	711050539		32.59	Ea	1Ea.	3 Ea.	48 Ea.	EO
	4.5"X4"	P	600	711053851	✓	27.92	Ea	1Ea.	3 Ea.	48 Ea.	EO
		19	631			36.31	Ea	1Ea.	3 Ea.	48 Ea.	EO
		26D	652	711053891		37.41	Ea	1Ea.	3 Ea.	48 Ea.	EO
		3	632	711053854		42.19	Ea	1Ea.	3 Ea.	48 Ea.	EO
	4.5"X4.5"	P	600	711050068	✓	27.89	Ea	1Ea.	3 Ea.	48 Ea.	EO
		19	631			31.99	Ea	1Ea.	3 Ea.	48 Ea.	EO
		10	639	711050075		30.65	Ea	1Ea.	3 Ea.	48 Ea.	EO
		26D	652	711050073	✓	37.41	Ea	1Ea.	3 Ea.	48 Ea.	EO
		10B	640	711050048		42.19	Ea	1Ea.	3 Ea.	48 Ea.	EO
		10A	641	711050071		42.19	Ea	1Ea.	3 Ea.	48 Ea.	EO
		26	651	711050049		42.19	Ea	1Ea.	3 Ea.	30 Ea.	EO
		10BL	-	711050031		43.18	Ea	1Ea.	3 Ea.	48 Ea.	EO
		5"X4.5"	19	631			52.95	Ea	1Ea.	3 Ea.	30 Ea.
	5"X5"	P	600	711050844		58.56	Ea	1Ea.	3 Ea.	30 Ea.	EO
		19	631			57.95	Ea	1Ea.	3 Ea.	30 Ea.	EO
		26D	652	711050863		62.42	Ea	1Ea.	3 Ea.	30 Ea.	EO
 <b>F179BT**</b> Steel Full Mortise Standard Weight Hinge with Ball Tips	3"X3"	3	632	711053251		77.41	Ea	1Ea.	2 Ea.	48 Ea.	EO
	3.5"X3.5"	3	632	711050405		77.23	Ea	1Ea.	2 Ea.	48 Ea.	EO
	4"X4"	3	632	711050561		80.78	Ea	1Ea.	3 Ea.	48 Ea.	EO
	4.5"X4.5"	3	632	711050085		86.55	Ea	1Ea.	3 Ea.	48 Ea.	EO
 <b>F179ST**</b> Steel Full Mortise Standard Weight Hinge with Steeple Tip	3.5"X3.5"	3	632	711050493		77.23	Ea	1Ea.	2 Ea.	48 Ea.	EO
	4"X4"	3	632	711050559		80.78	Ea	1Ea.	3 Ea.	48 Ea.	EO
	4.5"X4.5"	3	632	711050086		86.55	Ea	1Ea.	3 Ea.	48 Ea.	EO

# Five Knuckle Architectural Hinges (cont.)

Model	Size	Finish	BHMA	EDP #	Stock Item	List Price	UOM	Order Multiple	Box Qty	Carton Qty	MPG
 <b>F179WT</b> Wide Throw Steel Full Mortise Standard Weight Hinge	3.5"X5"	4	633	711054827		5188	Ea	1Ea.	2 Ea.	50 Ea.	EO
		P	600	711054830		5188	Ea	1Ea.	2 Ea.	50 Ea.	EO
		26D	652	711054833		66.31	Ea	1Ea.	2 Ea.	50 Ea.	EO
		3	632	711054828		76.41	Ea	1Ea.	2 Ea.	50 Ea.	EO
		10A	641	711054834		76.41	Ea	1Ea.	2 Ea.	50 Ea.	EO
		26	651	711054835		76.41	Ea	1Ea.	2 Ea.	50 Ea.	EO
		P	600	711054837		54.77	Ea	1Ea.	2 Ea.	50 Ea.	EO
		4	633	711054844		54.77	Ea	1Ea.	2 Ea.	50 Ea.	EO
		26D	652	711054840		66.31	Ea	1Ea.	2 Ea.	50 Ea.	EO
		10A	641	711054841		76.41	Ea	1Ea.	2 Ea.	50 Ea.	EO
3.5"X6"	4	633	711054843		76.41	Ea	1Ea.	2 Ea.	50 Ea.	EO	
	26	651	711054835		76.41	Ea	1Ea.	2 Ea.	50 Ea.	EO	
	P	600	711054837		54.77	Ea	1Ea.	2 Ea.	50 Ea.	EO	
	4	633	711054844		54.77	Ea	1Ea.	2 Ea.	50 Ea.	EO	
	26D	652	711054840		66.31	Ea	1Ea.	2 Ea.	50 Ea.	EO	
4"X5"	10A	641	711054841		76.41	Ea	1Ea.	2 Ea.	50 Ea.	EO	
	3	632	711054843		76.41	Ea	1Ea.	2 Ea.	50 Ea.	EO	
	4	633	711055112		87.50	Ea	1Ea.	3 Ea.	48 Ea.	EO	
	P	600	711055115		87.50	Ea	1Ea.	3 Ea.	48 Ea.	EO	
	26D	652	711055118		99.04	Ea	1Ea.	3 Ea.	48 Ea.	EO	
4"X6"	3	632	711055113		110.58	Ea	1Ea.	3 Ea.	48 Ea.	EO	
	10A	641	711055119		110.58	Ea	1Ea.	3 Ea.	48 Ea.	EO	
	26	651	711055121		110.58	Ea	1Ea.	3 Ea.	48 Ea.	EO	
	P	600	711055122		87.50	Ea	1Ea.	3 Ea.	48 Ea.	EO	
	4	633	711055134		87.50	Ea	1Ea.	3 Ea.	48 Ea.	EO	
4"X7"	10	639	711055124		91.33	Ea	1Ea.	3 Ea.	48 Ea.	EO	
	26D	652	711055125		99.98	Ea	1Ea.	3 Ea.	48 Ea.	EO	
	3	632	711055111		110.58	Ea	1Ea.	3 Ea.	48 Ea.	EO	
	10A	641	711055126		110.58	Ea	1Ea.	3 Ea.	48 Ea.	EO	
	P	600	711055128		87.50	Ea	1Ea.	3 Ea.	36 Ea.	EO	
4.5"X5"	4	633	711055136		87.50	Ea	1Ea.	3 Ea.	36 Ea.	EO	
	26D	652	711055131		99.04	Ea	1Ea.	3 Ea.	36 Ea.	EO	
	10A	641	711055132		110.58	Ea	1Ea.	3 Ea.	36 Ea.	EO	
	3	632	711055135		110.58	Ea	1Ea.	3 Ea.	36 Ea.	EO	
	P	600	711053511		134.61	Ea	1Ea.	3 Ea.	36 Ea.	EO	
4.5"X6"	26D	652	711053514		160.58	Ea	1Ea.	3 Ea.	36 Ea.	EO	
	10A	641	711053515		172.12	Ea	1Ea.	3 Ea.	36 Ea.	EO	
	3	632	711053517		172.12	Ea	1Ea.	3 Ea.	36 Ea.	EO	
	P	600	711053754		126.94	Ea	1Ea.	3 Ea.	36 Ea.	EO	
	4	633	711053763		148.09	Ea	1Ea.	3 Ea.	36 Ea.	EO	
4.5"X7"	10	639	711053758		152.91	Ea	1Ea.	3 Ea.	36 Ea.	EO	
	26D	652	711053759		160.58	Ea	1Ea.	3 Ea.	36 Ea.	EO	
	10A	641	711053760		159.64	Ea	1Ea.	3 Ea.	36 Ea.	EO	
	26	651	711053761		172.12	Ea	1Ea.	3 Ea.	36 Ea.	EO	
	3	632	711053762		172.12	Ea	1Ea.	3 Ea.	36 Ea.	EO	
4.5"X8"	P	600	711055438		148.09	Ea	1Ea.	3 Ea.	30 Ea.	EO	
	26D	652	711055441		160.58	Ea	1Ea.	3 Ea.	30 Ea.	EO	
5"X8"	P	600	711055444		172.12	Ea	1Ea.	3 Ea.	30 Ea.	EO	
	26D	652	711055447		148.09	Ea	1Ea.	3 Ea.	30 Ea.	EO	
	5"X8"	26D	652	711050878		160.58	Ea	1Ea.	3 Ea.	18 Ea.	EO

# Five Knuckle Architectural Hinges (cont.)

# Hinges & Door Accessories

	Model	Size	Finish	BHMA	EDP #	Stock Item	List Price	UOM	Order Multiple	Box Qty	Carton Qty	MPG
	<b>RDF179</b> Steel Full Mortise Standard Weight 1/4" Radius Corner Hinge	3.5"x3.5"	P	600	711050498		22.97	Ea.	1Ea.	2 Ea.	100 Ea.	E0
			4	633	711050505		23.46	Ea.	1Ea.	2 Ea.	100 Ea.	E0
			26D	652	711050501	✓	32.35	Ea.	1Ea.	2 Ea.	100 Ea.	E0
			10A	641	711050500		34.31	Ea.	1Ea.	2 Ea.	100 Ea.	E0
			3	632	711050504		35.06	Ea.	1Ea.	2 Ea.	100 Ea.	E0
			10B	640	711050408		35.00	Ea.	1Ea.	2 Ea.	100 Ea.	E0
			15	646	711050409	✓	35.00	Ea.	1Ea.	2 Ea.	100 Ea.	E0
			15A	647	711050410		35.00	Ea.	1Ea.	2 Ea.	100 Ea.	E0
			26	651	711050411		34.31	Ea.	1Ea.	2 Ea.	100 Ea.	E0
		5	638	711050412		33.79	Ea.	1Ea.	2 Ea.	100 Ea.	E0	
		4"x4"	4	633	711050532		26.12	Ea.	1Ea.	3 Ea.	48 Ea.	E0
			26D	652	711050537		34.78	Ea.	1Ea.	3 Ea.	48 Ea.	E0
			3	632	711050526		38.61	Ea.	1Ea.	3 Ea.	48 Ea.	E0
			10A	641	711050530		36.71	Ea.	1Ea.	3 Ea.	48 Ea.	E0
			15	646	711050415	✓	43.43	Ea.	1Ea.	3 Ea.	48 Ea.	E0
			5	638	711050418		35.72	Ea.	1Ea.	3 Ea.	48 Ea.	E0
			15A	647	711050416		43.43	Ea.	1Ea.	3 Ea.	48 Ea.	E0
			P	600	711050420		26.12	Ea.	1Ea.	3 Ea.	48 Ea.	E0
	<b>RDF179NRP</b> Steel Full Mortise Standard Weight 1/4" Radius Corner Hinge w/ Non-Removable Pin	4"x4"	4	633	711050558		34.70	Ea.	1Ea.	3 Ea.	48 Ea.	E0
			26D	652	711050533		43.36	Ea.	1Ea.	3 Ea.	48 Ea.	E0
			10A	641	711050528		45.29	Ea.	1Ea.	3 Ea.	48 Ea.	E0
			3	632	711050535		47.19	Ea.	1Ea.	3 Ea.	48 Ea.	E0
	<b>F179K</b> Steel Full Mortise Standard Weight Hinge w/Rust Resisting Base	4.5"x4.5"	P	600			41.98	Ea.	1Ea.	3 Ea.	48 Ea.	E0
	<b>CEFBB179-54</b> Steel Full Mortise Standard Weight Concealed Conductor Hinge 4- wire	4.5"x4"	26D	652	711060330	✓	465.11	Ea.	1Ea.	1Ea.	5 Ea.	D4
			P	600	711060334		455.46	Ea.	1Ea.	1Ea.	5 Ea.	D4
		4.5"x4.5"	P	600	711060370		455.46	Ea.	1Ea.	1Ea.	5 Ea.	D4
			26D	652	711060352	✓	463.18	Ea.	1Ea.	1Ea.	5 Ea.	D4
			10	639	711060373		458.35	Ea.	1Ea.	1Ea.	5 Ea.	D4
			10A	641	711060375		474.72	Ea.	1Ea.	1Ea.	5 Ea.	D4
			26	651	711060376		474.72	Ea.	1Ea.	1Ea.	5 Ea.	D4
			3	632	711060378		474.72	Ea.	1Ea.	1Ea.	5 Ea.	D4
		5"x4.5"	26D	652	711060382		492.98	Ea.	1Ea.	1Ea.	5 Ea.	D4
			<b>CEFBB179-66</b> Steel Full Mortise Standard Weight Concealed Conductor Hinge Spec. 6- wire	4.5"x4.5"	10	639	711060101		583.56	Ea.	1Ea.	1Ea.
10A	641				711060102		599.93	Ea.	1Ea.	1Ea.	5 Ea.	D4
5"x4.5"	26D			652	711060100		588.39	Ea.	1Ea.	1Ea.	5 Ea.	D4
	26D			652	711060105		618.19	Ea.	1Ea.	1Ea.	5 Ea.	D4

All prices are for items furnished with screws (as specified in catalog) unless otherwise stated in price list.  
\* To price other finishes on architectural items – See pricing extras.

\*\* For conversion pins and decorative tips – See Miscellaneous Architectural Parts.  
(X) Item must be ordered in these increments.

# Five Knuckle Architectural Hinges (cont.)

Model	Size	Finish	BHMA	EDP #	Stock Item	List Price	UOM	Order Multiple	Box Qty	Carton Qty	MPG
 <b>FBB179</b> Steel Full Mortise Standard Weight Hinge	3.5"X3.5"	26D	652	71068096	✓	47.10	Ea	1Ea	3 Ea	90 Ea	EO
		3	632	71068099		55.76	Ea	1Ea	3 Ea	90 Ea	EO
		26	651	71068095		57.68	Ea	1Ea	3 Ea	90 Ea	EO
		4	633	71068100		32.67	Ea	1Ea	3 Ea	90 Ea	EO
	3.5"X5"	10BL	-	71069844		55.33	Ea	1Ea	3 Ea	48 Ea	EO
	4"X3.5"	26D	652	71067244		47.10	Ea	1Ea	3 Ea	48 Ea	EO
		3	632	71067245		57.68	Ea	1Ea	3 Ea	48 Ea	EO
	4"X4"	P	600	71067282		39.39	Ea	1Ea	3 Ea	48 Ea	EO
		4	633	71068278		39.39	Ea	1Ea	3 Ea	48 Ea	EO
		26D	652	71068261	✓	45.16	Ea	1Ea	3 Ea	48 Ea	EO
10		639	71068201		41.33	Ea	1Ea	3 Ea	48 Ea	EO	
10A		641	71068202	✓	55.76	Ea	1Ea	3 Ea	48 Ea	EO	
3		632	71068277	✓	60.57	Ea	1Ea	3 Ea	48 Ea	EO	
26		651	71068279		55.76	Ea	1Ea	3 Ea	48 Ea	EO	
F8		-	71067283		68.24	Ea	1Ea	3 Ea	48 Ea	EO	
15		646	71069836		61.53	Ea	1Ea	3 Ea	48 Ea	EO	
5		638	71069838		51.91	Ea	1Ea	3 Ea	48 Ea	EO	
15A		647	71069837		61.53	Ea	1Ea	3 Ea	48 Ea	EO	
4.5"X4"		P	600	71063412	✓	42.27	Ea	1Ea	3 Ea	48 Ea	EO
		19	631	71950317	✓	46.70	Ea	1Ea	3 Ea	48 Ea	EO
		4	633	71063437		42.27	Ea	1Ea	3 Ea	48 Ea	EO
		10	639	71063413	✓	45.16	Ea	1Ea	3 Ea	48 Ea	EO
	26D	652	71063416	✓	51.91	Ea	1Ea	3 Ea	48 Ea	EO	
	26	651	71063415	✓	61.53	Ea	1Ea	3 Ea	48 Ea	EO	
	3	632	71063419	✓	61.53	Ea	1Ea	3 Ea	48 Ea	EO	
	10A	641	71063429	✓	62.47	Ea	1Ea	3 Ea	48 Ea	EO	
	15	646	71063431	✓	59.58	Ea	1Ea	3 Ea	48 Ea	EO	
	14	645	71063430		59.58	Ea	1Ea	3 Ea	48 Ea	EO	
	4.5"X4.5"	P	600	71068431	✓	42.27	Ea	1Ea	3 Ea	48 Ea	EO
		19	631	71950318	✓	46.70	Ea	1Ea	3 Ea	48 Ea	EO
		4	633	71068784	✓	42.27	Ea	1Ea	3 Ea	48 Ea	EO
		10	639	71068381	✓	45.16	Ea	1Ea	3 Ea	48 Ea	EO
		10*	693	71068785		55.76	Ea	1Ea	3 Ea	48 Ea	EO
26D		652	71068441	✓	49.98	Ea	1Ea	3 Ea	48 Ea	EO	
10B		640	71067583	✓	61.53	Ea	1Ea	3 Ea	48 Ea	EO	
10BL		-	71069843		61.53	Ea	1Ea	3 Ea	48 Ea	EO	
10A		641	71068383	✓	61.53	Ea	1Ea	3 Ea	48 Ea	EO	
3		632	71068436	✓	61.53	Ea	1Ea	3 Ea	48 Ea	EO	
26		651	71068438	✓	61.53	Ea	1Ea	3 Ea	48 Ea	EO	
15		646	71067585	✓	59.58	Ea	1Ea	3 Ea	48 Ea	EO	
5"X4"		P	600	71067888		61.53	Ea	1Ea	3 Ea	30 Ea	EO
		4	633	71067882		57.68	Ea	1Ea	3 Ea	30 Ea	EO
		26D	652	71067885		68.24	Ea	1Ea	3 Ea	30 Ea	EO
5"X4.5"	P	600	71063818		74.01	Ea	1Ea	3 Ea	30 Ea	EO	
	19	631			71.77	Ea	1Ea	3 Ea	30 Ea	EO	
	10	639	71063821		77.88	Ea	1Ea	3 Ea	30 Ea	EO	
	26D	652	71063823	✓	79.78	Ea	1Ea	3 Ea	30 Ea	EO	
5"X5"	P	600	71068618	✓	74.01	Ea	1Ea	3 Ea	30 Ea	EO	
	19	631			73.52	Ea	1Ea	3 Ea	30 Ea	EO	
	4	633	71068625		74.01	Ea	1Ea	3 Ea	30 Ea	EO	
	26D	652	71068624	✓	81.73	Ea	1Ea	3 Ea	30 Ea	EO	
	3	632	71068627		101.92	Ea	1Ea	3 Ea	30 Ea	EO	
	10A	641	71068622		98.08	Ea	1Ea	3 Ea	30 Ea	EO	
6"X5"	P	600	71068113		154.81	Ea	1Ea	3 Ea	24 Ea	EO	
6"X6"	P	600	71068123		154.81	Ea	1Ea	3 Ea	24 Ea	EO	
	26D	652	71068128		179.83	Ea	1Ea	3 Ea	24 Ea	EO	





All prices are for items furnished with screws (as specified in catalog) unless otherwise stated in price list.  
 \* To price other finishes on architectural items – See pricing extras.

\*\* For conversion pins and decorative tips – See Miscellaneous Architectural Parts.  
 (X) Item must be ordered in these increments.

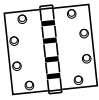

# Five Knuckle Architectural Hinges (cont.)

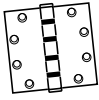
# Hinges & Door Accessories

	Model	Size	Finish	BHMA	EDP #	Stock Item	List Price	UOM	Order Multiple	Box Qty	Carton Qty	MPG
	<b>QKSFBB179</b> By LOCKT Steel Adjustable Full Mortise Standard Weight Hinge	4.5"x4.5"	26D	652	7265994		46.79	Ea	30 Ea.	3 Ea.	30 Ea.	EO
	<b>FBB179NRP</b> Steel Full Mortise Standard Weight Hinge w/ Non- Removable Pin	3.5"x3"	3	632	71068019		64.34	Ea	1Ea.	3 Ea.	90 Ea.	EO
		3.5"x3.5"	26D	652	71068097		55.68	Ea	1Ea.	3 Ea.	90 Ea.	EO
			3	632	71068169		64.34	Ea	1Ea.	3 Ea.	90 Ea.	EO
		4"x3.5"	26D	652	71067241		55.68	Ea	1Ea.	3 Ea.	48 Ea.	EO
		4"x4"	P	600	71067270		47.97	Ea	1Ea.	3 Ea.	48 Ea.	EO
			4	633	71067269		47.97	Ea	1Ea.	3 Ea.	48 Ea.	EO
			10	639	71067265		49.91	Ea	1Ea.	3 Ea.	48 Ea.	EO
			26D	652	71068281	✓	53.74	Ea	1Ea.	3 Ea.	48 Ea.	EO
			10A	641	71067266		64.34	Ea	1Ea.	3 Ea.	48 Ea.	EO
			26	651	71067267		64.34	Ea	1Ea.	3 Ea.	48 Ea.	EO
			3	632	71067268		69.15	Ea	1Ea.	3 Ea.	48 Ea.	EO
		4.5"x4"	P	600	71063434	✓	50.85	Ea	1Ea.	3 Ea.	48 Ea.	EO
			19	631	71950319	✓	55.34	Ea	1Ea.	3 Ea.	48 Ea.	EO
			4	633	71063424		50.85	Ea	1Ea.	3 Ea.	48 Ea.	EO
			10	639	71063411		53.74	Ea	1Ea.	3 Ea.	48 Ea.	EO
			26D	652	71063436	✓	60.49	Ea	1Ea.	3 Ea.	48 Ea.	EO
			3	632	71063423		70.11	Ea	1Ea.	3 Ea.	48 Ea.	EO
			10A	641	71063435		71.05	Ea	1Ea.	3 Ea.	48 Ea.	EO
			15	646	71063421		68.16	Ea	1Ea.	3 Ea.	48 Ea.	EO
			26	651	71063422		70.11	Ea	1Ea.	3 Ea.	48 Ea.	EO
		4.5"x4.5"	P	600	71068851	✓	50.85	Ea	1Ea.	3 Ea.	48 Ea.	EO
			19	631	71950320	✓	55.34	Ea	1Ea.	3 Ea.	48 Ea.	EO
			4	633	71067582	✓	50.85	Ea	1Ea.	3 Ea.	48 Ea.	EO
			10	639	71068852	✓	53.74	Ea	1Ea.	3 Ea.	48 Ea.	EO
			26D	652	71068853	✓	58.56	Ea	1Ea.	3 Ea.	48 Ea.	EO
			26	651	71068439	✓	70.11	Ea	1Ea.	3 Ea.	48 Ea.	EO
			10A	641	71068857	✓	70.11	Ea	1Ea.	3 Ea.	48 Ea.	EO
			3	632	71068847	✓	70.11	Ea	1Ea.	3 Ea.	48 Ea.	EO
			10B	640	71068850		70.11	Ea	1Ea.	3 Ea.	48 Ea.	EO
		5"x4.5"	P	600	71063836		82.59	Ea	1Ea.	3 Ea.	30 Ea.	EO
			19	631			79.56	Ea	1Ea.	3 Ea.	30 Ea.	EO
			10A	641	71068634		106.04	Ea	1Ea.	3 Ea.	30 Ea.	EO
			26D	652	71063837		88.36	Ea	1Ea.	3 Ea.	30 Ea.	EO
		5"x5"	P	600	71068632		82.59	Ea	1Ea.	3 Ea.	30 Ea.	EO
			19	631			83.10	Ea	1Ea.	3 Ea.	30 Ea.	EO
			4	633	71068637	✓	82.59	Ea	1Ea.	3 Ea.	30 Ea.	EO
			26D	652	71068631		90.31	Ea	1Ea.	3 Ea.	30 Ea.	EO
			3	632	71068636		110.50	Ea	1Ea.	3 Ea.	30 Ea.	EO
			10A	641	71068635		106.66	Ea	1Ea.	3 Ea.	30 Ea.	EO
	<b>QKSFBB179NRP</b> By LOCKT Steel Adjustable Full Mortise Standard Weight Hinge w/ Non- Removable Pin	4.5"x4.5"	26D	652	7265995		55.37	Ea	30 Ea.	3 Ea.	30 Ea.	EO
	<b>FBB179NRP w/ SEC. ST.</b> Steel Full Mortise Standard Weight Hinge x Security Stud	4.5"x4.5"	26D	652	71068444		81.24	Ea	1Ea.	3 Ea.	48 Ea.	EO
	<b>FBB179BT**</b> Steel Full Mortise Standard Weight Hinge with Ball Tips	4.5"x4.5"	3	632	71068846		114.46	Ea	1Ea.	3 Ea.	48 Ea.	EO

All prices are for items furnished with screws (as specified in catalog) unless otherwise stated in price list.  
\* To price other finishes on architectural items – See pricing extras.

\*\* For conversion pins and decorative tips – See Miscellaneous Architectural Parts.  
(X) Item must be ordered in these increments.

# Five Knuckle Architectural Hinges (cont.)

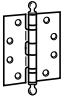
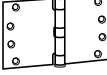



Model	Size	Finish	BHMA	EDP #	Stock Item	List Price	UOM	Order Multiple	Box Qty	Carton Qty	MPG
 <b>FBB179ST**</b> Steel Full Mortise Standard Weight Hinge with Steeple Tips	4.5"x4.5"	3	632	71068845		6153	Ea	1Ea	3 Ea	48 Ea	EO
	 <b>FBB179WT</b> Steel Wide Throw Full Mortise Standard Weight Hinge	3.5"x5"	P	600	71068133		80.77	Ea	1Ea	3 Ea	48 Ea
4		633	71068134		80.77	Ea	1Ea	3 Ea	48 Ea	EO	
1D*		693	71068136		83.65	Ea	1Ea	3 Ea	48 Ea	EO	
10		639	71068137		83.65	Ea	1Ea	3 Ea	48 Ea	EO	
26D		652	71068138		91.33	Ea	1Ea	3 Ea	48 Ea	EO	
3		632	71068139		102.87	Ea	1Ea	3 Ea	48 Ea	EO	
10A		641	71068140		102.87	Ea	1Ea	3 Ea	48 Ea	EO	
10B		640	71068141		102.87	Ea	1Ea	3 Ea	48 Ea	EO	
3.5"x6"		P	600	71068143		80.77	Ea	1Ea	3 Ea	48 Ea	EO
4		633	71068144		80.77	Ea	1Ea	3 Ea	48 Ea	EO	
26D		652	71068148		91.33	Ea	1Ea	3 Ea	48 Ea	EO	
3		632	71068149		102.87	Ea	1Ea	3 Ea	48 Ea	EO	
10B		640	71068151		102.87	Ea	1Ea	3 Ea	48 Ea	EO	
4"x5"		P	600	71065121		113.47	Ea	1Ea	3 Ea	48 Ea	EO
4		633	71065122		113.47	Ea	1Ea	3 Ea	48 Ea	EO	
26D		652	71065126		125.01	Ea	1Ea	3 Ea	48 Ea	EO	
3		632	71065127		136.55	Ea	1Ea	3 Ea	48 Ea	EO	
10A		641	71065128		136.55	Ea	1Ea	3 Ea	48 Ea	EO	
10BL		-	71065151		136.55	Ea	1Ea	3 Ea	48 Ea	EO	
10B		640	71065129		136.55	Ea	1Ea	3 Ea	48 Ea	EO	
4"x6"		P	600	71065131		113.47	Ea	1Ea	3 Ea	48 Ea	EO
4		633	71065132		113.47	Ea	1Ea	3 Ea	48 Ea	EO	
1D*		693	71065134		117.30	Ea	1Ea	3 Ea	48 Ea	EO	
10		639	71065135		117.30	Ea	1Ea	3 Ea	48 Ea	EO	
26D		652	71065136		125.01	Ea	1Ea	3 Ea	48 Ea	EO	
3		632	71065137		136.55	Ea	1Ea	3 Ea	48 Ea	EO	
10A		641	71065138		128.84	Ea	1Ea	3 Ea	48 Ea	EO	
10B		640	71065139		136.55	Ea	1Ea	3 Ea	48 Ea	EO	
26	651	71065140		136.55	Ea	1Ea	3 Ea	48 Ea	EO		
10BL	-	71065152		136.55	Ea	1Ea	3 Ea	48 Ea	EO		
4"x7"	26D	652	71065146		122.12	Ea	1Ea	3 Ea	48 Ea	EO	
3	632	71065147		136.55	Ea	1Ea	3 Ea	48 Ea	EO		
10B	640	71065149		136.55	Ea	1Ea	3 Ea	48 Ea	EO		
10BL	-	71065153		136.55	Ea	1Ea	3 Ea	48 Ea	EO		
4.5"x5"	P	600	71068863		145.21	Ea	1Ea	3 Ea	30 Ea	EO	
4	633	71068864		174.06	Ea	1Ea	3 Ea	30 Ea	EO		
10	639	71068867		148.09	Ea	1Ea	3 Ea	30 Ea	EO		
26D	652	71068868		163.46	Ea	1Ea	3 Ea	30 Ea	EO		
3	632	71068869		199.08	Ea	1Ea	3 Ea	30 Ea	EO		
10A	641	71068870		199.08	Ea	1Ea	3 Ea	30 Ea	EO		
10B	640	71068871		199.08	Ea	1Ea	3 Ea	30 Ea	EO		
26	651	71068872		199.08	Ea	1Ea	3 Ea	30 Ea	EO		
4.5"x6"	P	600	71068873		174.06	Ea	1Ea	3 Ea	30 Ea	EO	
4	633	71068874		174.06	Ea	1Ea	3 Ea	30 Ea	EO		
1D*	693	71068876		177.89	Ea	1Ea	3 Ea	30 Ea	EO		
10	639	71068877		177.89	Ea	1Ea	3 Ea	30 Ea	EO		
26D	652	71068878	✓	163.46	Ea	1Ea	3 Ea	30 Ea	EO		
3	632	71068879		171.18	Ea	1Ea	3 Ea	30 Ea	EO		
10A	641	71068880		199.08	Ea	1Ea	3 Ea	30 Ea	EO		
10B	640	71068881		199.08	Ea	1Ea	3 Ea	30 Ea	EO		
26	651	71068882		199.08	Ea	1Ea	3 Ea	30 Ea	EO		
10BL	-	71069849		199.08	Ea	1Ea	3 Ea	30 Ea	EO		

All prices are for items furnished with screws (as specified in catalog) unless otherwise stated in price list.  
 \* To price other finishes on architectural items – See pricing extras.

\*\* For conversion pins and decorative tips – See Miscellaneous Architectural Parts.  
 (X) Item must be ordered in these increments.

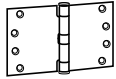
# Five Knuckle Architectural Hinges (cont.)



# Hinges & Door Accessories

Model	Size	Finish	BHMA	EDP #	Stock Item	List Price	UOM	Order Multiple	Box Qty	Carton Qty	MPG
 <b>FBB179WT (Cont.)</b> Steel Wide Throw Full Mortise Standard Weight Hinge	4.5"x7"	P	600	71068883		174.06	Ea	1Ea	3 Ea	30 Ea	EO
		4	633	71068884		174.06	Ea	1Ea	3 Ea	30 Ea	EO
		10	639	71068887		177.89	Ea	1Ea	3 Ea	30 Ea	EO
		26D	652	71068888		163.46	Ea	1Ea	3 Ea	30 Ea	EO
		10B	640	71068891		199.08	Ea	1Ea	3 Ea	30 Ea	EO
		26	651	71068892		199.08	Ea	1Ea	3 Ea	30 Ea	EO
		10BL	-	71069850		187.99	Ea	1Ea	3 Ea	15 Ea	EO
	3	632			195.59	Ea	1Ea	3 Ea	30 Ea	EO	
	4.5"x8"	P	600	71068893		174.06	Ea	1Ea	3 Ea	30 Ea	EO
		4	633	71068894		174.06	Ea	1Ea	3 Ea	30 Ea	EO
		10	639	71068897		177.89	Ea	1Ea	3 Ea	30 Ea	EO
		26D	652	71068898		163.46	Ea	1Ea	3 Ea	30 Ea	EO
		3	632	71068899		199.08	Ea	1Ea	3 Ea	30 Ea	EO
		10A	641	71068900		199.08	Ea	1Ea	3 Ea	30 Ea	EO
		10B	640	71068901		199.08	Ea	1Ea	3 Ea	30 Ea	EO
	10BL	-	71069851		200.98	Ea	1Ea	3 Ea	30 Ea	EO	
	5"x7"	P	600	710688650		212.52	Ea	1Ea	3 Ea	18 Ea	EO
		4	633	710688651		212.52	Ea	1Ea	3 Ea	18 Ea	EO
		26D	652	710688654		237.55	Ea	1Ea	3 Ea	18 Ea	EO
		3	632	710688655		237.55	Ea	1Ea	3 Ea	18 Ea	EO
		10A	641	710688656		237.55	Ea	1Ea	3 Ea	18 Ea	EO
10B		640	710688657		237.55	Ea	1Ea	3 Ea	18 Ea	EO	
5"x8"	4	633	710688660		212.52	Ea	1Ea	3 Ea	18 Ea	EO	
	10	639	710688663		216.39	Ea	1Ea	3 Ea	18 Ea	EO	
	26D	652	710688664		226.00	Ea	1Ea	3 Ea	18 Ea	EO	
	3	632	710688665		237.55	Ea	1Ea	3 Ea	18 Ea	EO	
 <b>FBBK179</b> Steel Full Mortise Standard Weight Hinge w/Rust Resisting Base	4.5"x4.5"	P	600	71068432		64.94	Ea	1Ea	3 Ea	48 Ea	EO
 <b>FBBK179NRP</b> Steel Full Mortise Standard Weight Hinge w/Rust Resisting Base and Non-Removable Pin	4.5"x4.5"	P	600	71068849		96.19	Ea	1Ea	3 Ea	48 Ea	EO
 <b>HTFBB179</b> Steel Full Mortise Standard Weight Hinge w/Hospital Tips	4.5"x4.5"	26D	652	71068856	✓	88.88	Ea	1Ea	3 Ea	48 Ea	EO
 <b>RDFBB179</b> Steel Full Mortise Standard Weight 1/4" Radius Corner Hinge	3.5"x3.5"	3	632	71068293		66.52	Ea	1Ea	3 Ea	48 Ea	EO
		4	633	71068294		43.43	Ea	1Ea	3 Ea	48 Ea	EO
		26D	652	71068295		57.86	Ea	1Ea	3 Ea	48 Ea	EO
	4"x4"	26D	652	71068287		55.92	Ea	1Ea	3 Ea	48 Ea	EO
		26	651	71069840		66.52	Ea	1Ea	3 Ea	48 Ea	EO
		4	633	71069842		50.15	Ea	1Ea	3 Ea	48 Ea	EO
		3	632	71069841		71.33	Ea	1Ea	3 Ea	48 Ea	EO

All prices are for items furnished with screws (as specified in catalog) unless otherwise stated in price list.  
 \* To price other finishes on architectural items – See pricing extras.

\*\* For conversion pins and decorative tips – See Miscellaneous Architectural Parts.  
 (X) Item must be ordered in these increments.



# Five Knuckle Architectural Hinges (cont.)

Model	Size	Finish	BHMA	EDP #	Stock Item	List Price	UOM	Order Multiple	Box Qty	Carton Qty	MPG	
 <b>CB191</b> Brass, Bronze or Stainless Steel Full Mortise Standard Weight Hinge	35"X3.5"	10B	613	71443350		75.00	Ea	1Ea.	3 Ea.	90 Ea.	E0	
		3	605	71443334		118.28	Ea	1Ea.	3 Ea.	90 Ea.	E0	
		26D	626	71446056		70.18	Ea	1Ea.	3 Ea.	90 Ea.	E0	
		32D	630	71443657		111.52	Ea	1Ea.	3 Ea.	90 Ea.	E0	
	4"X4"	3	605	71443364		125.01	Ea	1Ea.	3 Ea.	48 Ea.	E0	
		10B	613	71443374		84.61	Ea	1Ea.	3 Ea.	48 Ea.	E0	
		26D	626	71443362		100.97	Ea	1Ea.	3 Ea.	48 Ea.	E0	
		32D	630	71440077	✓	128.84	Ea	1Ea.	3 Ea.	48 Ea.	E0	
	4.5"X4"	26D	626	71447236		107.70	Ea	1Ea.	3 Ea.	48 Ea.	E0	
		626W	626W	71950281		110.91	Ea	1Ea.	3 Ea.	48 Ea.	E0	
		3	605	71447238		128.84	Ea	1Ea.	3 Ea.	48 Ea.	E0	
		32D	630	71444156	✓	141.36	Ea	1Ea.	3 Ea.	48 Ea.	E0	
		630W	630W	71950280		145.20	Ea	1Ea.	3 Ea.	48 Ea.	E0	
		10B	613	71447203		109.62	Ea	1Ea.	3 Ea.	48 Ea.	E0	
	4.5"X4.5"	4	606	71443403		107.70	Ea	1Ea.	3 Ea.	48 Ea.	E0	
		10	612	71443422		94.21	Ea	1Ea.	3 Ea.	48 Ea.	E0	
		26D	626	71443392	✓	107.70	Ea	1Ea.	3 Ea.	48 Ea.	E0	
		626W	626W	71950279		110.91	Ea	1Ea.	3 Ea.	48 Ea.	E0	
		26	625	71443389		143.27	Ea	1Ea.	3 Ea.	48 Ea.	E0	
		10B	613	71443435		139.44	Ea	1Ea.	3 Ea.	48 Ea.	E0	
		3	605	71443402		143.27	Ea	1Ea.	3 Ea.	48 Ea.	E0	
		32D	630	71440114	✓	162.80	Ea	1Ea.	3 Ea.	48 Ea.	E0	
		630W	630W	71950278		145.20	Ea	1Ea.	3 Ea.	48 Ea.	E0	
		26D	626			171.36	Ea	1Ea.	3 Ea.	30 Ea.	E0	
	5"X4.5"	32D	630	71444340		196.19	Ea	1Ea.	3 Ea.	30 Ea.	E0	
		630W	630W	71950282		202.05	Ea	1Ea.	3 Ea.	48 Ea.	E0	
		10B	613	71447383		169.24	Ea	1Ea.	3 Ea.	30 Ea.	E0	
	5"X5"	10B	613	71443663		188.49	Ea	1Ea.	3 Ea.	30 Ea.	E0	
32D		630	71443782		208.69	Ea	1Ea.	3 Ea.	30 Ea.	E0		
3		605			184.84	Ea	1Ea.	3 Ea.	30 Ea.	E0		
 <b>CB191NRP</b> Brass, Bronze or Stainless Steel Full Mortise Standard Weight Hinge w/ Non-Removable Pin	35"X3.5"	3	605			126.86	Ea	1Ea.	3 Ea.	90 Ea.	E0	
		32D	630			120.10	Ea	1Ea.	3 Ea.	90 Ea.	E0	
	4.5"X4"	26D	626	71441258	✓	116.28	Ea	1Ea.	3 Ea.	48 Ea.	E0	
		626W	626W	71950285		119.49	Ea	1Ea.	3 Ea.	48 Ea.	E0	
		10B	613	71447266		118.20	Ea	1Ea.	3 Ea.	48 Ea.	E0	
		32D	630	71444161	✓	149.94	Ea	1Ea.	3 Ea.	48 Ea.	E0	
		630W	630W	71950286		153.78	Ea	1Ea.	3 Ea.	48 Ea.	E0	
	4.5"X4.5"	3	605	71447255		137.42	Ea	1Ea.	3 Ea.	48 Ea.	E0	
		26D	626	71443393		116.28	Ea	1Ea.	3 Ea.	48 Ea.	E0	
		626W	626W	71950284		119.49	Ea	1Ea.	3 Ea.	48 Ea.	E0	
		3	605	71443395		151.85	Ea	1Ea.	3 Ea.	48 Ea.	E0	
		10B	613	71443438		148.02	Ea	1Ea.	3 Ea.	48 Ea.	E0	
		32D	630	71440116	✓	171.38	Ea	1Ea.	3 Ea.	48 Ea.	E0	
		630W	630W	71950283		153.78	Ea	1Ea.	3 Ea.	48 Ea.	E0	
	5"X4.5"	32	629			139.53	Ea	1Ea.	3 Ea.	48 Ea.	E0	
		10	612	71443437		102.79	Ea	1Ea.	3 Ea.	48 Ea.	E0	
		32D	630	71444350	✓	204.77	Ea	1Ea.	3 Ea.	30 Ea.	E0	
		630W	630W	71950287		210.63	Ea	1Ea.	3 Ea.	48 Ea.	E0	
	<b>CECB191-12C</b> 12 Conductor Electrified Hinge w/ Quick Connect	4.5" X 4.5"	32D	630	71450101		801.37	Ea	1Ea.	1Ea.	5 Ea.	D4
			26D	626	71450081		677.40	Ea	1Ea.	1Ea.	5 Ea.	D4
			3	605	71450082		712.97	Ea	1Ea.	1Ea.	5 Ea.	D4
			4	606	71450083		677.40	Ea	1Ea.	1Ea.	5 Ea.	D4
			10B	613	71450084		709.14	Ea	1Ea.	1Ea.	5 Ea.	D4

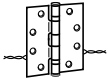
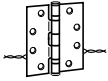

All prices are for items furnished with screws (as specified in catalog) unless otherwise stated in price list.  
 \* To price other finishes on architectural items – See pricing extras.

\*\* For conversion pins and decorative tips – See Miscellaneous Architectural Parts.  
 (X) Item must be ordered in these increments.

# Five Knuckle Architectural Hinges (cont.)



	Model	Size	Finish	BHMA	EDP #	Stock Item	List Price	UOM	Order Multiple	Box Qty	Carton Qty	MPG	
	<b>CECB191-18</b> Stainless Steel Full Mortise Standard Weight Concealed Conductor Hinge Spec. 8- wire	4.5"x4.5"	32D	630	711839258	✓	801.37	Ea	1Ea.	1Ea.	5 Ea.	D4	
		5"x4.5"	32D	630	711839266		834.76	Ea	1Ea.	1Ea.	5 Ea.	D4	
		<b>CECB191-54</b> Brass, Bronze or Stainless Steel Full Mortise Standard Weight Concealed Conductor Hinge 4- wire	4.5"x4.5"	32D	630	711440380		644.86	Ea	1Ea.	1Ea.	5	D4
	<b>CECB191-66</b> Brass, Bronze or Stainless Steel Full Mortise Standard Weight Concealed Conductor Hinge Spec. 6- wire	4.5"x4.5"	10	612	711440002		632.61	Ea	1Ea.	1Ea.	5	D4	
			10B	613	711440003		677.84	Ea	1Ea.	1Ea.	5	D4	
			26	625	711440005		681.67	Ea	1Ea.	1Ea.	5	D4	
			26D	626	711440001		646.10	Ea	1Ea.	1Ea.	5	D4	
			3	605	711440004		681.67	Ea	1Ea.	1Ea.	5	D4	
			5"x4.5"	26D	626	711440006		779.46	Ea	1Ea.	1Ea.	5	D4
	<b>F191</b> Brass, Bronze or Stainless Steel Full Mortise Standard Weight Hinge	3.5"x3.5"	26D	626	711036056		61.98	Ea	1Ea.	2 Ea.	100 Ea.	EO	
			10	612	711036086		54.77	Ea	1Ea.	2 Ea.	100 Ea.	EO	
			3	605	711036057		67.76	Ea	1Ea.	2 Ea.	100 Ea.	EO	
			10B	613	711036087	✓	67.76	Ea	1Ea.	2 Ea.	100 Ea.	EO	
			26	625	711036059		67.76	Ea	1Ea.	2 Ea.	100 Ea.	EO	
			32D	630	711037186		96.61	Ea	1Ea.	2 Ea.	100 Ea.	EO	
		4"x4"	P	600	711036147		60.57	Ea	1Ea.	3 Ea.	48 Ea.	EO	
			26D	626	711036118		66.34	Ea	1Ea.	3 Ea.	48 Ea.	EO	
			3	605	711036121		74.01	Ea	1Ea.	3 Ea.	48 Ea.	EO	
			10B	613	711036149	✓	74.01	Ea	1Ea.	3 Ea.	48 Ea.	EO	
			26	625	711036116		74.01	Ea	1Ea.	3 Ea.	48 Ea.	EO	
			32D	630	711034302	✓	95.20	Ea	1Ea.	3 Ea.	48 Ea.	EO	
		4.5"x4"	32	629	711034303		105.75	Ea	1Ea.	3 Ea.	48 Ea.	EO	
				32D	630	711037342		117.30	Ea	1Ea.	3 Ea.	48 Ea.	EO
		4.5"x4.5"	10	612	711033993		73.07	Ea	1Ea.	3 Ea.	48 Ea.	EO	
				4	606	711033963		73.07	Ea	1Ea.	3 Ea.	48 Ea.	EO
				26D	626	711033962		96.15	Ea	1Ea.	3 Ea.	48 Ea.	EO
				3	605	711033966		85.55	Ea	1Ea.	3 Ea.	48 Ea.	EO
			10B	613	711033994	✓	85.55	Ea	1Ea.	3 Ea.	48 Ea.	EO	
				32D	630	711037353	✓	123.07	Ea	1Ea.	3 Ea.	48 Ea.	EO
				32	629	711037351		135.59	Ea	1Ea.	3 Ea.	48 Ea.	EO
				3.5"x3.5"	10B	613	711036010		76.34	Ea	1Ea.	2 Ea.	100 Ea.
			4"x4"	3	605	711036055		76.34	Ea	1Ea.	2 Ea.	100 Ea.	EO
					26	625	711036011		76.34	Ea	1Ea.	2 Ea.	100 Ea.
32D	630				711037185		105.19	Ea	1Ea.	2 Ea.	100 Ea.	EO	
P	600				711033981		69.15	Ea	1Ea.	3 Ea.	48 Ea.	EO	
26D	626	711036143				74.92	Ea	1Ea.	3 Ea.	48 Ea.	EO		
3	605	711036140				82.59	Ea	1Ea.	3 Ea.	48 Ea.	EO		
10B	613	711036145			82.59	Ea	1Ea.	3 Ea.	48 Ea.	EO			
	26	625		711036115		82.59	Ea	1Ea.	3 Ea.	48 Ea.	EO		
	32	629		711034300		114.33	Ea	1Ea.	3 Ea.	48 Ea.	EO		
	4.5"x4.5"	10		612	711036246		81.65	Ea	1Ea.	3 Ea.	48 Ea.	EO	
				4	606	711033980		81.65	Ea	1Ea.	3 Ea.	48 Ea.	EO
		26D		626	711033974		104.73	Ea	1Ea.	3 Ea.	48 Ea.	EO	
3		605		711033970		94.13	Ea	1Ea.	3 Ea.	48 Ea.	EO		
10B		613		711036247		94.13	Ea	1Ea.	3 Ea.	48 Ea.	EO		
32D		630		711037362	✓	131.65	Ea	1Ea.	3 Ea.	48 Ea.	EO		
32	629	711033979			144.17	Ea	1Ea.	3 Ea.	48 Ea.	EO			

# Five Knuckle Architectural Hinges (cont.)

Model	Size	Finish	BHMA	EDP #	Stock Item	List Price	UOM	Order Multiple	Box Qty	Carton Qty	MPG	
 <b>FBB191</b> Brass, Bronze or Stainless Steel Full Mortise Standard Weight Hinge	3.5"x3.5"	3	605	711043334		118.28	Ea.	1Ea.	3 Ea.	90 Ea.	EO	
		32D	630	711043659		111.52	Ea.	1Ea.	3 Ea.	90 Ea.	EO	
		26D	626	711043335		58.64	Ea.	1Ea.	3 Ea.	90 Ea.	EO	
	4"x4"	3	605	711043364	✓	118.28	Ea.	1Ea.	3 Ea.	48 Ea.	EO	
		10B	613	711043374		84.61	Ea.	1Ea.	3 Ea.	48 Ea.	EO	
		26	625	711043363		123.07	Ea.	1Ea.	3 Ea.	48 Ea.	EO	
		32D	630	711040077	✓	128.84	Ea.	1Ea.	3 Ea.	48 Ea.	EO	
		26D	626	711043362		70.18	Ea.	1Ea.	3 Ea.	48 Ea.	EO	
		10	612	711043372		67.30	Ea.	1Ea.	3 Ea.	48 Ea.	EO	
		4.5"x4"	P	600	711047240		82.67	Ea.	1Ea.	3 Ea.	48 Ea.	EO
	10		612	711047202		94.21	Ea.	1Ea.	3 Ea.	48 Ea.	EO	
	4		606	711047237		94.21	Ea.	1Ea.	3 Ea.	48 Ea.	EO	
	19		622			102.69	Ea.	1Ea.	3 Ea.	48 Ea.	EO	
	26D		626	711047236	✓	107.70	Ea.	1Ea.	3 Ea.	48 Ea.	EO	
	15		619	711043814		118.28	Ea.	1Ea.	3 Ea.	48 Ea.	EO	
	3		605	711047238		128.84	Ea.	1Ea.	3 Ea.	48 Ea.	EO	
	32D		630	711044156		134.61	Ea.	1Ea.	3 Ea.	48 Ea.	EO	
	4.5"x4.5"		P	600	711043399		94.21	Ea.	1Ea.	3 Ea.	48 Ea.	EO
			4	606	711043403	✓	94.21	Ea.	1Ea.	3 Ea.	48 Ea.	EO
		10	612	711043422		94.21	Ea.	1Ea.	3 Ea.	48 Ea.	EO	
		26D	626	711043392	✓	96.88	Ea.	1Ea.	3 Ea.	48 Ea.	EO	
		26	625	711043389		107.70	Ea.	1Ea.	3 Ea.	48 Ea.	EO	
		3	605	711043402	✓	112.51	Ea.	1Ea.	3 Ea.	48 Ea.	EO	
		10B	613	711043435	✓	128.84	Ea.	1Ea.	3 Ea.	48 Ea.	EO	
		32	629	711040109		129.82	Ea.	1Ea.	3 Ea.	48 Ea.	EO	
		19	622	711950323	✓	150.98	Ea.	1Ea.	3 Ea.	48 Ea.	EO	
		32D	630	711040822	✓	134.61	Ea.	1Ea.	3 Ea.	48 Ea.	EO	
5"x4"	26D	626	711047343		132.71	Ea.	1Ea.	3 Ea.	30 Ea.	EO		
5"x4.5"	19	622			110.71	Ea.	1Ea.	3 Ea.	30 Ea.	EO		
	32D	630	711044340	✓	164.45	Ea.	1Ea.	3 Ea.	30 Ea.	EO		
	26D	626	711047412		123.07	Ea.	1Ea.	3 Ea.	30 Ea.	EO		
5"x5"	3	605	711043522		157.69	Ea.	1Ea.	3 Ea.	30 Ea.	EO		
	10B	613	711043663	✓	160.58	Ea.	1Ea.	3 Ea.	30 Ea.	EO		
	19	622			115.71	Ea.	1Ea.	3 Ea.	48 Ea.	EO		
	32D	630	711043782		169.24	Ea.	1Ea.	3 Ea.	30 Ea.	EO		
 <b>QKSFB191</b> By LOCKT Steel Adjustable Full Mortise Heavy Weight Hinge	4.5"x4.5"	26D	652	7265998		86.79	Ea.	30 Ea.	3 Ea.	30 Ea.	EO	

# Five Knuckle Architectural Hinges (cont.)

# Hinges & Door Accessories

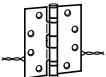
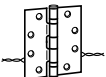

	Model	Size	Finish	BHMA	EDP #	Stock Item	List Price	UOM	Order Multiple	Box Qty	Carton Qty	MPG
	<b>FBB191NRP</b> Brass, Bronze or Stainless Steel Full Mortise Standard Weight Hinge w/ Non-Removable Pin	3.5"x3.5"	3	605	71043332		126.86	Ea	1Ea.	3 Ea.	90 Ea.	E0
			32D	630	71043655		120.10	Ea	1Ea.	3 Ea.	90 Ea.	E0
		4"x4"	3	605	71043367		126.86	Ea	1Ea.	3 Ea.	48 Ea.	E0
			10B	613	71043379		93.19	Ea	1Ea.	3 Ea.	48 Ea.	E0
			26	625	71043361		131.65	Ea	1Ea.	3 Ea.	48 Ea.	E0
			4	606	71047252		102.79	Ea	1Ea.	3 Ea.	48 Ea.	E0
		4.5"x4"	10	612	71047265		102.79	Ea	1Ea.	3 Ea.	48 Ea.	E0
			19	622			106.40	Ea	1Ea.	3 Ea.	48 Ea.	E0
			26D	626	71041258	✓	116.28	Ea	1Ea.	3 Ea.	48 Ea.	E0
			3	605	71047255		137.42	Ea	1Ea.	3 Ea.	48 Ea.	E0
		4.5"x4.5"	32D	630	71044161	✓	143.19	Ea	1Ea.	3 Ea.	48 Ea.	E0
			15	619	71043824		126.86	Ea	1Ea.	3 Ea.	48 Ea.	E0
			10B	613	71047266		139.53	Ea	1Ea.	3 Ea.	48 Ea.	E0
			P	600	71043394		102.79	Ea	1Ea.	3 Ea.	48 Ea.	E0
			4	606	71043396		102.79	Ea	1Ea.	3 Ea.	48 Ea.	E0
			10	612	71043438	✓	102.79	Ea	1Ea.	3 Ea.	48 Ea.	E0
			19	622	711950324	✓	106.40	Ea	1Ea.	3 Ea.	48 Ea.	E0
			26D	626	71043393	✓	111.27	Ea	1Ea.	3 Ea.	48 Ea.	E0
			3	605	71043395		121.09	Ea	1Ea.	3 Ea.	48 Ea.	E0
			26	625	71043401		116.28	Ea	1Ea.	3 Ea.	48 Ea.	E0
			10B	613	71043439	✓	137.42	Ea	1Ea.	3 Ea.	48 Ea.	E0
			32	629	71040115		138.40	Ea	1Ea.	3 Ea.	48 Ea.	E0
		5"x4.5"	32D	630	71040116	✓	143.19	Ea	1Ea.	3 Ea.	48 Ea.	E0
			32D	630	71044350	✓	173.03	Ea	1Ea.	3 Ea.	30 Ea.	E0
			19	622			109.86	Ea	1Ea.	3 Ea.	30 Ea.	E0
			26D	626	71047422		131.65	Ea	1Ea.	3 Ea.	30 Ea.	E0
		5"x5"	3	605	71043540		166.27	Ea	1Ea.	3 Ea.	30 Ea.	E0
			10B	613	71043667		169.16	Ea	1Ea.	3 Ea.	30 Ea.	E0
19	622				114.86	Ea	1Ea.	3 Ea.	30 Ea.	E0		
32D	630		71043780		177.82	Ea	1Ea.	3 Ea.	30 Ea.	E0		
	<b>FBB191NRP w/ SEC. ST.</b> Stainless Steel Full Mortise Standard Weight Hinge x Security Stud	4.5"x4.5"	32D	630	71068446		95.37	Ea	1Ea.	3 Ea.	30 Ea.	E0
	<b>QKSFBB191NRP</b> By LOCKT Steel Adjustable Full Mortise Heavy Weight Hinge	4.5"x4.5"	26D	652	7265999		165.86	Ea	30 Ea.	3 Ea.	30 Ea.	E0
	<b>CEFB191-54</b> Brass, Bronze or Stainless Steel Full Mortise Standard Weight Concealed Conductor Hinge 4- wire	4.5"x4.5"	32D	630	71040801		616.67	Ea	1Ea.	1Ea.	5 Ea.	D4
	<b>CEFB191-66</b> Brass, Bronze or Stainless Steel Full Mortise Standard Weight Concealed Conductor Hinge Spec. 6- wire	4.5"x4.5"	26D	626	71060106		641.10	Ea	1Ea.	1Ea.	5 Ea.	D4
		4.5"x4.5"	3	605	71060109		650.91	Ea	1Ea.	1Ea.	5 Ea.	D4

All prices are for items furnished with screws (as specified in catalog) unless otherwise stated in price list.  
\* To price other finishes on architectural items – See pricing extras.

\*\* For conversion pins and decorative tips – See Miscellaneous Architectural Parts.  
(X) Item must be ordered in these increments.

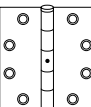

# Five Knuckle Architectural Hinges (cont.)





Model	Size	Finish	BHMA	EDP #	Stock Item	List Price	UOM	Order Multiple	Box Qty	Carton Qty	MPG	
 <b>CB199</b> Brass, Bronze or Stainless Steel Full Mortise Heavy Weight Hinge	4.5"x4"	32D	630	711444518	✓	260.63	Ea	1Ea.	3 Ea.	30 Ea.	E0	
		630W	630W	711950307		268.41	Ea	1Ea.	3 Ea.	30 Ea.	E0	
	4.5"x4.5"	10	612	711444932		190.42	Ea	1Ea.	3 Ea.	30 Ea.	E0	
		26D	626	711444992		208.69	Ea	1Ea.	3 Ea.	30 Ea.	E0	
		626W	626W	711950305		214.92	Ea	1Ea.	3 Ea.	30 Ea.	E0	
		10B	613			236.08	Ea	1Ea.	3 Ea.	30 Ea.	E0	
		32D	630	711444783	✓	268.33	Ea	1Ea.	3 Ea.	30 Ea.	E0	
		630W	630W	711950306		276.34	Ea	1Ea.	3 Ea.	30 Ea.	E0	
		32	629			280.59	Ea	1Ea.	3 Ea.	30 Ea.	E0	
	5"x4.5"	26D	626	711445073		233.70	Ea	1Ea.	3 Ea.	24 Ea.	E0	
		626W	626W	711950308		240.67	Ea	1Ea.	3 Ea.	24 Ea.	E0	
		10B	613	711445032		293.31	Ea	1Ea.	3 Ea.	24 Ea.	E0	
		32D	630	711445072	✓	310.63	Ea	1Ea.	3 Ea.	24 Ea.	E0	
		630W	630W	711950309		319.91	Ea	1Ea.	3 Ea.	24 Ea.	E0	
	5"x5"	10B	613	711445111		292.37	Ea	1Ea.	3 Ea.	24 Ea.	E0	
		3	605			283.08	Ea	1Ea.	3 Ea.	24 Ea.	E0	
		32D	630	711445125		303.91	Ea	1Ea.	3 Ea.	24 Ea.	E0	
	6"x4.5"	26D	626			389.41	Ea	1Ea.	3 Ea.	24 Ea.	E0	
	6"x5"	26D	626			389.41	Ea	1Ea.	3 Ea.	24 Ea.	E0	
	6"x6"	26D	626			389.41	Ea	1Ea.	3 Ea.	24 Ea.	E0	
 <b>CB199NRP</b> Brass, Bronze or Stainless Steel Full Mortise Heavy Weight Hinge w/ Non-Removable Pin	4.5"x4"	32D	630	711444520	✓	269.21	Ea	1Ea.	3 Ea.	30 Ea.	E0	
		630W	630W	711950312		276.99	Ea	1Ea.	3 Ea.	30 Ea.	E0	
	4.5"x4.5"	10	612	711444938		199.00	Ea	1Ea.	3 Ea.	30 Ea.	E0	
		26D	626	711444998	✓	217.27	Ea	1Ea.	3 Ea.	30 Ea.	E0	
		626W	626W	711950310		223.50	Ea	1Ea.	3 Ea.	30 Ea.	E0	
		10B	613	711444940		244.66	Ea	1Ea.	3 Ea.	30 Ea.	E0	
		32D	630	711444786	✓	276.91	Ea	1Ea.	3 Ea.	30 Ea.	E0	
		630W	630W	711950311		284.92	Ea	1Ea.	3 Ea.	30 Ea.	E0	
		32	629			289.17	Ea	1Ea.	3 Ea.	24 Ea.	E0	
	5"x4.5"	26D	626	711445045		242.28	Ea	1Ea.	3 Ea.	24 Ea.	E0	
		626W	626W	711950313		249.25	Ea	1Ea.	3 Ea.	24 Ea.	E0	
		32D	630	711444982	✓	319.21	Ea	1Ea.	3 Ea.	24 Ea.	E0	
		630W	630W	711950314		328.49	Ea	1Ea.	3 Ea.	24 Ea.	E0	
		32	629			289.17	Ea	1Ea.	3 Ea.	24 Ea.	E0	
		10B	613			301.89	Ea	1Ea.	3 Ea.	24 Ea.	E0	
	5"x5"	10B	613			300.95	Ea	1Ea.	3 Ea.	24 Ea.	E0	
		32D	630			312.49	Ea	1Ea.	3 Ea.	24 Ea.	E0	
	<b>CECB199-12C</b> 12 Conductor Electrified Hinge w/ Quick Connect	4.5"x4.5"	32D	630	711450091		906.90	Ea	1Ea.	1Ea.	5 Ea.	D4
		5" X 4.5"	32D	630	711450092		949.20	Ea	1Ea.	1Ea.	5 Ea.	D4
			10B	613	711450090		863.02	Ea	1Ea.	1Ea.	5 Ea.	D4
5" X 5"		26D	626	711450085		803.41	Ea	1Ea.	1Ea.	5 Ea.	D4	
		3	605	711450086		852.78	Ea	1Ea.	1Ea.	5 Ea.	D4	
		4	606	711450087		850.15	Ea	1Ea.	1Ea.	5 Ea.	D4	
		10B	613	711450088		862.08	Ea	1Ea.	1Ea.	5 Ea.	D4	
 <b>CECB199-18</b> Stainless Steel Full Mortise Heavy Weight Concealed Conductor Hinge Spec. 8- wire	4.5"x4.5"	32D	630	711839274	✓	906.90	Ea	1Ea.	1Ea.	5 Ea.	D4	
	5"x4.5"	32D	630	711839282		949.20	Ea	1Ea.	1Ea.	5 Ea.	D4	
 <b>CECB199-54</b> Brass, Bronze or Stainless Steel Full Mortise Heavy Weight Concealed Conductor Hinge 4- wire	4.5"x4.5"	26D	626	711440382		621.88	Ea	1Ea.	1Ea.	5 Ea.	D4	
	4.5"x4.5"	32D	630	711440381		750.39	Ea	1Ea.	1Ea.	5 Ea.	D4	

All prices are for items furnished with screws (as specified in catalog) unless otherwise stated in price list.  
 \* To price other finishes on architectural items – See pricing extras.





\*\* For conversion pins and decorative tips – See Miscellaneous Architectural Parts.  
 (X) Item must be ordered in these increments.

# Five Knuckle Architectural Hinges (cont.)

## Hinges & Door Accessories



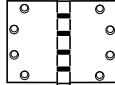

	Model	Size	Finish	BHMA	EDP #	Stock Item	List Price	UOM	Order Multiple	Box Qty	Carton Qty	MPG
	<b>IHTCB199 N/SRS</b>	4.5 x 4.5	P		711455152		234.66	Ea.	1 Ea.	3 Ea.	30 Ea.	E0
	Stainless Steel Full Mortise Heavy Weight with Institutional Hospital Tip Hinge	4.5"x4.5"	32D	630	711445490		279.87	Ea.	1 Ea.	3 Ea.	30 Ea.	E0
		5"x4.5"	32D	630	711925500		322.17	Ea.	1 Ea.	3 Ea.	24 Ea.	E0
	<b>IHTCB199 SRS</b>	4.5"x4.5"	32D	630	711925491		272.17	Ea.	1 Ea.	3 Ea.	24 Ea.	E0
	Stainless Steel Full Mortise Heavy Weight with Institutional Hospital Tip Hinge and Sheer Resistant Stud	5"x4.5"	32D	630	711925494		322.17	Ea.	1 Ea.	3 Ea.	24 Ea.	E0
	<b>CEFBB199-54</b>	4.5"x4.5"	32D	630	711040802		711.89	Ea.	1 Ea.	1 Ea.	5	D4
	Stainless Steel Full Mortise Heavy Weight Concealed Conductor Hinge 4- wire											
	<b>FBB199</b> Brass, Bronze or Stainless Steel Full Mortise Heavy Weight Hinge	4.5"x4"	19	622			165.23	Ea.	1 Ea.	3 Ea.	30 Ea.	E0
			26D	626	711044503		183.66	Ea.	1 Ea.	3 Ea.	15 Ea.	E0
			32D	630	711044518	✓	217.35	Ea.	1 Ea.	3 Ea.	30 Ea.	E0
		4.5"x4.5"	10	612	711044932	✓	173.11	Ea.	1 Ea.	3 Ea.	30 Ea.	E0
			19	622			165.23	Ea.	1 Ea.	3 Ea.	30 Ea.	E0
			26D	626	711044992	✓	189.43	Ea.	1 Ea.	3 Ea.	30 Ea.	E0
			4	606	711044997		175.99	Ea.	1 Ea.	3 Ea.	30 Ea.	E0
			10B	613	711044933		216.39	Ea.	1 Ea.	3 Ea.	30 Ea.	E0
			3	605	711044994		216.39	Ea.	1 Ea.	3 Ea.	30 Ea.	E0
			32D	630	711044783	✓	229.83	Ea.	1 Ea.	3 Ea.	30 Ea.	E0
		5"x4.5"	32	629	711044784		252.92	Ea.	1 Ea.	3 Ea.	30 Ea.	E0
			19	622			192.92	Ea.	1 Ea.	3 Ea.	24 Ea.	E0
			26D	626	711045032		214.46	Ea.	1 Ea.	3 Ea.	24 Ea.	E0
			32D	630	711045073	✓	258.69	Ea.	1 Ea.	3 Ea.	24 Ea.	E0
32	629		711045074		309.68	Ea.	1 Ea.	3 Ea.	24 Ea.	E0		
3	605		711045094		247.15	Ea.	1 Ea.	3 Ea.	24 Ea.	E0		
5"x5"	10B	613	711045111		247.15	Ea.	1 Ea.	3 Ea.	24 Ea.	E0		
	19	622			197.92	Ea.	1 Ea.	3 Ea.	24 Ea.	E0		
	10	612	711045186		328.93	Ea.	1 Ea.	3 Ea.	24 Ea.	E0		
6"x5"	26D	626	711045162		356.80	Ea.	1 Ea.	3 Ea.	24 Ea.	E0		
	32D	630	711045207		481.86	Ea.	1 Ea.	3 Ea.	24 Ea.	E0		
	<b>OKSFBB199</b>	4.5"x4.5"	32D	630	7266000		152.39	Ea.	30 Ea.	3 Ea.	30 Ea.	E0
	By LOCKT Stainless Steel Adjustable Full Mortise Heavy Weight Hinge											

# Five Knuckle Architectural Hinges (cont.)

	Model	Size	Finish	BHMA	EDP #	Stock Item	List Price	UOM	Order Multiple	Box Qty	Carton Qty	MPG				
	<b>FBB199NRP</b> Brass, Bronze or Stainless Steel Full Mortise Heavy Weight Hinge w/ Non-Removable Pin	4.5"X4"	19	622			170.41	Ea.	1Ea.	3 Ea.	30 Ea.	EO				
			26D	626	711044504	✓	192.24	Ea.	1Ea.	3 Ea.	30 Ea.	EO				
			32D	630	711044520	✓	225.93	Ea.	1Ea.	3 Ea.	30 Ea.	EO				
	4.5"X4.5"			10	612	711044938		181.69	Ea.	1Ea.	3 Ea.	30 Ea.	EO			
				19	622			170.41	Ea.	1Ea.	3 Ea.	30 Ea.	EO			
				26D	626	711044998	✓	198.01	Ea.	1Ea.	3 Ea.	30 Ea.	EO			
				4	606	711044950		184.57	Ea.	1Ea.	3 Ea.	30 Ea.	EO			
				10B	613	711044940	✓	224.97	Ea.	1Ea.	3 Ea.	30 Ea.	EO			
				3	605	711044991		224.97	Ea.	1Ea.	3 Ea.	30 Ea.	EO			
				32	629	711044781		261.50	Ea.	1Ea.	3 Ea.	30 Ea.	EO			
				32D	630	711044786	✓	238.41	Ea.	1Ea.	3 Ea.	30 Ea.	EO			
				5"x4.5"			19	622			202.45	Ea.	1Ea.	3 Ea.	24 Ea.	EO
							26D	626	711045045	✓	223.04	Ea.	1Ea.	3 Ea.	24 Ea.	EO
	10B	613	711048039					267.65	Ea.	1Ea.	3 Ea.	24 Ea.	EO			
	32D	630	711044982				✓	267.27	Ea.	1Ea.	3 Ea.	24 Ea.	EO			
	5"x5"			32	629	711045071		318.26	Ea.	1Ea.	3 Ea.	24 Ea.	EO			
				3	605	711045101		255.73	Ea.	1Ea.	3 Ea.	24 Ea.	EO			
				10B	613	711045119		255.73	Ea.	1Ea.	3 Ea.	24 Ea.	EO			
				19	622			207.45	Ea.	1Ea.	3 Ea.	24 Ea.	EO			
				32D	630	711045122	✓	306.87	Ea.	1Ea.	3 Ea.	24 Ea.	EO			
	<b>QKSFB199NRP</b> By LOCKT Stainless Steel Adjustable Full Mortise Heavy Weight Hinge w/ Non-Removable Pin	4.5"X4.5"	32D	630	7266001		152.34	Ea.	30 Ea.	3 Ea.	30 Ea.	EO				
	<b>FBB199WT</b> Brass, Bronze or Stainless Steel Wide Throw Steel Full Mortise Heavy Weight Hinge	4.5"x6"					Price on Application									
	<b>BB1409</b>	4.5" x 4"	26D	-	700063354	✓	22.20	Ea.	1Ea.	3 Ea.	48 Ea.	-				
	<b>BB1409NRP</b>	4.5" x 4"	26D	-	700063358	✓	22.89	Ea.	1Ea.	3 Ea.	48 Ea.	-				

# Pivot Reinforced Hinges





# Hinges & Door Accessories

	Model	Size	Finish	BHMA	EDP #	Stock Item	List Price	UOM	Order Multiple	Box Qty	Carton Qty	MPG		
 <p>Must be ordered as a complete set.</p>	<b>CB211 LH</b> Steel Pivot-Reinforced Heavy Weight Hinge for Square or Beveled Edge Doors	5"x4.5"	26D	652			760.18	Set	1Set	1Set	1Set	EO		
		5"x4.5"	P	600			663.73	Set	1Set	1Set	1Set	EO		
		<b>CB211 RH</b> Steel Pivot-Reinforced Heavy Weight Hinge for Square or Beveled Edge Doors	5"x4.5"	26D	652			760.18	Set	1Set	1Set	1Set	EO	
			5"x4.5"	P	600			663.73	Set	1Set	1Set	1Set	EO	
	 <p>Must be ordered as a complete set.</p>	<b>FBB211 LH</b> Steel Pivot-Reinforced Heavy Weight Hinge for Square or Beveled Edge Doors	5"x4.5"	26D	652	711061426		698.17	Set	1Set	1Set	1Set	EO	
			<b>FBB211 RH</b> Steel Pivot-Reinforced Heavy Weight Hinge for Square or Beveled Edge Doors	5"x4.5"	26D	652	711061436		698.17	Set	1Set	1Set	1Set	EO
 <p>Must be ordered as a complete set.</p>		<b>CB212 LH</b> Steel Pivot-Reinforced Heavy Weight Hinge for Square Edge Doors	5"x4.5"	26D	652	711441867		326.25	Set	1Set	1Set	1Set	EO	
				5"x4.5"	P	600		663.73	Set	1Set	1Set	1Set	EO	
			<b>CB212 RH</b> Steel Pivot-Reinforced Heavy Weight Hinge for Square Edge Doors	5"x4.5"	26D	652	711441868		326.25	Set	1Set	1Set	1Set	EO
				5"x4.5"	P	600			663.73	Set	1Set	1Set	1Set	EO
	 <p>Must be ordered as a complete set.</p>	<b>FBB212 LH</b> Steel Pivot-Reinforced Heavy Weight Hinge for Square Edge Doors	5"x4.5"	P	600	711061514		600.67	Set	1Set	1Set	1Set	EO	
				5"x4.5"	10	639	711061515		605.83	Set	1Set	1Set	1Set	EO
			5"x4.5"	26D	652	711061516		715.48	Set	1Set	1Set	1Set	EO	
		<b>FBB212 RH</b> Steel Pivot-Reinforced Heavy Weight Hinge for Square Edge Doors	5"x4.5"	P	600	711061524		600.67	Set	1Set	1Set	1Set	EO	
			5"x4.5"	10	639	711061529		605.83	Set	1Set	1Set	1Set	EO	
			5"x4.5"	26D	652	711061527		715.48	Set	1Set	1Set	1Set	EO	
 <p>Must be ordered as a complete set.</p>	<b>CB213 LH</b> Steel Pivot-Reinforced Heavy Weight Hinge for Beveled Edge Doors	5"x4.5"	P	600			667.45	Set	1Set	1Set	1Set	EO		
			5"x4.5"	26D	652	711441869		767.59	Set	1Set	1Set	1Set	EO	
		<b>CB213 RH</b> Steel Pivot-Reinforced Heavy Weight Hinge for Beveled Edge Doors	5"x4.5"	P	600			667.45	Set	1Set	1Set	1Set	EO	
			5"x4.5"	26D	652	711441870		767.59	Set	1Set	1Set	1Set	EO	

All prices are for items furnished with screws (as specified in catalog) unless otherwise stated in price list.  
 \* To price other finishes on architectural items – See pricing extras.

\*\* For conversion pins and decorative tips – See Miscellaneous Architectural Parts.  
 (X) Item must be ordered in these increments.

# Pivot Reinforced Hinges (cont.)



	Model	Size	Finish	BHMA	EDP #	Stock Item	List Price	UOM	Order Multiple	Box Qty	Carton Qty	MPG
 <p>Must be ordered as a complete set.</p>	<b>FBB213 LH</b> Steel Pivot-Reinforced Heavy Weight Hinge for Beveled Edge Doors	5"x4.5"	P	600	711061564		686.63	Set	1Set	1Set	1Set	EO
		5"x4.5"	26D	652	711061566		782.43	Set	1Set	1Set	1Set	EO
	<b>FBB213 RH</b> Steel Pivot-Reinforced Heavy Weight Hinge for Beveled Edge Doors	5"x4.5"	P	600	711061573		686.63	Set	1Set	1Set	1Set	EO
		5"x4.5"	26D	652	711061576		782.43	Set	1Set	1Set	1Set	EO
 <p>Must be ordered as a complete set.</p>	<b>CB221 LH</b> Bronze or Stainless Steel Pivot-Reinforced Heavy Weight Hinge for Square or Beveled Edge Doors	5"x4.5"	26D	626			982.71	Set	1Set	1Set	1Set	EO
		<b>CB221 RH</b> Bronze or Stainless Steel Pivot-Reinforced Heavy Weight Hinge for Square or Beveled Edge Doors	5"x4.5"	26D	626		982.71	Set	1Set	1Set	1Set	EO
 <p>Must be ordered as a complete set.</p>	<b>FBB221 LH</b> Bronze or Stainless Steel Pivot-Reinforced Heavy Weight Hinge for Square or Beveled Edge Doors	5"x4.5"	26D	626	711041761		989.61	Set	1Set	1Set	1Set	EO
		<b>FBB221 RH</b> Bronze or Stainless Steel Pivot-Reinforced Heavy Weight Hinge for Square or Beveled Edge Doors	5"x4.5"	26D	626	711041586		989.61	Set	1Set	1Set	1Set
 <p>Must be ordered as a complete set.</p>	<b>CB222 LH</b> Bronze or Stainless Steel Pivot-Reinforced Heavy Weight Hinge for Square Edge Doors	5"x4.5"	26D	626			982.71	Set	1Set	1Set	1Set	EO
		<b>CB222 RH</b> Bronze or Stainless Steel Pivot-Reinforced Heavy Weight Hinge for Square Edge Doors	5"x4.5"	26D	626		982.71	Set	1Set	1Set	1Set	EO
 <p>Must be ordered as a complete set.</p>	<b>FBB222 LH</b> Bronze or Stainless Steel Pivot-Reinforced Heavy Weight Hinge for Square Edge Doors	5"x4.5"	26D	626	711041608		989.61	Set	1Set	1Set	1Set	EO
		<b>FBB222 RH</b> Bronze or Stainless Steel Pivot-Reinforced Heavy Weight Hinge for Square Edge Doors	5"x4.5"	26D	626	711041613		989.61	Set	1Set	1Set	1Set

All prices are for items furnished with screws (as specified in catalog) unless otherwise stated in price list.  
 \* To price other finishes on architectural items – See pricing extras.

\*\* For conversion pins and decorative tips – See Miscellaneous Architectural Parts.  
 (X) Item must be ordered in these increments.

# Pivot Reinforced Hinges (cont.)



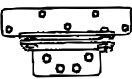







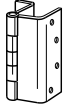

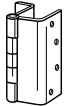

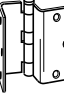

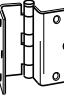

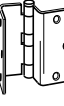

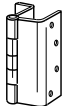

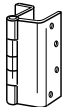
## Hinges & Door Accessories

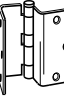
	Model	Size	Finish	BHMA	EDP #	Stock Item	List Price	UOM	Order Multiple	Box Qty	Carton Qty	MPG	
 <p>Must be ordered as a complete set.</p>	<b>CB223 LH</b> Bronze or Stainless Steel Pivot-Reinforced Heavy Weight Hinge for Beveled Edge Doors	5"x4.5"	26D	626	711441871		989.61	Set	1Set	1Set	1Set	EO	
		5"x4.5"	32D	630	711441865		1211.80	Set	1Set	1Set	1Set	EO	
	<b>CB223 RH</b> Bronze or Stainless Steel Pivot-Reinforced Heavy Weight Hinge for Beveled Edge Doors	5"x4.5"	26D	626	711441872		989.61	Set	1Set	1Set	1Set	EO	
		5"x4.5"	32D	630	711441866		1211.80	Set	1Set	1Set	1Set	EO	
	 <p>Must be ordered as a complete set.</p>	<b>FBB223 LH</b> Bronze or Stainless Steel Pivot-Reinforced Heavy Weight Hinge for Beveled Edge Doors	5"x4.5"	26D	626	711041619		989.61	Set	1Set	1Set	1Set	EO
			5"x4.5"	10B	613	711041620		923.24	Set	1Set	1Set	1Set	EO
5"x4.5"			32D	630	711041865		1211.80	Set	1Set	1Set	1Set	EO	
<b>FBB223 RH</b> Bronze or Stainless Steel Pivot-Reinforced Heavy Weight Hinge for Beveled Edge Doors		5"x4.5"	26D	626	711041621		989.61	Set	1Set	1Set	1Set	EO	
		5"x4.5"	10B	613	711041622		923.24	Set	1Set	1Set	1Set	EO	
		5"x4.5"	32D	630	711041881		1211.80	Set	1Set	1Set	1Set	EO	
	<b>225R</b> Reversible Shock Arrester		26D		711041662	✓	190.31	Set	1Set	1Set	10 Sets		
			P		711041661		170.11	Set	1Set	1Set	10 Sets		
			2C		711041782		161.45	Set	1Set	1Set	10 Sets		

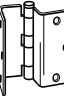
All prices are for items furnished with screws (as specified in catalog) unless otherwise stated in price list.  
 \* To price other finishes on architectural items – See pricing extras.

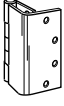
\*\* For conversion pins and decorative tips – See Miscellaneous Architectural Parts.  
 (X) Item must be ordered in these increments.

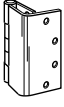
# Five Knuckle Swing Clear Hinges

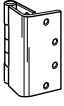



	Model	Size	Finish	BHMA	EDP #	Stock Item	List Price	UOM	Order Multiple	Box Qty	Carton Qty	MPG	
		<b>CB248</b>	4.5"	26D	652	711458860	139.44	Ea.	1Ea.	3 Ea.	24 Ea.	EO	
		Steel Full Mortise Swing-Clear Standard Weight Hinge for Square Edge Doors	4.5"	P	600			227.57	Ea.	1Ea.	3 Ea.	24 Ea.	EO
		<b>STSCB248</b>	4.5"	32D	630		274.10	Ea.	1Ea.	3 Ea.	24 Ea.	EO	
		Stainless Steel Full Mortise Swing-Clear Standard Weight Hinge for Square Edge Doors											
		<b>F248</b>	3.5"	P	600	711054501	✓	79.30	Ea.	1Ea.	2 Ea.	20 Ea.	EO
		Steel Full Mortise Standard Weight Swing-Clear Hinge for Square Edge Doors	3.5"	4	633	711054503	✓	83.63	Ea.	1Ea.	2 Ea.	20 Ea.	EO
			3.5"	26D	652	711054505	✓	93.73	Ea.	1Ea.	2 Ea.	20 Ea.	EO
			3.5"	3	632	711054509		115.37	Ea.	1Ea.	2 Ea.	20 Ea.	EO
			4"	4	633	711055152	✓	92.28	Ea.	1Ea.	2 Ea.	20 Ea.	EO
			4"	26D	652	711055154	✓	99.50	Ea.	1Ea.	2 Ea.	20 Ea.	EO
		<b>FBB248</b>	4.5"	26D	652	711068860	✓	139.44	Ea.	1Ea.	3 Ea.	24 Ea.	EO
		Steel Full Mortise Standard Weight Swing-Clear Hinge for Square Edge Doors	4.5"	P	600	711068950		183.66	Ea.	1Ea.	3 Ea.	24 Ea.	EO
		<b>STSFBB248</b>	4.5"	32D	630		255.80	Ea.	1Ea.	3 Ea.	24 Ea.	EO	
		Stainless Steel Steel Full Mortise Standard Weight for Swing-Clear Hinge Square Edge Doors											
		<b>CB258</b>	4.5"	P	600		227.57	Ea.	1Ea.	3 Ea.	24 Ea.	EO	
		Steel Full Mortise Standard Weight Swing-Clear Hinge for 1/8" in 2" beveled edge doors	4.5"	26D	652			247.27	Ea.	1Ea.	3 Ea.	24 Ea.	EO
		<b>STSCB258</b>	4.5"	32D	630		274.10	Ea.	1Ea.	3 Ea.	24 Ea.	EO	
		Stainless Steel Full Mortise Standard Weight Swing-Clear Hinge for 1/8" in 2" beveled edge doors											
		<b>FBB258</b>	4.5"	26D	652	711068960	✓	139.44	Ea.	1Ea.	3 Ea.	24 Ea.	EO
		Steel Full Mortise Standard Weight Swing-Clear Hinge for 1/8" in 2" beveled edge doors	4.5"	P	600	711068956		126.94	Ea.	1Ea.	3 Ea.	24 Ea.	EO
			4.5"	10	639	711068959		139.44	Ea.	1Ea.	3 Ea.	24 Ea.	EO
			4.5"	10A	641			279.87	Ea.	1Ea.	3 Ea.	24 Ea.	EO
		<b>STSFBB258</b>	4.5"	32D	630		255.80	Ea.	1Ea.	3 Ea.	24 Ea.	EO	
		Stainless Steel Full Mortise Standard Weight Swing-Clear Hinge for 1/8" in 2" beveled edge doors											
		<b>CB264</b>	5"	26D	652		309.03	Ea.	1Ea.	3 Ea.	15 Ea.	EO	
		Steel Half Mortise Swing-Clear Heavy Weight Hinge for Square Edge Doors											
		<b>STSCB264</b>	5"	32D	630		332.77	Ea.	1Ea.	3 Ea.	15 Ea.	EO	
		Stainless Steel Half Mortise Swing-Clear Heavy Weight Hinge for Square Edge Doors											
		<b>FBB264</b>	5"	26D	652	711069401		306.80	Ea.	1Ea.	3 Ea.	15 Ea.	EO
		Steel Half Mortise Swing-Clear Heavy Weight Hinge for Square Edge Doors											

All prices are for items furnished with screws (as specified in catalog) unless otherwise stated in price list.  
 \* To price other finishes on architectural items – See pricing extras.

\*\* For conversion pins and decorative tips – See Miscellaneous Architectural Parts.  
 (X) Item must be ordered in these increments.

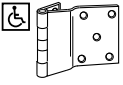
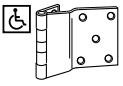
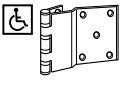
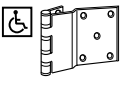
# Five Knuckle Swing Clear Hinges (cont.)

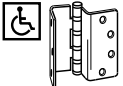
# Hinges & Door Accessories

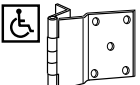
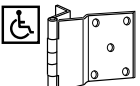
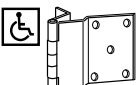











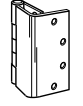

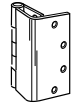

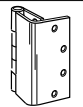
	Model	Size	Finish	BHMA	EDP #	Stock Item	List Price	UOM	Order Multiple	Box Qty	Carton Qty	MPG
	<b>STSFBB264</b> Stainless Steel Half Mortise Swing-Clear Heavy Weight Hinge for Square Edge Doors	5"	32D	630			319.28	Ea.	1Ea.	3 Ea.	15 Ea.	EO
	<b>CB266</b> Steel Full Surface Swing-Clear Heavy Weight Hinge	5"	P	600	711459517		268.33	Ea.	1Ea.	3 Ea.	15 Ea.	EO
	<b>STSCB266</b> Stainless Steel Full Surface Swing-Clear Heavy Weight Hinge	5"	32D	630			387.59	Ea.	1Ea.	3 Ea.	15 Ea.	EO
	<b>FBB266</b> Steel Full Surface Swing-Clear Heavy Weight Hinge	5"	26D	652	711069520		284.66	Ea.	1Ea.	3 Ea.	15 Ea.	EO
	<b>STSFBB266</b> Stainless Steel Full Surface Swing-Clear Heavy Weight Hinge	5"	32D	630			367.40	Ea.	1Ea.	3 Ea.	15 Ea.	EO
	<b>CB268</b> Steel Full Mortise Swing-Clear Heavy Weight Hinge for Square Edge Doors	4.5" 4.5" 5" 5"	P 26D 26D 10	600 652 652 639	  711450018 711450024		275.65 327.94 327.94 322.17	Ea. Ea. Ea. Ea.	1Ea. 1Ea. 1Ea. 1Ea.	3 Ea. 3 Ea. 3 Ea. 3 Ea.	15 Ea. 15 Ea. 15 Ea. 15 Ea.	EO EO EO EO
	<b>STSCB268</b> Stainless Steel Full Surface Swing-Clear Heavy Weight Hinge for Square Edge Doors	4.5" 5"	32D 32D	630 630			353.91 383.75	Ea. Ea.	1Ea. 1Ea.	3 Ea. 3 Ea.	15 Ea. 15 Ea.	EO EO
	<b>FBB268</b> Steel Full Mortise Swing-Clear Heavy Weight Hinge for Square Edge Doors	4.5" 4.5" 4.5" 5" 5" 5"	26D P 10 26D P 10	652 600 639 652 600 639	711060011 711060008 711060010 711060018 711060017 711060024	✓	303.91 288.53 301.03 303.91 291.41 301.03	Ea. Ea. Ea. Ea. Ea. Ea.	1Ea. 1Ea. 1Ea. 1Ea. 1Ea. 1Ea.	3 Ea. 3 Ea. 3 Ea. 3 Ea. 3 Ea. 3 Ea.	15 Ea. 15 Ea. 15 Ea. 15 Ea. 15 Ea. 15 Ea.	EO EO EO EO EO EO
	<b>STSFBB268</b> Stainless Steel Full Mortise Swing-Clear Heavy Weight Hinge for Square Edge Doors	4.5" 5"	32D 32D	630 630			341.43 371.22	Ea. Ea.	1Ea. 1Ea.	3 Ea. 3 Ea.	15 Ea. 15 Ea.	EO EO
	<b>CB269</b> Steel Half Surface Swing-Clear Heavy Weight Hinge	5" 5"	P 26D	600 652			265.75 315.23	Ea. Ea.	1Ea. 1Ea.	3 Ea. 3 Ea.	3 Ea. 3 Ea.	EO EO
	<b>STSCB269</b> Stainless Steel Half Surface Swing-Clear Heavy Weight Hinge	5"	32D	630			425.25	Ea.	1Ea.	3 Ea.	3 Ea.	EO
	<b>FBB269</b> Steel Half Surface Swing-Clear Heavy Weight Hinge	5" 5"	26D P	652 600	711060021 711060085		303.91 288.53	Ea. Ea.	1Ea. 1Ea.	3 Ea. 3 Ea.	3 Ea. 3 Ea.	EO EO

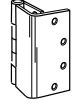
All prices are for items furnished with screws (as specified in catalog) unless otherwise stated in price list.  
 \* To price other finishes on architectural items – See pricing extras.

\*\* For conversion pins and decorative tips – See Miscellaneous Architectural Parts.  
 (X) Item must be ordered in these increments.

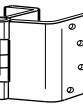

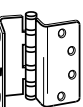
# Five Knuckle Swing Clear Hinges (cont.)

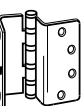



	Model	Size	Finish	BHMA	EDP #	Stock Item	List Price	UOM	Order Multiple	Box Qty	Carton Qty	MPG
	 <b>STSFB269</b> Stainless Steel Half Surface Swing-Clear Heavy Weight Hinge	5"	32D	630			417.39	Ea.	1Ea.	3 Ea.	3 Ea.	EO
	 <b>CB274</b> Steel Half Mortise Swing-Clear Heavy Weight Hinge for 1/8" in 2" beveled edge doors	5"	P	600			315.23	Ea.	1Ea.	3 Ea.	15 Ea.	EO
	 <b>STSCB274</b> Stainless Steel Half Mortise Swing-Clear Heavy Weight Hinge for 1/8" in 2" beveled edge doors	5"	32D	630			332.77	Ea.	1Ea.	3 Ea.	15 Ea.	EO
	 <b>FBB274</b> Steel Half Mortise Swing-Clear Heavy Weight Hinge for 1/8" in 2" beveled edge doors	5"	P	600	711069403		288.53	Ea.	1Ea.	3 Ea.	15 Ea.	EO
		5"	26D	652	711069410		298.14	Ea.	1Ea.	3 Ea.	15 Ea.	EO
	 <b>STSFB274</b> Stainless Steel Half Mortise Swing-Clear Heavy Weight Hinge for 1/8" in 2" beveled edge doors	5"	32D	630			318.90	Ea.	1Ea.	3 Ea.	15 Ea.	EO
	 <b>CB278</b> Steel Full Mortise Swing-Clear Heavy Weight Hinge for 1/8 in 2" beveled edge doors	4.5"	26D	652	711450042	✓	293.31	Ea.	1Ea.	3 Ea.	15 Ea.	EO
		4.5"	P	600			275.65	Ea.	1Ea.	3 Ea.	15 Ea.	EO
		5"	26D	652	711450027	✓	303.91	Ea.	1Ea.	3 Ea.	15 Ea.	EO
		5"	10	639	711450047		301.97	Ea.	1Ea.	3 Ea.	15 Ea.	EO
	 <b>STSCB278</b> Stainless Steel Full Mortise Swing-Clear Heavy Weight Hinge for 1/8 in 2" beveled edge doors	4.5"	32D	630			353.91	Ea.	1Ea.	3 Ea.	15 Ea.	EO
		5"	32D	630			391.42	Ea.	1Ea.	3 Ea.	15 Ea.	EO
	 <b>FBB278</b> Steel Full Mortise Swing-Clear Heavy Weight Hinge for 1/8 in 2" beveled edge doors	4.5"	26D	652	711060042	✓	301.97	Ea.	1Ea.	3 Ea.	15 Ea.	EO
		4.5"	P	600	711060038		276.99	Ea.	1Ea.	3 Ea.	15 Ea.	EO
		4.5"	10	639	711060041		293.31	Ea.	1Ea.	3 Ea.	15 Ea.	EO
		5"	26D	652	711060027	✓	301.97	Ea.	1Ea.	3 Ea.	15 Ea.	EO
		5"	P	600	711060026		276.99	Ea.	1Ea.	3 Ea.	15 Ea.	EO
	 <b>STSFB278</b> Steel Full Mortise Swing-Clear Heavy Weight Hinge for 1/8 in 2" beveled edge doors	4.5"	32D	630			341.43	Ea.	1Ea.	3 Ea.	15 Ea.	EO
		5"	32D	630			371.22	Ea.	1Ea.	3 Ea.	15 Ea.	EO

All prices are for items furnished with screws (as specified in catalog) unless otherwise stated in price list.  
 \* To price other finishes on architectural items – See pricing extras.

\*\* For conversion pins and decorative tips – See Miscellaneous Architectural Parts.  
 (X) Item must be ordered in these increments.

# Wardrobe Pivots

# Hinges & Door Accessories

	Model	Finish	BHMA	EDP #	Stock Item	List Price	UOM	Order Multiple	Box Qty	Carton Qty	MPG
	<b>327</b> Heavy Wardrobe Pivot for Doors 1-3/8"-1-3/4" up to 150 lbs.	26D		711350043	✓	118.20	Set	1 Set	1 Set	20 Sets	E6
		P				105.66	Set	1 Set	1 Set	20 Sets	E6
		3				128.34	Set	1 Set	1 Set	20 Sets	E6
		26				128.34	Set	1 Set	1 Set	20 Sets	E6
		10BL				128.34	Set	1 Set	1 Set	20 Sets	E6
		10				109.44	Set	1 Set	1 Set	20 Sets	E6
	<b>340 LH</b> LH Wardrobe Pivot for Flush Recessed or Overlay Doors 1-1/8"-1-3/8" Handed	26D		711350167	✓	66.23	Set	1 Set	1 Set	20 Sets	E6
		3		711350172		132.60	Set	1 Set	1 Set	20 Sets	E6
	<b>340 RH</b> RH Wardrobe Pivot for Flush Recessed or Overlay Doors 1-1/8"-1-3/8" Handed	26D		711350158	✓	66.23	Set	1 Set	1 Set	20 Sets	E6
		3		711350170		132.60	Set	1 Set	1 Set	20 Sets	E6
	<b>341 LH</b> LH Wardrobe Pivot for Flush Recessed or Overlay Doors 1-1/8"-1-3/8" Handed	26D		711350268	✓	74.89	Set	1 Set	1 Set	20 Sets	E6
		3		711350267		144.41	Set	1 Set	1 Set	20 Sets	E6
	<b>341 RH</b> RH Wardrobe Pivot for Flush Recessed or Overlay Doors 1-1/8"-1-3/8" Handed	26D		711350259	✓	72.14	Set	1 Set	1 Set	20 Sets	E6
		3		711350257		144.41	Set	1 Set	1 Set	20 Sets	E6
	<b>342</b> Wardrobe Pivot for Overlay Doors 1-1/8"-1-3/8"	26D		711350219	✓	80.66	Set	1 Set	1 Set	20 Sets	E6
		3		711350220		164.34	Set	1 Set	1 Set	20 Sets	E6

# EDGE GUARD SPECIAL ORDER FORM

Customer Account Number	For Office Use	Customer P.O. Number	Customer P.O. Date	Requested Ship Date

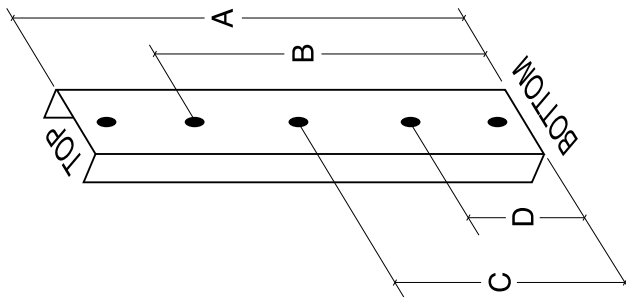

Standard Models Available

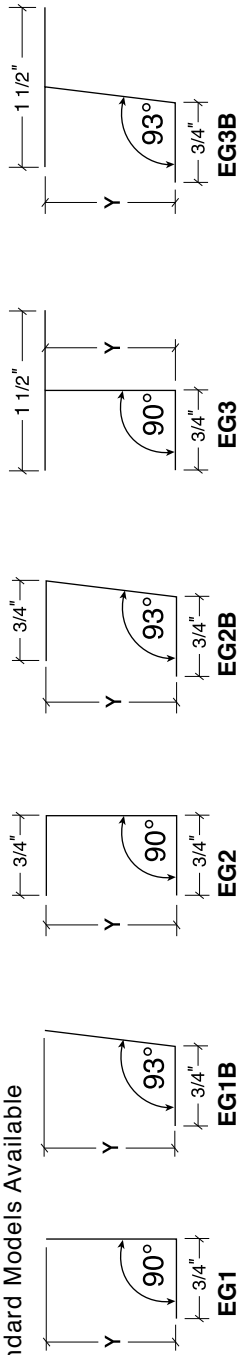

Standard Cutouts Available

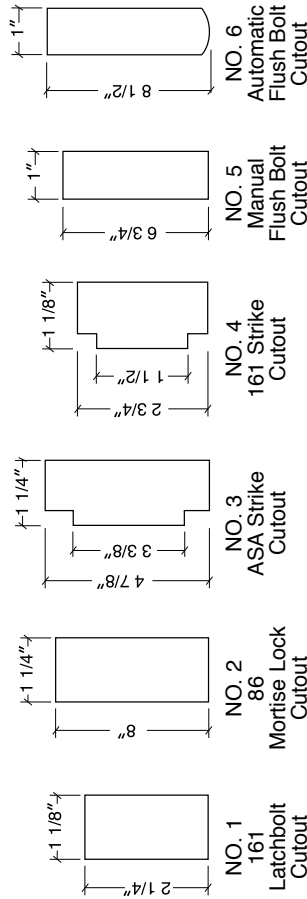

Handing Information

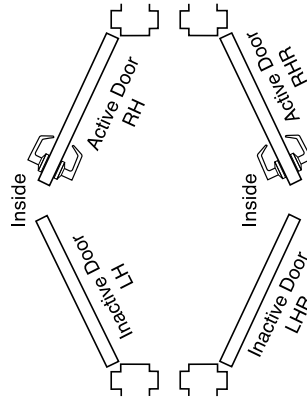

Line #	Qty.	Model #	Mounting Screws	Hand	Y Door Thickness	A Total Length	Length from bottom of edge guard to the centerline of cutout		
							First cut out No.	Second cut out No.	Third cut Out No.
1									
2									
3									
4									
5									

Customer Signature: \_\_\_\_\_ Date: \_\_\_\_\_ B-324 3/07

# Electronic Power Transfer Form

Hinges & Door Accessories

Customer Name: \_\_\_\_\_

Customer Name: \_\_\_\_\_

Phone Number: \_\_\_\_\_

Customer P.O.#: \_\_\_\_\_

Date: \_\_\_\_\_

Please Choose: \_\_\_\_\_ Aluminum Geared Hinge  
 \_\_\_\_\_ Steel or Stainless Steel Continuous Pinned Hinge

Hinge Type: \_\_\_\_\_

Hinge Length: \_\_\_\_\_

# of RIGHT HAND Hinges: \_\_\_\_\_

# of LEFT HAND Hinges: \_\_\_\_\_

Prep location from TOP of the hinge to the centerline of the prep: \_\_\_\_\_

Manufacturer:	Manufacturer EPT Number:	BEST Number:	Quantity:
ABH	PT105	PT105	
	PT180	PT180	
Abloy	ES280	ES280	
	EA281	EA281	
Adam-Rite	4612-1	46121	
	4612-2	46122	
Precision	EPT-5	EPT5	
	9512	9512	
	9513	9513	
Securitron	EPT	EPT	
	EPTL	EPTL	
Von Duprin	EPT2	EPT2	
	EPT10	EPT10	
	PNT1	PNT1	
Other:	Please provide drawing for cutout prep.		

Customer Signature: \_\_\_\_\_



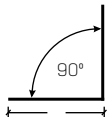
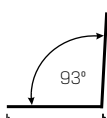
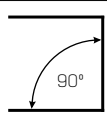
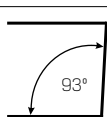
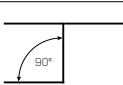
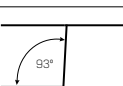

# Edge Guards

Model	Size	Finish	BHMA	EDP #	Stock Item	List Price	UOM	Order Multiple	Box Qty	Carton Qty	MPG
 <b>EG1</b> Half Wrap Square	3' (36")					13754	Ea.	1Ea	1Ea	1Ea	
	4' (48")					16453	Ea.	1Ea	1Ea	1Ea	
	5' (60")					19152	Ea.	1Ea	1Ea	1Ea	
	6' (72")					21851	Ea.	1Ea	1Ea	1Ea	
	7' 2" (86")					24551	Ea.	1Ea	1Ea	1Ea	
	8' (96")					27250	Ea.	1Ea	1Ea	1Ea	
	9' (108")					29949	Ea.	1Ea	1Ea	1Ea	
 <b>EG1B</b> Half Wrap Beveled	3' (36")					13754	Ea.	1Ea	1Ea	1Ea	
	4' (48")					16453	Ea.	1Ea	1Ea	1Ea	
	5' (60")					19152	Ea.	1Ea	1Ea	1Ea	
	6' (72")					21851	Ea.	1Ea	1Ea	1Ea	
	7' 2" (86")					24551	Ea.	1Ea	1Ea	1Ea	
	8' (96")					27250	Ea.	1Ea	1Ea	1Ea	
	9' (108")					29949	Ea.	1Ea	1Ea	1Ea	
 <b>EG2</b> Full Wrap Square	3' (36")					21851	Ea.	1Ea	1Ea	1Ea	
	4' (48")					24551	Ea.	1Ea	1Ea	1Ea	
	5' (60")					27250	Ea.	1Ea	1Ea	1Ea	
	6' (72")					29949	Ea.	1Ea	1Ea	1Ea	
	7' 2" (86")					32649	Ea.	1Ea	1Ea	1Ea	
	8' (96")					35348	Ea.	1Ea	1Ea	1Ea	
	9' (108")					38047	Ea.	1Ea	1Ea	1Ea	
 <b>EG2B</b> Full Wrap Beveled	3' (36")					21851	Ea.	1Ea	1Ea	1Ea	
	4' (48")					24551	Ea.	1Ea	1Ea	1Ea	
	5' (60")					27250	Ea.	1Ea	1Ea	1Ea	
	6' (72")					29949	Ea.	1Ea	1Ea	1Ea	
	7' 2" (86")					32649	Ea.	1Ea	1Ea	1Ea	
	8' (96")					35348	Ea.	1Ea	1Ea	1Ea	
	9' (108")					38047	Ea.	1Ea	1Ea	1Ea	
 <b>EG3</b> Full Wrap Square with Astragal	3' (36")					29949	Ea.	1Ea	1Ea	1Ea	
	4' (48")					32649	Ea.	1Ea	1Ea	1Ea	
	5' (60")					35348	Ea.	1Ea	1Ea	1Ea	
	6' (72")					38047	Ea.	1Ea	1Ea	1Ea	
	7' 2" (86")					40747	Ea.	1Ea	1Ea	1Ea	
	8' (96")					43446	Ea.	1Ea	1Ea	1Ea	
	9' (108")					46145	Ea.	1Ea	1Ea	1Ea	
 <b>EG3B</b> Full Wrap Beveled with Astragal	3' (36")					29949	Ea.	1Ea	1Ea	1Ea	
	4' (48")					32649	Ea.	1Ea	1Ea	1Ea	
	5' (60")					35348	Ea.	1Ea	1Ea	1Ea	
	6' (72")					38047	Ea.	1Ea	1Ea	1Ea	
	7' 2" (86")					40747	Ea.	1Ea	1Ea	1Ea	
	8' (96")					43446	Ea.	1Ea	1Ea	1Ea	
	9' (108")					46145	Ea.	1Ea	1Ea	1Ea	
10' (120")					48845	Ea.	1Ea	1Ea	1Ea		

## Edge Guard Hinge Extras

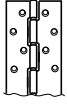
Model	Size	Finish	BHMA	EDP #	Stock Item	List Price	UOM	Order Multiple	Box Qty	Carton Qty	MPG
Edge Guard Cut Out	3' (36")					44.83					
Custom Hole Pattern	4' (48")					72.31		Ea. Hinge			
Set-Up Charge For Painting Less Than 20 Hinges	5' (60")					319.55		Per Order			

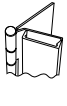
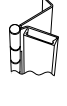
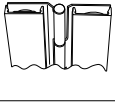
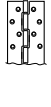
Edge Guards are available on 641UL and 651UL. Please fill out Edge Guard Form on prior page and submit with order

	Model	Size	Finish	BHMA	EDP #	Stock Item	List Price	UOM	Order Multiple	Box Qty	Carton Qty	MPG
	<b>641 UL</b> Steel Full Mortise Continuous Hinge	6'8"	P	600	71161060	✓	390.21	Ea.	1Ea.	1Pk.	1Pk.	E9
		7'0"	P	600	71161062	✓	390.21	Ea.	1Ea.	1Pk.	1Pk.	E9
		7'2"	P	600	71161063		412.68	Ea.	1Pk.	1Pk.	1Pk.	E9
		8'0"	P	600	71161064		575.56	Ea.	1Pk.	1Pk.	1Pk.	E9
		10'0"	P	600	71161065		690.70	Ea.	1Pk.	1Pk.	1Pk.	E9
	<b>643 UL</b> Steel Full Mortise w/Half Wrap Edge Guard Continuous Hinge	6'8"	P	600	71161066		418.30	Ea.	1Pk.	1Pk.	1Pk.	E9
		7'0"	P	600	71161067		418.30	Ea.	1Pk.	1Pk.	1Pk.	E9
		7'2"	P	600	71161068		440.76	Ea.	1Pk.	1Pk.	1Pk.	E9
		8'0"	P	600	71161069		485.70	Ea.	1Pk.	1Pk.	1Pk.	E9
		10'0"	P	600	71161070		707.55	Ea.	1Pk.	1Pk.	1Pk.	E9
	<b>644 UL</b> Steel Half Mortise Continuous Hinge	6'8"	P	600	71161072		463.23	Ea.	1Pk.	1Pk.	1Pk.	E9
		7'0"	P	600	71161073		463.23	Ea.	1Pk.	1Pk.	1Pk.	E9
		7'2"	P	600	71161074		463.23	Ea.	1Pk.	1Pk.	1Pk.	E9
		8'0"	P	600	71161075		463.23	Ea.	1Pk.	1Pk.	1Pk.	E9
		10'0"	P	600	71161076		763.72	Ea.	1Pk.	1Pk.	1Pk.	E9
	<b>645 UL</b> Steel Half Mortise w/Half Wrap Edge Guard Continuous Hinge	6'8"	P	600	71161077		510.97	Ea.	1Pk.	1Pk.	1Pk.	E9
		7'0"	P	600	71161078		510.97	Ea.	1Pk.	1Pk.	1Pk.	E9
		7'2"	P	600	71161079		533.44	Ea.	1Pk.	1Pk.	1Pk.	E9
		8'0"	P	600	71161080		606.45	Ea.	1Pk.	1Pk.	1Pk.	E9
		10'0"	P	600	71161082		918.17	Ea.	1Pk.	1Pk.	1Pk.	E9
	<b>646 UL</b> Steel Swing-Clear Continuous Hinge	6'8"	P	600	71161083		873.24	Ea.	1Pk.	1Pk.	1Pk.	E9
		7'0"	P	600	71161084		873.24	Ea.	1Pk.	1Pk.	1Pk.	E9
		7'2"	P	600	71161085		895.70	Ea.	1Pk.	1Pk.	1Pk.	E9
		8'0"	P	600	71161086		940.64	Ea.	1Pk.	1Pk.	1Pk.	E9
		10'0"	P	600	71161087		985.57	Ea.	1Pk.	1Pk.	1Pk.	E9
	<b>647 UL</b> Steel Full Surface Continuous Hinge	6'8"	P	600	71161088		569.94	Ea.	1Pk.	1Pk.	1Pk.	E9
		7'0"	P	600	71161089		569.94	Ea.	1Pk.	1Pk.	1Pk.	E9
		7'2"	P	600	71161090		569.94	Ea.	1Pk.	1Pk.	1Pk.	E9
		8'0"	P	600	71161091		687.89	Ea.	1Pk.	1Pk.	1Pk.	E9
		10'0"	P	600	71161092		890.09	Ea.	1Pk.	1Pk.	1Pk.	E9
	<b>651 UL</b> Stainless Steel Full Mortise Continuous Hinge	6'8"	32D	630	71161093	✓	710.36	Ea.	1Pk.	1Pk.	1Pk.	E9
		7'0"	32D	630	71161094	✓	710.36	Ea.	1Pk.	1Pk.	1Pk.	E9
		7'2"	32D	630	71161095	✓	732.82	Ea.	1Pk.	1Pk.	1Pk.	E9
		8'0"	32D	630	71161096		923.79	Ea.	1Pk.	1Pk.	1Pk.	E9
		10'0"	32D	630	71161097		985.57	Ea.	1Pk.	1Pk.	1Pk.	E9
	<b>651 HD UL</b> Heavy Duty Stainless Steel Full Mortise Continuous Hinge	6'8"	32D	630	71100438		1,170.91	Ea.	1Pk.	1Pk.	1Pk.	E9
		7'0"	32D	630	71100446		1,170.91	Ea.	1Pk.	1Pk.	1Pk.	E9
		7'2"	32D	630	71100453		1,238.31	Ea.	1Pk.	1Pk.	1Pk.	E9
		8'0"	32D	630	71100461		1,350.64	Ea.	1Pk.	1Pk.	1Pk.	E9
		10'0"	32D	630	71100479		1,710.13	Ea.	1Pk.	1Pk.	1Pk.	E9
	<b>651 UL-EPT2</b> FM Hinge 7 FT 32D STS with Pre-Configured EPT 2	7'0"	32D	630	71161137		784.83	Ea.	1Pk.	1Pk.	1Pk.	E9
	<b>651 UL-EPT5LH</b> FM Hinge 7 FT 32D STS with Pre-Configured EPT 5 LH	7'0"	32D	630	71161138		784.83	Ea.	1Pk.	1Pk.	1Pk.	E9
	<b>651 UL-EPT5RH</b> UL FM Hinge 7 FT 32D STS with Pre-Configured EPT 5 RH	7'0"	32D	630	71161139		784.83	Ea.	1Pk.	1Pk.	1Pk.	E9

# Steel and Stainless Steel Continuous Hinges (cont.)

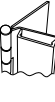
	Model	Size	Finish	BHMA	EDP #	Stock Item	List Price	UOM	Order Multiple	Box Qty	Carton Qty	MPG
	<b>652 UL</b>	6'8"	32D	630	71161098		915.36	Ea.	1Pk.	1Pk.	1Pk.	E9
	Stainless Steel Full Mortise Continuous Hinge w/Full Wrap Edge Guard	7'0"	32D	630	71161099	✓	915.36	Ea.	1Pk.	1Pk.	1Pk.	E9
		7'2"	32D	630	71161100		940.64	Ea.	1Pk.	1Pk.	1Pk.	E9
		8'0"	32D	630	71161107		1,072.63	Ea.	1Pk.	1Pk.	1Pk.	E9
		10'0"	32D	630	71161108		1,283.25	Ea.	1Pk.	1Pk.	1Pk.	E9
	<b>652 HD UL</b>	6'8"	32D	630	71100487		1,527.59	Ea.	1Pk.	1Pk.	1Pk.	E9
	Heavy Duty Stainless Steel Full Mortise Continuous Hinge	7'0"	32D	630	71100495		1,527.59	Ea.	1Pk.	1Pk.	1Pk.	E9
		7'2"	32D	630	71100503		1,614.65	Ea.	1Pk.	1Pk.	1Pk.	E9
		8'0"	32D	630	71100511		1,707.32	Ea.	1Pk.	1Pk.	1Pk.	E9
		10'0"	32D	630	71100529		2,103.26	Ea.	1Pk.	1Pk.	1Pk.	E9
	<b>652 UL-EPT2LH</b>	7'0"	32D	630	71161140		976.91	Ea.	1Pk.	1Pk.	1Pk.	E9
	FM Hinge 7 FT 32D STS with Pre-Configured EPT 2 LH											
	<b>652 UL-EPT2RH</b>	7'0"	32D	630	71161141		976.91	Ea.	1Pk.	1Pk.	1Pk.	E9
	FM Hinge 7 FT 32D STS with Pre-ConfigureD EPT 2 RH											
	<b>652 UL-EPT5LH</b>	7'0"	32D	630	71161142		976.91	Ea.	1Pk.	1Pk.	1Pk.	E9
	FM Hinge 7 FT 32D STS with Pre-Configured EPT 5 LH											
	<b>652 UL-EPT5RH</b>	7'0"	32D	630	71161143		976.91	Ea.	1Pk.	1Pk.	1Pk.	E9
	FM Hinge 7 FT 32D STS with Pre-Configured EPT 5 RH											
	<b>653 UL</b>	6'8"	32D	630	71161109		859.20	Ea.	1Pk.	1Pk.	1Pk.	E9
	Stainless Steel Full Mortise Continuous Hinge w/Half Wrap Edge Guard	7'0"	32D	630	71161110	✓	859.20	Ea.	1Pk.	1Pk.	1Pk.	E9
		7'2"	32D	630	71161111		881.66	Ea.	1Pk.	1Pk.	1Pk.	E9
		8'0"	32D	630	71161112		904.13	Ea.	1Pk.	1Pk.	1Pk.	E9
		10'0"	32D	630	71161113		1,081.05	Ea.	1Pk.	1Pk.	1Pk.	E9
	<b>653 HD UL</b>	6'8"	32D	630	71100537		1,277.63	Ea.	1Pk.	1Pk.	1Pk.	E9
	Heavy Duty Stainless Steel Full Mortise Continuous Hinge w/ Half Wrap Edge Guard	7'0"	32D	630	71100545		1,277.63	Ea.	1Pk.	1Pk.	1Pk.	E9
		7'2"	32D	630	71100552		1,342.22	Ea.	1Pk.	1Pk.	1Pk.	E9
		8'0"	32D	630	71100560		1,460.19	Ea.	1Pk.	1Pk.	1Pk.	E9
		10'0"	32D	630	71100578		1,825.27	Ea.	1Pk.	1Pk.	1Pk.	E9
	<b>654 UL</b>	6'8"	32D	630	71161114		738.44	Ea.	1Pk.	1Pk.	1Pk.	E9
	Stainless Steel Half Mortise Continuous Hinge	7'0"	32D	630	71161115		738.44	Ea.	1Pk.	1Pk.	1Pk.	E9
		7'2"	32D	630	71161116		738.44	Ea.	1Pk.	1Pk.	1Pk.	E9
		8'0"	32D	630	71161117		909.75	Ea.	1Pk.	1Pk.	1Pk.	E9
		10'0"	32D	630	71161118		1,120.37	Ea.	1Pk.	1Pk.	1Pk.	E9
	<b>655 UL</b>	6'8"	32D	630	71161119		755.29	Ea.	1Pk.	1Pk.	1Pk.	E9
	Stainless Steel Half Mortise Continuous Hinge w/Half Wrap Edge Guard	7'0"	32D	630	71161120		755.29	Ea.	1Pk.	1Pk.	1Pk.	E9
		7'2"	32D	630	71161121		777.76	Ea.	1Pk.	1Pk.	1Pk.	E9
		8'0"	32D	630	71161122		887.28	Ea.	1Pk.	1Pk.	1Pk.	E9
		10'0"	32D	630	71161123		1,092.28	Ea.	1Pk.	1Pk.	1Pk.	E9
	<b>656 UL</b>	6'8"	32D	630	71161124		833.92	Ea.	1Pk.	1Pk.	1Pk.	E9
	Stainless Steel Swing-Clear Continuous Hinge	7'0"	32D	630	71161125		833.92	Ea.	1Pk.	1Pk.	1Pk.	E9
		7'2"	32D	630	71161126		833.92	Ea.	1Pk.	1Pk.	1Pk.	E9
		8'0"	32D	630	71161127		954.68	Ea.	1Pk.	1Pk.	1Pk.	E9
		10'0"	32D	630	71161128		1,170.91	Ea.	1Pk.	1Pk.	1Pk.	E9
<b>657 UL</b>	Stainless Steel Full Surface Continuous Hinge	6'8"	32D	630	71161129		800.22	Ea.	1Pk.	1Pk.	1Pk.	E9
		7'0"	32D	630	71161130		800.22	Ea.	1Pk.	1Pk.	1Pk.	E9
		7'2"	32D	630	71161131		814.26	Ea.	1Pk.	1Pk.	1Pk.	E9
		8'0"	32D	630	71161132		1,120.37	Ea.	1Pk.	1Pk.	1Pk.	E9
		10'0"	32D	630	71161133		1,187.76	Ea.	1Pk.	1Pk.	1Pk.	E9

# Steel and Stainless Steel Continuous Hinge Extras

## Hinges & Door Accessories

Model	Size	Finish	BHMA	EDP #	Stock Item	List Price	UOM	Order Multiple	Box Qty	Carton Qty	MPG
Painted (Powder Coat) Finish					MTO	14157		Ea. Hinge			
Polished Stainless Steel Finish (US32) - 650 Series Only		32	629		MTO	106.17		Ea. Hinge			
Phillips Head #10 x 1/2" Self Drilling Screws					MTO	78.89		100 Ea./Box			
Steel Thru Bolts 1/4" - 20 x 1-3/4" w/1/4" - 20 x 1" Phillips Head Machine Screw					161146	70.72		16 Ea./Pk.			
Cutting Charges					MTO	95.27		Ea. Hinge			
Hospital Tips					MTO	78.89		Ea. Hinge			
Dutch Door Prep (specify cut position from bottom of hinge)					MTO	57.09		Ea. Hinge			
Raised Barrel (specify hand)					MTO	78.89		Ea. Hinge			
Shims	83"					17160					
Narrow (sheared) leaves for 1-3/8" thick doors					MTO	103.45					
CS (Concealed Switch)						360.20					
EPT (Electric Power Transfer) Prep					MTO	117.04					
CE600 Concealed Electric Current Transfer-Order with 641, or, 643, or 651, or 653. Specify hand. Add to hinge price.		P	600	162101		484.92	Ea.	1Ea.	1Pk.	1Ea.	E9
Adjustable Door Bottom						46.57		1Ea.			
Welded Tip					MTO	26.45		Ea. Hinge			

Hospital Tip option available on the following hinges, please indicate at time of order: 641UL, 641HDUL, 643UL, 643HDUL, 644UL, 644HDUL, 645UL, 645HDUL, 646UL, 646HDUL, 647UL, 651UL, 651HDUL, 652UL, 652HDUL, 653UL, 653HDUL, 654UL, 654HDUL, 655UL, 655HDUL, 656UL, 656HDUL, and 657UL. CS option available on the following hinges, please indicate handing at time of order: 641UL, 641HDUL, 643UL, 643HDUL, 651UL, 651HDUL, 653UL, and 653HDUL

All prices are for items furnished with screws (as specified in catalog) unless otherwise stated in price list.  
 \* To price other finishes on architectural items – See pricing extras.

\*\* For conversion pins and decorative tips – See Miscellaneous Architectural Parts.  
 (X) Item must be ordered in these increments.



# Aluminum Based Continuous Hinges

# Hinges & Door Accessories

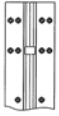
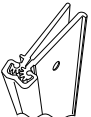
Model	Size	Finish	BHMA	EDP #	Stock Item	List Price	UOM	Order Multiple	Box Qty	Carton Qty	MPG	
 <b>661 HD UL</b> Aluminum Full Mortise, 13/4" Door Heavy Duty Hinge Continuous Hinge	79"	AL		71477808	✓	97.04	Ea.	1Ea.	1Ea.	1Ea.	N3	
		DB		71477809	✓	124.62	Ea.	1Ea.	1Ea.	1Ea.	N3	
		BK		71950325		158.00	Ea.	1Ea.	1Ea.	1Ea.	N3	
	83"	AL		71477810	✓	173.47	Ea.	1Ea.	1Ea.	1Ea.	1Ea.	N3
		DB		71477811	✓	222.78	Ea.	1Ea.	1Ea.	1Ea.	1Ea.	N3
		BK		71950326	✓	158.00	Ea.	1Ea.	1Ea.	1Ea.	1Ea.	N3
	85"	AL		71950755	✓	173.47	Ea.	1Ea.	1Ea.	1Ea.	1Ea.	N3
		DB		71950756	✓	222.78	Ea.	1Ea.	1Ea.	1Ea.	1Ea.	N3
		BK		71950669	✓	158.00	Ea.	1Ea.	1Ea.	1Ea.	1Ea.	N3
	95"	AL		71477812	✓	207.00	Ea.	1Ea.	1Ea.	1Ea.	1Ea.	N3
		DB		71477813	✓	274.06	Ea.	1Ea.	1Ea.	1Ea.	1Ea.	N3
		BK		71950327	✓	206.00	Ea.	1Ea.	1Ea.	1Ea.	1Ea.	N3
	120"	AL		71477814	✓	333.23	Ea.	1Ea.	1Ea.	1Ea.	1Ea.	N3
		DB		71477815	✓	439.74	Ea.	1Ea.	1Ea.	1Ea.	1Ea.	N3
		BK		71950328		299.00	Ea.	1Ea.	1Ea.	1Ea.	1Ea.	N3
<b>661 HD UL LL</b> Aluminum Full Mortise 13/4" Door Heavy Duty Hinge with Lead Lined Option	79"	AL		71950329		135.00	Ea.	1Ea.	1Ea.	1Ea.	N3	
		DB		71950330		174.00	Ea.	1Ea.	1Ea.	1Ea.	1Ea.	N3
		BK		71950331		200.00	Ea.	1Ea.	1Ea.	1Ea.	1Ea.	N3
	83"	AL		71950335		135.00	Ea.	1Ea.	1Ea.	1Ea.	1Ea.	N3
		DB		71950336		174.00	Ea.	1Ea.	1Ea.	1Ea.	1Ea.	N3
		BK		71950337		200.00	Ea.	1Ea.	1Ea.	1Ea.	1Ea.	N3
	85"	AL		71950670		135.00	Ea.	1Ea.	1Ea.	1Ea.	1Ea.	N3
		DB		71950671		174.00	Ea.	1Ea.	1Ea.	1Ea.	1Ea.	N3
		BK		71950672		200.00	Ea.	1Ea.	1Ea.	1Ea.	1Ea.	N3
	95"	AL		71950341		177.00	Ea.	1Ea.	1Ea.	1Ea.	1Ea.	N3
		DB		71950342		225.00	Ea.	1Ea.	1Ea.	1Ea.	1Ea.	N3
		BK		71950343		260.00	Ea.	1Ea.	1Ea.	1Ea.	1Ea.	N3
	120"	AL		71950347		258.00	Ea.	1Ea.	1Ea.	1Ea.	1Ea.	N3
		DB		71950348		330.00	Ea.	1Ea.	1Ea.	1Ea.	1Ea.	N3
		BK		71950349		379.00	Ea.	1Ea.	1Ea.	1Ea.	1Ea.	N3
<b>661 HD UL WT</b> Aluminum Full Mortise 13/4" Door Heavy Duty Hinge Wide Throw	79"	AL		71950332		270.00	Ea.	1Ea.	1Ea.	1Ea.	N3	
		DB		71950333		345.00	Ea.	1Ea.	1Ea.	1Ea.	1Ea.	N3
		BK		71950334		396.00	Ea.	1Ea.	1Ea.	1Ea.	1Ea.	N3
	83"	AL		71950338		270.00	Ea.	1Ea.	1Ea.	1Ea.	1Ea.	N3
		DB		71950339		345.00	Ea.	1Ea.	1Ea.	1Ea.	1Ea.	N3
		BK		71950340		396.00	Ea.	1Ea.	1Ea.	1Ea.	1Ea.	N3
	85"	AL		71950673		270.00	Ea.	1Ea.	1Ea.	1Ea.	1Ea.	N3
		DB		71950674		345.00	Ea.	1Ea.	1Ea.	1Ea.	1Ea.	N3
		BK		71950675		396.00	Ea.	1Ea.	1Ea.	1Ea.	1Ea.	N3
	95"	AL		71950344		351.00	Ea.	1Ea.	1Ea.	1Ea.	1Ea.	N3
		DB		71950345		449.00	Ea.	1Ea.	1Ea.	1Ea.	1Ea.	N3
		BK		71950346		516.00	Ea.	1Ea.	1Ea.	1Ea.	1Ea.	N3
	120"	AL		71950350		512.00	Ea.	1Ea.	1Ea.	1Ea.	1Ea.	N3
		DB		71950351		655.00	Ea.	1Ea.	1Ea.	1Ea.	1Ea.	N3
		BK		71950352		753.00	Ea.	1Ea.	1Ea.	1Ea.	1Ea.	N3
 <b>662 HD UL</b> Aluminum Full Mortise, 3/32" Inset Heavy Duty Hinge Continuous Hinge	79"	AL		71477800	✓	175.44	Ea.	1Ea.	1Ea.	1Ea.	N3	
		DB		71477801	✓	228.69	Ea.	1Ea.	1Ea.	1Ea.	1Ea.	N3
		BK		71950353		158.00	Ea.	1Ea.	1Ea.	1Ea.	1Ea.	N3
	83"	AL		71477802	✓	175.44	Ea.	1Ea.	1Ea.	1Ea.	1Ea.	N3
		DB		71477803	✓	228.69	Ea.	1Ea.	1Ea.	1Ea.	1Ea.	N3
		BK		71950354		158.00	Ea.	1Ea.	1Ea.	1Ea.	1Ea.	N3
	85"	AL		71950772		99.00	Ea.	1Ea.	1Ea.	1Ea.	1Ea.	N3
		DB		71950773		99.00	Ea.	1Ea.	1Ea.	1Ea.	1Ea.	N3
		BK		71950676		158.00	Ea.	1Ea.	1Ea.	1Ea.	1Ea.	N3
	95"	AL		71477804	✓	212.92	Ea.	1Ea.	1Ea.	1Ea.	1Ea.	N3
		DB		71477805	✓	279.98	Ea.	1Ea.	1Ea.	1Ea.	1Ea.	N3
		BK		71950355		206.00	Ea.	1Ea.	1Ea.	1Ea.	1Ea.	N3
	120"	AL		71477806	✓	347.04	Ea.	1Ea.	1Ea.	1Ea.	1Ea.	N3
		DB		71477807	✓	451.57	Ea.	1Ea.	1Ea.	1Ea.	1Ea.	N3
		BK		71950356		299.00	Ea.	1Ea.	1Ea.	1Ea.	1Ea.	N3

NOTE: Custom Aluminum Geared Hinges (models 661 - 681) are subject to an additional \$50.00 fee per order. Customization includes any feature listed on page

# Aluminum Based Continuous Hinges (cont.)

# Hinges & Door Accessories

Model	Size	Finish	BHMA	EDP #	Stock Item	List Price	UOM	Order Multiple	Box Qty	Carton Qty	MPG	
<b>662 HD UL LL</b> Aluminum Heavy Duty Full Mortise 3/32" Inset Hinge with Lead Lined Option	79"	AL		711950357		135.00	Ea.	1Ea.	1Ea.	1Ea.	N3	
		DB		711950358		135.00	Ea.	1Ea.	1Ea.	1Ea.	N3	
		BK		711950359		177.00	Ea.	1Ea.	1Ea.	1Ea.	N3	
	83"	AL		711950360		258.00	Ea.	1Ea.	1Ea.	1Ea.	1Ea.	N3
		DB		711950361		174.00	Ea.	1Ea.	1Ea.	1Ea.	1Ea.	N3
		BK		711950362		177.00	Ea.	1Ea.	1Ea.	1Ea.	1Ea.	N3
	85"	AL		711950677		258.00	Ea.	1Ea.	1Ea.	1Ea.	1Ea.	N3
		DB		711950678		174.00	Ea.	1Ea.	1Ea.	1Ea.	1Ea.	N3
		BK		711950679		177.00	Ea.	1Ea.	1Ea.	1Ea.	1Ea.	N3
	95"	AL		711950363		225.00	Ea.	1Ea.	1Ea.	1Ea.	1Ea.	N3
		DB		711950364		330.00	Ea.	1Ea.	1Ea.	1Ea.	1Ea.	N3
		BK		711950365		200.00	Ea.	1Ea.	1Ea.	1Ea.	1Ea.	N3
	120"	AL		711950366		218.00	Ea.	1Ea.	1Ea.	1Ea.	1Ea.	N3
		DB		711950367		260.00	Ea.	1Ea.	1Ea.	1Ea.	1Ea.	N3
		BK		711950368	✓	379.00	Ea.	1Ea.	1Ea.	1Ea.	1Ea.	N3
 <b>663 HD UL</b> Aluminum Half Surface, 1-3/4" Doors Heavy Duty Hinge Continuous Hinge	79"	AL		711477792	✓	268.14	Ea.	1Ea.	1Ea.	1Ea.	N3	
		DB		711477793	✓	327.31	Ea.	1Ea.	1Ea.	1Ea.	1Ea.	N3
		BK		711950369		247.00	Ea.	1Ea.	1Ea.	1Ea.	1Ea.	N3
	83"	AL		711477794	✓	268.14	Ea.	1Ea.	1Ea.	1Ea.	1Ea.	N3
		DB		711477795	✓	327.31	Ea.	1Ea.	1Ea.	1Ea.	1Ea.	N3
		BK		711950370		247.00	Ea.	1Ea.	1Ea.	1Ea.	1Ea.	N3
	85"	AL		711950757		150.00	Ea.	1Ea.	1Ea.	1Ea.	1Ea.	N3
		DB		711950758		184.00	Ea.	1Ea.	1Ea.	1Ea.	1Ea.	N3
		BK		711950680		247.00	Ea.	1Ea.	1Ea.	1Ea.	1Ea.	N3
	95"	AL		711477796	✓	329.28	Ea.	1Ea.	1Ea.	1Ea.	1Ea.	N3
		DB		711477797		327.31	Ea.	1Ea.	1Ea.	1Ea.	1Ea.	N3
		BK		711950371		321.00	Ea.	1Ea.	1Ea.	1Ea.	1Ea.	N3
	120"	AL		711477798		506.80	Ea.	1Ea.	1Ea.	1Ea.	1Ea.	N3
		DB		711477799	✓	652.75	Ea.	1Ea.	1Ea.	1Ea.	1Ea.	N3
		BK		711950372		468.00	Ea.	1Ea.	1Ea.	1Ea.	1Ea.	N3
 <b>664 HD UL</b> Aluminum Full Surface Heavy Duty Hinge Continuous Hinge	79"	AL		711477816	✓	287.86	Ea.	1Ea.	1Ea.	1Ea.	N3	
		DB		711477817	✓	402.26	Ea.	1Ea.	1Ea.	1Ea.	1Ea.	N3
		BK		711950373		244.00	Ea.	1Ea.	1Ea.	1Ea.	1Ea.	N3
	83"	AL		711477818	✓	287.86	Ea.	1Ea.	1Ea.	1Ea.	1Ea.	N3
		DB		711477819	✓	402.26	Ea.	1Ea.	1Ea.	1Ea.	1Ea.	N3
		BK		711950374		244.00	Ea.	1Ea.	1Ea.	1Ea.	1Ea.	N3
	85"	AL		711950774		162.00	Ea.	1Ea.	1Ea.	1Ea.	1Ea.	N3
		DB		711950775		226.00	Ea.	1Ea.	1Ea.	1Ea.	1Ea.	N3
		BK		711950681		244.00	Ea.	1Ea.	1Ea.	1Ea.	1Ea.	N3
	95"	AL		711477820	✓	360.84	Ea.	1Ea.	1Ea.	1Ea.	1Ea.	N3
		DB		711477821	✓	496.93	Ea.	1Ea.	1Ea.	1Ea.	1Ea.	N3
		BK		711950375		317.00	Ea.	1Ea.	1Ea.	1Ea.	1Ea.	N3
	120"	AL		711477822	✓	538.35	Ea.	1Ea.	1Ea.	1Ea.	1Ea.	N3
		DB		711477823	✓	739.53	Ea.	1Ea.	1Ea.	1Ea.	1Ea.	N3
		BK		711950376		463.00	Ea.	1Ea.	1Ea.	1Ea.	1Ea.	N3
 <b>665 HD UL</b> Aluminum Full Surface Heavy Duty Hinge Continuous Hinge	79"	AL		711477824	✓	260.25	Ea.	1Ea.	1Ea.	1Ea.	N3	
		DB		711477825	✓	317.45	Ea.	1Ea.	1Ea.	1Ea.	1Ea.	N3
		BK		711950377		244.00	Ea.	1Ea.	1Ea.	1Ea.	1Ea.	N3
	83"	AL		711477826	✓	260.25	Ea.	1Ea.	1Ea.	1Ea.	1Ea.	N3
		DB		711477827	✓	317.45	Ea.	1Ea.	1Ea.	1Ea.	1Ea.	N3
		BK		711950378		244.00	Ea.	1Ea.	1Ea.	1Ea.	1Ea.	N3
	85"	AL		711950759		175.00	Ea.	1Ea.	1Ea.	1Ea.	1Ea.	N3
		DB		711950760		181.13	Ea.	1Ea.	1Ea.	1Ea.	1Ea.	N3
		BK		711950682		244.00	Ea.	1Ea.	1Ea.	1Ea.	1Ea.	N3
	95"	AL		711477828	✓	307.59	Ea.	1Ea.	1Ea.	1Ea.	1Ea.	N3
		DB		711477829	✓	376.62	Ea.	1Ea.	1Ea.	1Ea.	1Ea.	N3
		BK		711950379		317.00	Ea.	1Ea.	1Ea.	1Ea.	1Ea.	N3
	120"	AL		711477830	✓	508.77	Ea.	1Ea.	1Ea.	1Ea.	1Ea.	N3
		DB		711477831		569.91	Ea.	1Ea.	1Ea.	1Ea.	1Ea.	N3
		BK		711950380		463.00	Ea.	1Ea.	1Ea.	1Ea.	1Ea.	N3

NOTE: Custom Aluminum Geared Hinges (models 661 - 681) are subject to an additional \$50.00 fee per order. Customization includes any feature listed on page

# Aluminum Based Continuous Hinges (cont.)

# Hinges & Door Accessories

Model	Size	Finish	BHMA	EDP #	Stock Item	List Price	UOM	Order Multiple	Box Qty	Carton Qty	MPG
<b>667 HD UL</b> Aluminum Heavy Duty Full Mortise for 1/8" inset doors	79"	AL		711950381		108.00	Ea.	1Ea.	1Ea.	1Ea.	N3
		DB		711950385		137.00	Ea.	1Ea.	1Ea.	1Ea.	N3
		BK		711950389		158.00	Ea.	1Ea.	1Ea.	1Ea.	N3
	83"	AL		711950382		108.00	Ea.	1Ea.	1Ea.	1Ea.	N3
		DB		711950386		137.00	Ea.	1Ea.	1Ea.	1Ea.	N3
		BK		711950390		158.00	Ea.	1Ea.	1Ea.	1Ea.	N3
	85"	AL		711950683		108.00	Ea.	1Ea.	1Ea.	1Ea.	N3
		DB		711950684		137.00	Ea.	1Ea.	1Ea.	1Ea.	N3
		BK		711950685		158.00	Ea.	1Ea.	1Ea.	1Ea.	N3
	95"	AL		711950383		140.00	Ea.	1Ea.	1Ea.	1Ea.	N3
		DB		711950387		179.00	Ea.	1Ea.	1Ea.	1Ea.	N3
		BK		711950391		206.00	Ea.	1Ea.	1Ea.	1Ea.	N3
	120"	AL		711950384		204.00	Ea.	1Ea.	1Ea.	1Ea.	N3
		DB		711950388		261.00	Ea.	1Ea.	1Ea.	1Ea.	N3
		BK		711950392		299.00	Ea.	1Ea.	1Ea.	1Ea.	N3
<b>667 HD UL LL</b> Aluminum Heavy Duty Full Mortise for 1/8" inset doors with Lead Lined option	79"	AL		711950393		135.00	Ea.	1Ea.	1Ea.	1Ea.	N3
		DB		711950397		174.00	Ea.	1Ea.	1Ea.	1Ea.	N3
		BK		711950401		200.00	Ea.	1Ea.	1Ea.	1Ea.	N3
	83"	AL		711950394		135.00	Ea.	1Ea.	1Ea.	1Ea.	N3
		DB		711950398		174.00	Ea.	1Ea.	1Ea.	1Ea.	N3
		BK		711950402		200.00	Ea.	1Ea.	1Ea.	1Ea.	N3
	85"	AL		711950686		135.00	Ea.	1Ea.	1Ea.	1Ea.	N3
		DB		711950687		174.00	Ea.	1Ea.	1Ea.	1Ea.	N3
		BK		711950688		200.00	Ea.	1Ea.	1Ea.	1Ea.	N3
	95"	AL		711950395		177.00	Ea.	1Ea.	1Ea.	1Ea.	N3
		DB		711950399		225.00	Ea.	1Ea.	1Ea.	1Ea.	N3
		BK		711950403		260.00	Ea.	1Ea.	1Ea.	1Ea.	N3
	120"	AL		711950396		258.00	Ea.	1Ea.	1Ea.	1Ea.	N3
		DB		711950400		330.00	Ea.	1Ea.	1Ea.	1Ea.	N3
		BK		711950404		379.00	Ea.	1Ea.	1Ea.	1Ea.	N3
<b>667 HD UL WT</b> Aluminum Heavy Duty Full Mortise for 1/8" inset doors - Wide Throw	79"	AL		711950405		270.00	Ea.	1Ea.	1Ea.	1Ea.	N3
		DB		711950409		345.00	Ea.	1Ea.	1Ea.	1Ea.	N3
		BK		711950413		396.00	Ea.	1Ea.	1Ea.	1Ea.	N3
	83"	AL		711950406		270.00	Ea.	1Ea.	1Ea.	1Ea.	N3
		DB		711950410		345.00	Ea.	1Ea.	1Ea.	1Ea.	N3
		BK		711950414		396.00	Ea.	1Ea.	1Ea.	1Ea.	N3
	85"	AL		711950689		270.00	Ea.	1Ea.	1Ea.	1Ea.	N3
		DB		711950690		345.00	Ea.	1Ea.	1Ea.	1Ea.	N3
		BK		711950691		396.00	Ea.	1Ea.	1Ea.	1Ea.	N3
	95"	AL		711950407		351.00	Ea.	1Ea.	1Ea.	1Ea.	N3
		DB		711950411		449.00	Ea.	1Ea.	1Ea.	1Ea.	N3
		BK		711950415		516.00	Ea.	1Ea.	1Ea.	1Ea.	N3
	120"	AL		711950408		512.00	Ea.	1Ea.	1Ea.	1Ea.	N3
		DB		711950412		655.00	Ea.	1Ea.	1Ea.	1Ea.	N3
		BK		711950416		753.00	Ea.	1Ea.	1Ea.	1Ea.	N3
<b>668 HD UL</b> Aluminum Heavy Duty Full Mortise for 1/16" inset doors	79"	AL		711950417		139.00	Ea.	1Ea.	1Ea.	1Ea.	N3
		DB		711950421		178.00	Ea.	1Ea.	1Ea.	1Ea.	N3
		BK		711950425		205.00	Ea.	1Ea.	1Ea.	1Ea.	N3
	83"	AL		711950418	✓	139.00	Ea.	1Ea.	1Ea.	1Ea.	N3
		DB		711950422		178.00	Ea.	1Ea.	1Ea.	1Ea.	N3
		BK		711950426		205.00	Ea.	1Ea.	1Ea.	1Ea.	N3
	85"	AL		711950692	✓	139.00	Ea.	1Ea.	1Ea.	1Ea.	N3
		DB		711950693		178.00	Ea.	1Ea.	1Ea.	1Ea.	N3
		BK		711950694		205.00	Ea.	1Ea.	1Ea.	1Ea.	N3
	95"	AL		711950419		180.00	Ea.	1Ea.	1Ea.	1Ea.	N3
		DB		711950423		231.00	Ea.	1Ea.	1Ea.	1Ea.	N3
		BK		711950427		265.00	Ea.	1Ea.	1Ea.	1Ea.	N3
	120"	AL		711950420		264.00	Ea.	1Ea.	1Ea.	1Ea.	N3
		DB		711950424		338.00	Ea.	1Ea.	1Ea.	1Ea.	N3
		BK		711950428		388.00	Ea.	1Ea.	1Ea.	1Ea.	N3

NOTE: Custom Aluminum Geared Hinges (models 661 - 681) are subject to an additional \$50.00 fee per order. Customization includes any feature listed on page

# Aluminum Based Continuous Hinges (cont.)

# Hinges & Door Accessories

Model	Size	Finish	BHMA	EDP #	Stock Item	List Price	UOM	Order Multiple	Box Qty	Carton Qty	MPG
<b>668 HD UL LL</b> Aluminum Heavy Duty Full Mortise for 1/16" inset doors with Lead Lined Option	79"	AL		711950429		168.00	Ea.	1Ea.	1Ea.	1Ea.	N3
		DB		711950433		215.00	Ea.	1Ea.	1Ea.	1Ea.	N3
		BK		711950437		247.00	Ea.	1Ea.	1Ea.	1Ea.	N3
	83"	AL		711950430		168.00	Ea.	1Ea.	1Ea.	1Ea.	N3
		DB		711950434		215.00	Ea.	1Ea.	1Ea.	1Ea.	N3
		BK		711950438		247.00	Ea.	1Ea.	1Ea.	1Ea.	N3
	85"	AL		711950695		218.00	Ea.	1Ea.	1Ea.	1Ea.	N3
		DB		711950696		279.00	Ea.	1Ea.	1Ea.	1Ea.	N3
		BK		711950697		247.00	Ea.	1Ea.	1Ea.	1Ea.	N3
	95"	AL		711950431		218.00	Ea.	1Ea.	1Ea.	1Ea.	N3
		DB		711950435		279.00	Ea.	1Ea.	1Ea.	1Ea.	N3
		BK		711950439		321.00	Ea.	1Ea.	1Ea.	1Ea.	N3
	120"	AL		711950432		320.00	Ea.	1Ea.	1Ea.	1Ea.	N3
		DB		711950436		409.00	Ea.	1Ea.	1Ea.	1Ea.	N3
		BK		711950440		470.00	Ea.	1Ea.	1Ea.	1Ea.	N3
<b>669 HD UL</b> Aluminum Heavy Duty Full Mortise for 3/32" inset doors	79"	AL		711950441		108.00	Ea.	1Ea.	1Ea.	1Ea.	N3
		DB		711950445		137.00	Ea.	1Ea.	1Ea.	1Ea.	N3
		BK		711950449		158.00	Ea.	1Ea.	1Ea.	1Ea.	N3
	83"	AL		711950442	✓	108.00	Ea.	1Ea.	1Ea.	1Ea.	N3
		DB		711950446		137.00	Ea.	1Ea.	1Ea.	1Ea.	N3
		BK		711950450		158.00	Ea.	1Ea.	1Ea.	1Ea.	N3
	85"	AL		711950698	✓	108.00	Ea.	1Ea.	1Ea.	1Ea.	N3
		DB		711950699		137.00	Ea.	1Ea.	1Ea.	1Ea.	N3
		BK		711950711		158.00	Ea.	1Ea.	1Ea.	1Ea.	N3
	95"	AL		711950443	✓	140.00	Ea.	1Ea.	1Ea.	1Ea.	N3
		DB		711950447		179.00	Ea.	1Ea.	1Ea.	1Ea.	N3
		BK		711950451		206.00	Ea.	1Ea.	1Ea.	1Ea.	N3
	120"	AL		711950444		204.00	Ea.	1Ea.	1Ea.	1Ea.	N3
		DB		711950448		261.00	Ea.	1Ea.	1Ea.	1Ea.	N3
		BK		711950452		299.00	Ea.	1Ea.	1Ea.	1Ea.	N3
<b>669 HD UL LL</b> Aluminum Heavy Duty Full Mortise for 3/32" inset doors with Lead Lined Option	79"	AL		711950453		135.00	Ea.	1Ea.	1Ea.	1Ea.	N3
		DB		711950457		174.00	Ea.	1Ea.	1Ea.	1Ea.	N3
		BK		711950461		200.00	Ea.	1Ea.	1Ea.	1Ea.	N3
	83"	AL		711950454		135.00	Ea.	1Ea.	1Ea.	1Ea.	N3
		DB		711950458		174.00	Ea.	1Ea.	1Ea.	1Ea.	N3
		BK		711950462		200.00	Ea.	1Ea.	1Ea.	1Ea.	N3
	85"	AL		711950701		135.00	Ea.	1Ea.	1Ea.	1Ea.	N3
		DB		711950702		174.00	Ea.	1Ea.	1Ea.	1Ea.	N3
		BK		711950703		200.00	Ea.	1Ea.	1Ea.	1Ea.	N3
	95"	AL		711950455		177.00	Ea.	1Ea.	1Ea.	1Ea.	N3
		DB		711950459		225.00	Ea.	1Ea.	1Ea.	1Ea.	N3
		BK		711950463		225.00	Ea.	1Ea.	1Ea.	1Ea.	N3
	120"	AL		711950456		258.00	Ea.	1Ea.	1Ea.	1Ea.	N3
		DB		711950460		330.00	Ea.	1Ea.	1Ea.	1Ea.	N3
		BK		711950464		330.00	Ea.	1Ea.	1Ea.	1Ea.	N3
<b>670 HD UL</b> Aluminum Heavy Duty Full Mortise Flush Mount (no door inset)	79"	AL		711950465		108.00	Ea.	1Ea.	1Ea.	1Ea.	N3
		DB		711950469		137.00	Ea.	1Ea.	1Ea.	1Ea.	N3
		BK		711950473		158.00	Ea.	1Ea.	1Ea.	1Ea.	N3
	83"	AL		711950466	✓	108.00	Ea.	1Ea.	1Ea.	1Ea.	N3
		DB		711950470		137.00	Ea.	1Ea.	1Ea.	1Ea.	N3
		BK		711950474		158.00	Ea.	1Ea.	1Ea.	1Ea.	N3
	85"	AL		711950704	✓	108.00	Ea.	1Ea.	1Ea.	1Ea.	N3
		DB		711950705		137.00	Ea.	1Ea.	1Ea.	1Ea.	N3
		BK		711950706		158.00	Ea.	1Ea.	1Ea.	1Ea.	N3
	95"	AL		711950467		140.00	Ea.	1Ea.	1Ea.	1Ea.	N3
		DB		711950471		179.00	Ea.	1Ea.	1Ea.	1Ea.	N3
		BK		711950475		206.00	Ea.	1Ea.	1Ea.	1Ea.	N3
	120"	AL		711950468		204.00	Ea.	1Ea.	1Ea.	1Ea.	N3
						261.00	Ea.	1Ea.	1Ea.	1Ea.	N3
		BK		711950476		299.00	Ea.	1Ea.	1Ea.	1Ea.	N3

NOTE: Custom Aluminum Geared Hinges (models 661 - 681) are subject to an additional \$50.00 fee per order. Customization includes any feature listed on page

# Aluminum Based Continuous Hinges (cont.)

Model	Size	Finish	BHMA	EDP #	Stock Item	List Price	UOM	Order Multiple	Box Qty	Carton Qty	MPG
<b>670 HD UL LL</b> Aluminum Heavy Duty Full Mortise Flush Mount (no door inset) with Lead Lined Option	79"	AL		711950477		135.00	Ea.	1Ea.	1Ea.	1Ea.	N3
		DB		711950481		174.00	Ea.	1Ea.	1Ea.	1Ea.	N3
		BK		711950485		200.00	Ea.	1Ea.	1Ea.	1Ea.	N3
	83"	AL		711950478		135.00	Ea.	1Ea.	1Ea.	1Ea.	N3
		DB		711950482		174.00	Ea.	1Ea.	1Ea.	1Ea.	N3
		BK		711950486		200.00	Ea.	1Ea.	1Ea.	1Ea.	N3
	85"	AL		711950707		135.00	Ea.	1Ea.	1Ea.	1Ea.	N3
		DB		711950708		174.00	Ea.	1Ea.	1Ea.	1Ea.	N3
		BK		711950709		200.00	Ea.	1Ea.	1Ea.	1Ea.	N3
	95"	AL		711950479		177.00	Ea.	1Ea.	1Ea.	1Ea.	N3
		DB		711950483		225.00	Ea.	1Ea.	1Ea.	1Ea.	N3
		BK		711950487		260.00	Ea.	1Ea.	1Ea.	1Ea.	N3
	120"	AL		711950480		258.00	Ea.	1Ea.	1Ea.	1Ea.	N3
		DB		711950484		330.00	Ea.	1Ea.	1Ea.	1Ea.	N3
		BK		711950488		379.00	Ea.	1Ea.	1Ea.	1Ea.	N3
<b>671 HD UL</b> Aluminum Heavy Duty Full Mortise for 3/32" inset doors with Beveled Edge on Frame Leaf	79"	AL		711950489		108.00	Ea.	1Ea.	1Ea.	1Ea.	N3
		DB		711950493		137.00	Ea.	1Ea.	1Ea.	1Ea.	N3
		BK		711950497		158.00	Ea.	1Ea.	1Ea.	1Ea.	N3
	83"	AL		711950490	✓	108.00	Ea.	1Ea.	1Ea.	1Ea.	N3
		DB		711950494		137.00	Ea.	1Ea.	1Ea.	1Ea.	N3
		BK		711950498		158.00	Ea.	1Ea.	1Ea.	1Ea.	N3
	85"	AL		711950710	✓	108.00	Ea.	1Ea.	1Ea.	1Ea.	N3
		DB		711950711		137.00	Ea.	1Ea.	1Ea.	1Ea.	N3
		BK		711950712		158.00	Ea.	1Ea.	1Ea.	1Ea.	N3
	95"	AL		711950491		140.00	Ea.	1Ea.	1Ea.	1Ea.	N3
		DB		711950495		179.00	Ea.	1Ea.	1Ea.	1Ea.	N3
		BK		711950499		206.00	Ea.	1Ea.	1Ea.	1Ea.	N3
	120"	AL		711950492		204.00	Ea.	1Ea.	1Ea.	1Ea.	N3
		DB		711950496		261.00	Ea.	1Ea.	1Ea.	1Ea.	N3
		BK		711950500		299.00	Ea.	1Ea.	1Ea.	1Ea.	N3
<b>671 HD UL LL</b> Aluminum Heavy Duty Full Mortise for 3/32" inset doors with Beveled Edge on Frame Leaf with Lead Lined Option	79"	AL		711950501		135.00	Ea.	1Ea.	1Ea.	1Ea.	N3
		DB		711950505		174.00	Ea.	1Ea.	1Ea.	1Ea.	N3
		BK		711950509		200.00	Ea.	1Ea.	1Ea.	1Ea.	N3
	83"	AL		711950502		135.00	Ea.	1Ea.	1Ea.	1Ea.	N3
		DB		711950506		174.00	Ea.	1Ea.	1Ea.	1Ea.	N3
		BK		711950510		200.00	Ea.	1Ea.	1Ea.	1Ea.	N3
	85"	AL		711950713		135.00	Ea.	1Ea.	1Ea.	1Ea.	N3
		DB		711950714		174.00	Ea.	1Ea.	1Ea.	1Ea.	N3
		BK		711950715		200.00	Ea.	1Ea.	1Ea.	1Ea.	N3
	95"	AL		711950503		177.00	Ea.	1Ea.	1Ea.	1Ea.	N3
		DB		711950507		225.00	Ea.	1Ea.	1Ea.	1Ea.	N3
		BK		711950511		260.00	Ea.	1Ea.	1Ea.	1Ea.	N3
	120"	AL		711950504		258.00	Ea.	1Ea.	1Ea.	1Ea.	N3
		DB		711950508		330.00	Ea.	1Ea.	1Ea.	1Ea.	N3
		BK		711950512		379.00	Ea.	1Ea.	1Ea.	1Ea.	N3
<b>672 HD UL</b> Aluminum Heavy Duty Full Mortise for 3/32" inset doors	79"	AL		711950513		117.00	Ea.	1Ea.	1Ea.	1Ea.	N3
		DB		711950517		150.00	Ea.	1Ea.	1Ea.	1Ea.	N3
		BK		711950521		172.00	Ea.	1Ea.	1Ea.	1Ea.	N3
	83"	AL		711950514		117.00	Ea.	1Ea.	1Ea.	1Ea.	N3
		DB		711950518		150.00	Ea.	1Ea.	1Ea.	1Ea.	N3
		BK		711950522		172.00	Ea.	1Ea.	1Ea.	1Ea.	N3
	85"	AL		711950716		117.00	Ea.	1Ea.	1Ea.	1Ea.	N3
		DB		711950717		150.00	Ea.	1Ea.	1Ea.	1Ea.	N3
		BK		711950718		172.00	Ea.	1Ea.	1Ea.	1Ea.	N3
	95"	AL		711950515		153.00	Ea.	1Ea.	1Ea.	1Ea.	N3
		DB		711950519		195.00	Ea.	1Ea.	1Ea.	1Ea.	N3
		BK		711950523		224.00	Ea.	1Ea.	1Ea.	1Ea.	N3
	120"	AL		711950516		223.00	Ea.	1Ea.	1Ea.	1Ea.	N3
		DB		711950520		285.00	Ea.	1Ea.	1Ea.	1Ea.	N3
		BK		711950524		327.00	Ea.	1Ea.	1Ea.	1Ea.	N3

NOTE: Custom Aluminum Geared Hinges (models 661 - 681) are subject to an additional \$50.00 fee per order. Customization includes any feature listed on page

# Aluminum Based Continuous Hinges (cont.)

# Hinges & Door Accessories

Model	Size	Finish	BHMA	EDP #	Stock Item	List Price	UOM	Order Multiple	Box Qty	Carton Qty	MPG	
<b>672 HD UL LL</b> Aluminum Heavy Duty Full Mortise for 3/32" inset doors with Lead Lined Option	79"	AL		711950525		139.00	Ea.	1Ea.	1Ea.	1Ea.	N3	
		DB		711950529		178.00	Ea.	1Ea.	1Ea.	1Ea.	N3	
		BK		711950533		205.00	Ea.	1Ea.	1Ea.	1Ea.	N3	
	83"	AL		711950526		139.00	Ea.	1Ea.	1Ea.	1Ea.	1Ea.	N3
		DB		711950530		178.00	Ea.	1Ea.	1Ea.	1Ea.	1Ea.	N3
		BK		711950534		205.00	Ea.	1Ea.	1Ea.	1Ea.	1Ea.	N3
	85"	AL		711950719		139.00	Ea.	1Ea.	1Ea.	1Ea.	1Ea.	N3
		DB		711950720		178.00	Ea.	1Ea.	1Ea.	1Ea.	1Ea.	N3
		BK		711950721		205.00	Ea.	1Ea.	1Ea.	1Ea.	1Ea.	N3
	95"	AL		711950527		180.00	Ea.	1Ea.	1Ea.	1Ea.	1Ea.	N3
		DB		711950531		231.00	Ea.	1Ea.	1Ea.	1Ea.	1Ea.	N3
		BK		711950535		265.00	Ea.	1Ea.	1Ea.	1Ea.	1Ea.	N3
	120"	AL		711950528		264.00	Ea.	1Ea.	1Ea.	1Ea.	1Ea.	N3
		DB		711950532		338.00	Ea.	1Ea.	1Ea.	1Ea.	1Ea.	N3
		BK		711950536		388.00	Ea.	1Ea.	1Ea.	1Ea.	1Ea.	N3
<b>673 HD UL</b> Aluminum Heavy Duty Full Mortise Flush Mount (no door inset)	79"	AL		711950537		117.00	Ea.	1Ea.	1Ea.	1Ea.	N3	
		DB		711950541		150.00	Ea.	1Ea.	1Ea.	1Ea.	1Ea.	N3
		BK		711950545		172.00	Ea.	1Ea.	1Ea.	1Ea.	1Ea.	N3
	83"	AL		711950538	✓	117.00	Ea.	1Ea.	1Ea.	1Ea.	1Ea.	N3
		DB		711950542		150.00	Ea.	1Ea.	1Ea.	1Ea.	1Ea.	N3
		BK		711950546		172.00	Ea.	1Ea.	1Ea.	1Ea.	1Ea.	N3
	85"	AL		711950722	✓	117.00	Ea.	1Ea.	1Ea.	1Ea.	1Ea.	N3
		DB		711950723		150.00	Ea.	1Ea.	1Ea.	1Ea.	1Ea.	N3
		BK		711950724		172.00	Ea.	1Ea.	1Ea.	1Ea.	1Ea.	N3
	95"	AL		711950539	✓	153.00	Ea.	1Ea.	1Ea.	1Ea.	1Ea.	N3
		DB		711950543		195.00	Ea.	1Ea.	1Ea.	1Ea.	1Ea.	N3
		BK		711950547		224.00	Ea.	1Ea.	1Ea.	1Ea.	1Ea.	N3
	120"	AL		711950540		223.00	Ea.	1Ea.	1Ea.	1Ea.	1Ea.	N3
		DB		711950544		195.00	Ea.	1Ea.	1Ea.	1Ea.	1Ea.	N3
		BK		711950548		327.00	Ea.	1Ea.	1Ea.	1Ea.	1Ea.	N3
<b>673 HD UL LL</b> Aluminum Heavy Duty Full Mortise Flush Mount (no door inset) with Lead Lined Option	79"	AL		711950549		139.00	Ea.	1Ea.	1Ea.	1Ea.	N3	
		DB		711950553		178.00	Ea.	1Ea.	1Ea.	1Ea.	1Ea.	N3
		BK		711950557		205.00	Ea.	1Ea.	1Ea.	1Ea.	1Ea.	N3
	83"	AL		711950550		139.00	Ea.	1Ea.	1Ea.	1Ea.	1Ea.	N3
		DB		711950554		178.00	Ea.	1Ea.	1Ea.	1Ea.	1Ea.	N3
		BK		711950558		205.00	Ea.	1Ea.	1Ea.	1Ea.	1Ea.	N3
	85"	AL		711950725		139.00	Ea.	1Ea.	1Ea.	1Ea.	1Ea.	N3
		DB		711950726		178.00	Ea.	1Ea.	1Ea.	1Ea.	1Ea.	N3
		BK		711950727		205.00	Ea.	1Ea.	1Ea.	1Ea.	1Ea.	N3
	95"	AL		711950551		180.00	Ea.	1Ea.	1Ea.	1Ea.	1Ea.	N3
		DB		711950555		231.00	Ea.	1Ea.	1Ea.	1Ea.	1Ea.	N3
		BK		711950559		265.00	Ea.	1Ea.	1Ea.	1Ea.	1Ea.	N3
	120"	AL		711950552		264.00	Ea.	1Ea.	1Ea.	1Ea.	1Ea.	N3
		DB		711950556		338.00	Ea.	1Ea.	1Ea.	1Ea.	1Ea.	N3
		BK		711950560		388.00	Ea.	1Ea.	1Ea.	1Ea.	1Ea.	N3
<b>674 HD UL</b> Aluminum Heavy Duty Full Mortise Flush Mount (no door inset) Swing Clear	79"	AL		711950561		204.00	Ea.	1Ea.	1Ea.	1Ea.	N3	
		DB		711950565		261.00	Ea.	1Ea.	1Ea.	1Ea.	1Ea.	N3
		BK		711950569		299.00	Ea.	1Ea.	1Ea.	1Ea.	1Ea.	N3
	83"	AL		711950562	✓	204.00	Ea.	1Ea.	1Ea.	1Ea.	1Ea.	N3
		DB		711950566		261.00	Ea.	1Ea.	1Ea.	1Ea.	1Ea.	N3
		BK		711950570		299.00	Ea.	1Ea.	1Ea.	1Ea.	1Ea.	N3
	85"	AL		711950728	✓	204.00	Ea.	1Ea.	1Ea.	1Ea.	1Ea.	N3
		DB		711950729		261.00	Ea.	1Ea.	1Ea.	1Ea.	1Ea.	N3
		BK		711950730		299.00	Ea.	1Ea.	1Ea.	1Ea.	1Ea.	N3
	95"	AL		711950563		247.00	Ea.	1Ea.	1Ea.	1Ea.	1Ea.	N3
		DB		711950567		339.00	Ea.	1Ea.	1Ea.	1Ea.	1Ea.	N3
		BK		711950571		389.00	Ea.	1Ea.	1Ea.	1Ea.	1Ea.	N3
	120"	AL		711950564		387.00	Ea.	1Ea.	1Ea.	1Ea.	1Ea.	N3
		DB		711950568		495.00	Ea.	1Ea.	1Ea.	1Ea.	1Ea.	N3
		BK		711950572		569.00	Ea.	1Ea.	1Ea.	1Ea.	1Ea.	N3

NOTE: Custom Aluminum Geared Hinges (models 661 - 681) are subject to an additional \$50.00 fee per order. Customization includes any feature listed on page

# Aluminum Based Continuous Hinges (cont.)

# Hinges & Door Accessories

Model	Size	Finish	BHMA	EDP #	Stock Item	List Price	UOM	Order Multiple	Box Qty	Carton Qty	MPG
<b>674 HD UL LL</b> Aluminum Heavy Duty Full Mortise Flush Mount (no door inset) Swing Clear with Lead Lined Option	79"	AL		711950573		231.00	Ea.	1Ea.	1Ea.	1Ea.	N3
		DB		711950577		296.00	Ea.	1Ea.	1Ea.	1Ea.	N3
		BK		711950581		340.00	Ea.	1Ea.	1Ea.	1Ea.	N3
	83"	AL		711950574		231.00	Ea.	1Ea.	1Ea.	1Ea.	N3
		DB		711950578		296.00	Ea.	1Ea.	1Ea.	1Ea.	N3
		BK		711950582		340.00	Ea.	1Ea.	1Ea.	1Ea.	N3
	85"	AL		711950731		231.00	Ea.	1Ea.	1Ea.	1Ea.	N3
		DB		711950732		296.00	Ea.	1Ea.	1Ea.	1Ea.	N3
		BK		711950733		340.00	Ea.	1Ea.	1Ea.	1Ea.	N3
	95"	AL		711950575		300.00	Ea.	1Ea.	1Ea.	1Ea.	N3
		DB		711950579		384.00	Ea.	1Ea.	1Ea.	1Ea.	N3
		BK		711950583		441.00	Ea.	1Ea.	1Ea.	1Ea.	N3
	120"	AL		711950576		438.00	Ea.	1Ea.	1Ea.	1Ea.	N3
		DB		711950580		561.00	Ea.	1Ea.	1Ea.	1Ea.	N3
		BK		711950584		645.00	Ea.	1Ea.	1Ea.	1Ea.	N3
<b>675 HD UL</b> Aluminum Heavy Duty Half Surface for 1/16" inset doors Swing Clear	79"	AL		711950585		297.00	Ea.	1Ea.	1Ea.	1Ea.	N3
		DB		711950589		380.00	Ea.	1Ea.	1Ea.	1Ea.	N3
		BK		711950593		437.00	Ea.	1Ea.	1Ea.	1Ea.	N3
	83"	AL		711950586		297.00	Ea.	1Ea.	1Ea.	1Ea.	N3
		DB		711950590		380.00	Ea.	1Ea.	1Ea.	1Ea.	N3
		BK		711950594		437.00	Ea.	1Ea.	1Ea.	1Ea.	N3
	85"	AL		711950734		297.00	Ea.	1Ea.	1Ea.	1Ea.	N3
		DB		711950735		380.00	Ea.	1Ea.	1Ea.	1Ea.	N3
		BK		711950736		437.00	Ea.	1Ea.	1Ea.	1Ea.	N3
	95"	AL		711950587		387.00	Ea.	1Ea.	1Ea.	1Ea.	N3
		DB		711950591		495.00	Ea.	1Ea.	1Ea.	1Ea.	N3
		BK		711950595		568.00	Ea.	1Ea.	1Ea.	1Ea.	N3
	120"	AL		711950588		565.00	Ea.	1Ea.	1Ea.	1Ea.	N3
		DB		711950592		723.00	Ea.	1Ea.	1Ea.	1Ea.	N3
		BK		711950596		831.00	Ea.	1Ea.	1Ea.	1Ea.	N3
<b>676 HD UL</b> Aluminum Heavy Duty Half Surface for center hung doors with Finger Guards	79"	AL		711950597		217.00	Ea.	1Ea.	1Ea.	1Ea.	N3
		DB		711950601		278.00	Ea.	1Ea.	1Ea.	1Ea.	N3
		BK		711950605		319.00	Ea.	1Ea.	1Ea.	1Ea.	N3
	83"	AL		711950598		217.00	Ea.	1Ea.	1Ea.	1Ea.	N3
		DB		711950602		278.00	Ea.	1Ea.	1Ea.	1Ea.	N3
		BK		711950606		319.00	Ea.	1Ea.	1Ea.	1Ea.	N3
	85"	AL		711950737		217.00	Ea.	1Ea.	1Ea.	1Ea.	N3
		DB		711950738		278.00	Ea.	1Ea.	1Ea.	1Ea.	N3
		BK		711950739		319.00	Ea.	1Ea.	1Ea.	1Ea.	N3
	95"	AL		711950599		282.00	Ea.	1Ea.	1Ea.	1Ea.	N3
		DB		711950603		361.00	Ea.	1Ea.	1Ea.	1Ea.	N3
		BK		711950607		415.00	Ea.	1Ea.	1Ea.	1Ea.	N3
	120"	AL		711950600		411.00	Ea.	1Ea.	1Ea.	1Ea.	N3
		DB		711950604		528.00	Ea.	1Ea.	1Ea.	1Ea.	N3
		BK		711950608		607.00	Ea.	1Ea.	1Ea.	1Ea.	N3
<b>677 HD UL</b> Aluminum Heavy Duty Half Surface for 9/32" inset doors	79"	AL		711950609		244.00	Ea.	1Ea.	1Ea.	1Ea.	N3
		DB		711950613		313.00	Ea.	1Ea.	1Ea.	1Ea.	N3
		BK		711950617		360.00	Ea.	1Ea.	1Ea.	1Ea.	N3
	83"	AL		711950610		244.00	Ea.	1Ea.	1Ea.	1Ea.	N3
		DB		711950614		313.00	Ea.	1Ea.	1Ea.	1Ea.	N3
		BK		711950618		360.00	Ea.	1Ea.	1Ea.	1Ea.	N3
	85"	AL		711950740		244.00	Ea.	1Ea.	1Ea.	1Ea.	N3
		DB		711950741		313.00	Ea.	1Ea.	1Ea.	1Ea.	N3
		BK		711950742		360.00	Ea.	1Ea.	1Ea.	1Ea.	N3
	95"	AL		711950611		317.00	Ea.	1Ea.	1Ea.	1Ea.	N3
		DB		711950615		406.00	Ea.	1Ea.	1Ea.	1Ea.	N3
		BK		711950619		468.00	Ea.	1Ea.	1Ea.	1Ea.	N3
	120"	AL		711950612		464.00	Ea.	1Ea.	1Ea.	1Ea.	N3
		DB		711950616		594.00	Ea.	1Ea.	1Ea.	1Ea.	N3
		BK		711950620		684.00	Ea.	1Ea.	1Ea.	1Ea.	N3

NOTE: Custom Aluminum Geared Hinges (models 661 - 681) are subject to an additional \$50.00 fee per order. Customization includes any feature listed on page

# Aluminum Based Continuous Hinges (cont.)

# Hinges & Door Accessories

Model	Size	Finish	BHMA	EDP #	Stock Item	List Price	UOM	Order Multiple	Box Qty	Carton Qty	MPG
<b>678 HD UL</b> Aluminum Heavy Duty Half Surface for 9/32" inset doors	79"	AL		711950621		244.00	Ea.	1Ea.	1Ea.	1Ea.	N3
		DB		711950625		313.00	Ea.	1Ea.	1Ea.	1Ea.	N3
		BK		711950629		360.00	Ea.	1Ea.	1Ea.	1Ea.	N3
	83"	AL		711950622		244.00	Ea.	1Ea.	1Ea.	1Ea.	N3
		DB		711950626		313.00	Ea.	1Ea.	1Ea.	1Ea.	N3
		BK		711950630		360.00	Ea.	1Ea.	1Ea.	1Ea.	N3
	85"	AL		711950743		244.00	Ea.	1Ea.	1Ea.	1Ea.	N3
		DB		711950744		313.00	Ea.	1Ea.	1Ea.	1Ea.	N3
		BK		711950745		360.00	Ea.	1Ea.	1Ea.	1Ea.	N3
	95"	AL		711950623		317.00	Ea.	1Ea.	1Ea.	1Ea.	N3
		DB		711950627		406.00	Ea.	1Ea.	1Ea.	1Ea.	N3
		BK		711950631		468.00	Ea.	1Ea.	1Ea.	1Ea.	N3
	120"	AL		711950624		464.00	Ea.	1Ea.	1Ea.	1Ea.	N3
		DB		711950628		594.00	Ea.	1Ea.	1Ea.	1Ea.	N3
		BK		711950632		683.00	Ea.	1Ea.	1Ea.	1Ea.	N3
<b>679 HD UL</b> Aluminum Heavy Duty Half Surface for 3/32" inset doors	79"	AL		711950633		168.00	Ea.	1Ea.	1Ea.	1Ea.	N3
		DB		711950637		215.00	Ea.	1Ea.	1Ea.	1Ea.	N3
		BK		711950641		247.00	Ea.	1Ea.	1Ea.	1Ea.	N3
	83"	AL		711950634	✓	168.00	Ea.	1Ea.	1Ea.	1Ea.	N3
		DB		711950638		215.00	Ea.	1Ea.	1Ea.	1Ea.	N3
		BK		711950642		247.00	Ea.	1Ea.	1Ea.	1Ea.	N3
	85"	AL		711950746	✓	168.00	Ea.	1Ea.	1Ea.	1Ea.	N3
		DB		711950747		215.00	Ea.	1Ea.	1Ea.	1Ea.	N3
		BK		711950748		247.00	Ea.	1Ea.	1Ea.	1Ea.	N3
	95"	AL		711950635		218.00	Ea.	1Ea.	1Ea.	1Ea.	N3
		DB		711950639		279.00	Ea.	1Ea.	1Ea.	1Ea.	N3
		BK		711950643		321.00	Ea.	1Ea.	1Ea.	1Ea.	N3
	120"	AL		711950636		318.00	Ea.	1Ea.	1Ea.	1Ea.	N3
		DB		711950640		407.00	Ea.	1Ea.	1Ea.	1Ea.	N3
		BK		711950644		468.00	Ea.	1Ea.	1Ea.	1Ea.	N3
<b>680 HD UL</b> Aluminum Heavy Duty Half Surface - double egress and center hung conversions	79"	AL		711950645		194.00	Ea.	1Ea.	1Ea.	1Ea.	N3
		DB		711950649		248.00	Ea.	1Ea.	1Ea.	1Ea.	N3
		BK		711950653		285.00	Ea.	1Ea.	1Ea.	1Ea.	N3
	83"	AL		711950646	✓	194.00	Ea.	1Ea.	1Ea.	1Ea.	N3
		DB		711950650		248.00	Ea.	1Ea.	1Ea.	1Ea.	N3
		BK		711950654		285.00	Ea.	1Ea.	1Ea.	1Ea.	N3
	85"	AL		711950749	✓	194.00	Ea.	1Ea.	1Ea.	1Ea.	N3
		DB		711950750		248.00	Ea.	1Ea.	1Ea.	1Ea.	N3
		BK		711950751		285.00	Ea.	1Ea.	1Ea.	1Ea.	N3
	95"	AL		711950647		252.00	Ea.	1Ea.	1Ea.	1Ea.	N3
		DB		711950651		323.00	Ea.	1Ea.	1Ea.	1Ea.	N3
		BK		711950655		371.00	Ea.	1Ea.	1Ea.	1Ea.	N3
	120"	AL		711950648		369.00	Ea.	1Ea.	1Ea.	1Ea.	N3
		DB		711950652		541.00	Ea.	1Ea.	1Ea.	1Ea.	N3
		BK		711950656		541.00	Ea.	1Ea.	1Ea.	1Ea.	N3
<b>681 HD UL</b> Aluminum Heavy Duty Full Surface for 1/16" inset doors	79"	AL		711950657		166.00	Ea.	1Ea.	1Ea.	1Ea.	N3
		DB		711950661		213.00	Ea.	1Ea.	1Ea.	1Ea.	N3
		BK		711950665		244.00	Ea.	1Ea.	1Ea.	1Ea.	N3
	83"	AL		711950658		166.00	Ea.	1Ea.	1Ea.	1Ea.	N3
		DB		711950662		213.00	Ea.	1Ea.	1Ea.	1Ea.	N3
		BK		711950666		244.00	Ea.	1Ea.	1Ea.	1Ea.	N3
	85"	AL		711950752	✓	166.00	Ea.	1Ea.	1Ea.	1Ea.	N3
		DB		711950753		213.00	Ea.	1Ea.	1Ea.	1Ea.	N3
		BK		711950754		244.00	Ea.	1Ea.	1Ea.	1Ea.	N3
	95"	AL		711950659	✓	216.00	Ea.	1Ea.	1Ea.	1Ea.	N3
		DB		711950663		276.00	Ea.	1Ea.	1Ea.	1Ea.	N3
		BK		711950667		317.00	Ea.	1Ea.	1Ea.	1Ea.	N3
	120"	AL		711950660		315.00	Ea.	1Ea.	1Ea.	1Ea.	N3
		DB		711950664		403.00	Ea.	1Ea.	1Ea.	1Ea.	N3
		BK		711950668		463.00	Ea.	1Ea.	1Ea.	1Ea.	N3

NOTE: Custom Aluminum Geared Hinges (models 661 - 681) are subject to an additional \$50.00 fee per order. Customization includes any feature listed on page



# Aluminum Based Continuous Hinges Extras





# Hinges & Door Accessories

Model	Size	Finish	BHMA	EDP #	Stock Item	List Price	UOM	Order Multiple	Box Qty	Carton Qty	MPG
Hospital Tip (HTCUT) Cut Only *661HD & 662HD Models only						52.59	EA	1EA			
Hospital Tip Cap (HTCAP)						225.38	EA	1EA			
Fire Studs (FS) 3 Hour Fire Rating						67.61	EA	1EA			
EPT (Electric Power Transfer)						75.13	EA	1EA			
CE-12EA - Easy Access Panel						420.71	EA	1EA			
CE-12R - Removable Section						510.87	EA	1EA			
Concealed Switch (CS)						225.38	EA	1EA			
School Option (SO)						52.59	EA	1EA			
Dutch Door (DD)						75.13	EA	1EA			
Lead Lined (LL)						72.90	EA	1EA			
Cut - Custom Length						52.59	EA	1EA			
Full Mortise Hardware Pack		AL		711477840	✓	38.32	Pack	1Pack			
Full Mortise Hardware Pack		DB / BK		711477841	✓	38.32	Pack	1Pack			
Full Surface Hardware Pack		AL		711477842	✓	57.10	Pack	1Pack			
Full Surface Hardware Pack		DB / BK		711477843	✓	57.10	Pack	1Pack			
Half Surface Hardware Pack		AL		711477844	✓	57.10	Pack	1Pack			
Half Surface Hardware Pack		DB / BK		711477845		57.10	Pack	1Pack			
681HD Series Hardware Pack		AL		711950761		57.10	Pack	1Pack			
681HD Series Hardware Pack		DB / BK		711950762		57.10	Pack	1Pack			
Wood Screws (500 ea bulk box)		AL		711950763		280.00	Box	1Box			
Wood Screws (500 ea bulk box)		DB / BK		711950764		195.33	Box	1Box			
Security Screw: #12-24 x 3/4" Pin-in torx flat head, undercut, self-drilling				711950770		45.08	Pack	1Pack			
				*Specify Hinge Model, Length, Finish and Quantity"							
Security Screw: #12 x 1-1/2" Pin-in torx flat head, undercut wood security screw.				711950771		45.08	Pack	1Pack			
				*Specify Hinge Model, Length, Finish and Quantity"							
Shim 83" (Aluminum)		NA		711950765	✓	45.08	EA	1EA	1Set	1Set	
Shim 120" (Aluminum)		NA		711950766	✓	90.15	EA	1EA	1Set	1Set	
DL1 -Door Leaf Cover: Models 665HD, 675HD, 676HD, 677HD and 678HD				711950767		67.61	EA	1EA	1Set	1Set	
				*Specify Hinge Model, Length, Finish and Quantity"							
DL2- Door Leaf Cover: Models 663HD, 664HD, 679HD, 680HD, and 681HD				711950768		67.61	EA	1EA	1Set	1Set	
				*Specify length and finish at time of order"							
FL1 - Frame Leaf Cover (Model 664HD)				711950769		67.61	EA	1EA	1Set	1Set	
				*Specify length and finish at time of order"							

NOTE: Custom Aluminum Geared Hinges (models 661 - 681) are subject to an additional \$50.00 fee per order. Customization includes any feature listed on page

## Two Knuckle Hinges

## Hinges & Door Accessories

	Model	Size	Finish	BHMA	EDP #	Stock Item	List Price	UOM	Order Multiple	Box Qty	Carton Qty	MPG
	<b>CB0701RH</b> Heavy Weight Steel 2 Knuckle Concealed Bearing Full Mortise Hinge	4.5"x4.5"	P	600	711834358		150.98	Ea.	1 Ea. 1 Ea.	3 Ea. 3 Ea.	30 Ea. 30 Ea.	
	<b>CB0701LH</b> Heavy Weight Steel 2 Knuckle Concealed Bearing Full Mortise Hinge	4.5"x4.5"	P	600	711834382		150.98	Ea.	1 Ea. 1 Ea.	3 Ea. 3 Ea.	30 Ea. 30 Ea.	
	<b>CB0761RH</b> Heavy Weight Stainless Steel 2 Knuckle Concealed Bearing Full Mortise Hinge	4.5"x4.5"	32	629	711834366		346.24	Ea.	1 Ea.	3 Ea.	30 Ea.	
			32D	630	711834374		343.35	Ea.	1 Ea.	3 Ea.	30 Ea.	
	<b>CB0761LH</b> Heavy Weight Stainless Steel 2 Knuckle Concealed Bearing Full Mortise Hinge	4.5"x4.5"	32	629	711834390		346.24	Ea.	1 Ea.	3 Ea.	30 Ea.	
			32D	630	711834408		343.35	Ea.	1 Ea.	3 Ea.	30 Ea.	





## Residential Hinges

	Model	Size	Finish	BHMA	EDP #	Stock Item	List Price	UOM	Order Multiple	Box Qty	Carton Qty	MPG
	<b>741</b> Square Corner Residential Hinges, No Screws	3"x3"	4	633	711083021	✓	17.27	Ea.	60 Ea.	60 Ea.	120 Ea.	
			15	646	711080134	✓	24.76	Ea.	30 Ea.	30 Ea.	150 Ea.	
		3.5"x3.5"	4	633	711083022	✓	15.95	Ea.	75 Ea.	N/A	75 Ea.	
			15	646	711080244	✓	16.65	Ea.	60 Ea.	N/A	60 Ea.	
			4"x4"	4	633	711083023	✓	16.65	Ea.	40 Ea.	N/A	40 Ea.
15	646	711080354		✓	16.86	Ea.	30 Ea.	30 Ea.	60 Ea.			
	<b>RD741BA</b> 1/4" Radius Corner Residential Hinges, Bulk Asssembled, No Screws	3.5"x3.5"	4	4	711082600	✓	11.51	Ea.	100 Ea.	100 Ea.	100 Ea.	
			10BL	10BL	711082616	✓	27.82	Ea.	100 Ea.	100 Ea.	100 Ea.	
			15	646	711082617	✓	17.13	Ea.	100 Ea.	100 Ea.	100 Ea.	
			26D	652	711082604	✓	19.56	Ea.	100 Ea.	100 Ea.	100 Ea.	
		4"x4"	4	633	711082601	✓	16.65	Ea.	100 Ea.	100 Ea.	100 Ea.	
			10BL		711082607	✓	31.56	Ea.	100 Ea.	100 Ea.	100 Ea.	
			15	646	711082608	✓	20.53	Ea.	100 Ea.	100 Ea.	100 Ea.	
			26D	652	711082610	✓	22.20	Ea.	100 Ea.	100 Ea.	100 Ea.	
			3.5"x3.5"	4	633	711082622	✓	15.61	Ea.	100 Ea.	100 Ea.	100 Ea.
10BL		711082618		✓	28.02	Ea.	100 Ea.	100 Ea.	100 Ea.			
15	646	711082619		✓	26.71	Ea.	100 Ea.	100 Ea.	100 Ea.			
26D	652	711082628		✓	17.55	Ea.	100 Ea.	100 Ea.	100 Ea.			
4"x4"	4	633		711083652	✓	12.62	Ea.	100 Ea.	100 Ea.	100 Ea.		
	<b>763</b> 3/4" x 9 (Type 17 Fly Cut)	4	4	633	711081462	✓	116.74	Box	1 Box	600 Ea.	600 Ea.	
			10BL		711081612	✓	97.18	Box	1 Box	600 Ea.	600 Ea.	
			15	646	711081613	✓	170.15	Box	1 Box	600 Ea.	600 Ea.	
			26D	652	711081615	✓	124.79	Box	1 Box	600 Ea.	600 Ea.	

### NOTES:



- \* Available in square, 1/4" and 5/8" radius corner
- \* Must order screws separately / screws are NOT including in price of hinge
- \* Five knuckle full mortise design
- \* Non-rising removable flush pin

# Detention Hinges

Model	Size	Finish	BHMA	EDP #	Stock Item	List Price	UOM	Order Multiple	Box Qty	Carton Qty	MPG
 <b>850</b> Heavy Gauge Full Surface Hinge	2"x2"	PS		711127400	✓	8.23	Ea.	10 Ea.	10 Ea.	200 Ea.	
	2.5"x2.5"	PS		711127600	✓	11.97	Ea.	10 Ea.	10 Ea.	200 Ea.	
	3"x3"	PS		711127850	✓	15.79	Ea.	2 Ea.	2 Ea.	40 Ea.	
	3.5"x3.5"	PS		711128100	✓	23.49	Ea.	2 Ea.	2 Ea.	50 Ea.	
	4"x4"	PS		711128350	✓	30.16	Ea.	2 Ea.	2 Ea.	40 Ea.	
	4.5"x4.5"	PS		711128450	✓	39.16	Ea.	2 Ea.	2 Ea.	40 Ea.	
	5"x5"	PS		711128550	✓	57.66	Ea.	2 Ea.	2 Ea.	40 Ea.	
	6"x6"	PS		711128750	✓	90.84	Ea.	2 Ea.	2 Ea.	20 Ea.	
 <b>BB852</b> Triple Weight Prison Hinge Furnished No Holes Not Swaged	5"x6"	P	600	711029388	✓	369.30	Ea.	1 Ea.	2 Ea.	10 Ea.	
 <b>BB855</b> Double Weight Prison Hinge Furnished No Holes Not Swaged	5"x6"	P	600	711029468	✓	314.47	Ea.	1 Ea.	2 Ea.	10 Ea.	
 <b>1592-4</b> <b>HT1592-4</b>				711351490	✓	11.26	1 Pack	2 Ea.	5 Packs	10 Ea.	
	2-3/4"	26D		711351616	✓	12.90	1 Pack	2 Ea.	5 Packs	10 Ea.	

# Three Knuckle Concealed Bearing Architectural Hinges

# Hinges & Door Accessories

Model	Size	Finish	BHMA	EDP #	Stock Item	List Price	UOM	Order Multiple	Box Qty	Carton Qty	MPG
 <b>1900R</b> Steel Full Mortise Std Weight Hinge	3.5"x3	26D	652	711940001		25.91	Ea.	1Ea	2 Ea.	100 Ea.	EO
	3.5"x3.5"	P	600	711940002		12.93	Ea.	1Ea	2 Ea.	100 Ea.	EO
		4	633	711940003		12.93	Ea.	1Ea	2 Ea.	100 Ea.	EO
		10	639	711940004		17.26	Ea.	1Ea	2 Ea.	100 Ea.	EO
		26D	652	711940005		25.91	Ea.	1Ea	2 Ea.	100 Ea.	EO
		10A	641	711940006		30.24	Ea.	1Ea	2 Ea.	100 Ea.	EO
		3	632	711940007		30.24	Ea.	1Ea	2 Ea.	100 Ea.	EO
	4"x3.5"	26	651	711940008		30.24	Ea.	1Ea	2 Ea.	100 Ea.	EO
		26D	652	711940009		27.84	Ea.	1Ea	3 Ea.	48 Ea.	EO
	4"x4"	26	651	711940010		36.50	Ea.	1Ea	3 Ea.	48 Ea.	EO
		P	600	711940011		17.29	Ea.	1Ea	3 Ea.	48 Ea.	EO
	4"x4"	10A	641	711940013		32.67	Ea.	1Ea	3 Ea.	48 Ea.	EO
		3	632	711940014		32.67	Ea.	1Ea	3 Ea.	48 Ea.	EO
		P	600	711940015		22.07	Ea.	1Ea	3 Ea.	48 Ea.	EO
	4.5"x4"	4	633	711940016		22.07	Ea.	1Ea	3 Ea.	48 Ea.	EO
		10	639	711940017		25.94	Ea.	1Ea	3 Ea.	48 Ea.	EO
		26D	652	711940018		32.55	Ea.	1Ea	3 Ea.	48 Ea.	EO
		26	651	711940019		39.39	Ea.	1Ea	3 Ea.	48 Ea.	EO
		3	632	711940020		39.39	Ea.	1Ea	3 Ea.	48 Ea.	EO
		10A	641	711940021		39.39	Ea.	1Ea	3 Ea.	48 Ea.	EO
		10B	640	711940022		38.75	Ea.	1Ea	3 Ea.	48 Ea.	EO
		PCW	-	711940023		24.01	Ea.	1Ea	3 Ea.	48 Ea.	EO
	4.5"x4.5"	4	633	711940024		22.07	Ea.	1Ea	3 Ea.	48 Ea.	EO
		10	639	711940025		25.39	Ea.	1Ea	3 Ea.	48 Ea.	EO
		26D	652	711940026		32.81	Ea.	1Ea	3 Ea.	48 Ea.	EO
		26	651	711940027		39.22	Ea.	1Ea	3 Ea.	48 Ea.	EO
		3	632	711940028		39.39	Ea.	1Ea	3 Ea.	48 Ea.	EO
		10A	641	711940029		39.39	Ea.	1Ea	3 Ea.	48 Ea.	EO
		10B	640	711940030		39.39	Ea.	1Ea	3 Ea.	48 Ea.	EO
		5"x4"	26D	652	711940031		74.01	Ea.	1Ea	3 Ea.	30 Ea.
5"x4.5"	26D	652	711940032		72.11	Ea.	1Ea	3 Ea.	30 Ea.	EO	
 <b>1900R NRP</b> Steel Full Mortise Std Weight Hinge Non Removable Pin	5"x5"	P	600	711940033		57.68	Ea.	1Ea	3 Ea.	30 Ea.	EO
	3.5"x3.5"	26D	652	711940034		34.49	Ea.	1Ea	2 Ea.	100 Ea.	EO
		26D	652	711940035		41.13	Ea.	1Ea	3 Ea.	48 Ea.	EO
	4.5"x4"	3	632	711940036		47.97	Ea.	1Ea	3 Ea.	48 Ea.	EO
		10	639	711940037		34.52	Ea.	1Ea	3 Ea.	48 Ea.	EO
		10A	641	711940038		47.97	Ea.	1Ea	3 Ea.	48 Ea.	EO
		10B	640	711940039		47.33	Ea.	1Ea	3 Ea.	48 Ea.	EO
	4.5"x4.5"	PCW	-	711940040		35.56	Ea.	1Ea	3 Ea.	48 Ea.	EO
		P	600	711940041		32.59	Ea.	1Ea	3 Ea.	48 Ea.	EO
		10	639	711940042		33.97	Ea.	1Ea	3 Ea.	48 Ea.	EO
		26D	652	711940043		41.39	Ea.	1Ea	3 Ea.	48 Ea.	EO
		10B	640	711940044		47.97	Ea.	1Ea	3 Ea.	48 Ea.	EO
		26	651	711940045		47.80	Ea.	1Ea	3 Ea.	48 Ea.	EO
		10A	641	711940046		47.97	Ea.	1Ea	3 Ea.	48 Ea.	EO

All prices are for items furnished with screws (as specified in catalog) unless otherwise stated in price list.  
 \* To price other finishes on architectural items – See pricing extras.

\*\* For conversion pins and decorative tips – See Miscellaneous Architectural Parts.  
 (X) Item must be ordered in these increments.

# Three Knuckle Concealed Bearing Architectural Hinges (cont.) Hinges & Door Accessories

Model	Size	Finish	BHMA	EDP #	Stock Item	List Price	UOM	Order Multiple	Box Qty	Carton Qty	MPG	
 <b>CB1900R</b> Steel Full Mortise Std Weight Hinge	3.5"X3.5"	4	633	711940088		49.00	Ea.	1Ea	2 Ea.	100 Ea.	EO	
		LA	-	711940089		49.00	Ea.	1Ea	2 Ea.	100 Ea.	EO	
		3	632	711940090		61.98	Ea.	1Ea	2 Ea.	100 Ea.	EO	
		26D	652	711940091		54.77	Ea.	1Ea	2 Ea.	100 Ea.	EO	
		10A	641	711940092		61.98	Ea.	1Ea	2 Ea.	100 Ea.	EO	
		26	651	711940093		61.98	Ea.	1Ea	2 Ea.	100 Ea.	EO	
	4"x4"	26D	652	711940094		51.91	Ea.	1Ea	3 Ea.	48 Ea.	EO	
		3	632	711940095		66.34	Ea.	1Ea	3 Ea.	48 Ea.	EO	
	4.5"X4"	P	600	711940096		50.96	Ea.	1Ea	3 Ea.	48 Ea.	EO	
		4	633	711940097		49.98	Ea.	1Ea	3 Ea.	48 Ea.	EO	
		10	639	711940098		53.84	Ea.	1Ea	3 Ea.	48 Ea.	EO	
		26D	652	711940099	✓	53.84	Ea.	1Ea	3 Ea.	48 Ea.	EO	
		26	651	711940100		64.41	Ea.	1Ea	3 Ea.	48 Ea.	EO	
		3	632	711940101		72.11	Ea.	1Ea	3 Ea.	48 Ea.	EO	
		10A	641	711940102		64.41	Ea.	1Ea	3 Ea.	48 Ea.	EO	
		10B	640	711940103		64.41	Ea.	1Ea	3 Ea.	48 Ea.	EO	
		15	646	711940104		59.58	Ea.	1Ea	3 Ea.	48 Ea.	EO	
		4.5"X4.5"	P	600	711940105		46.14	Ea.	1Ea	3 Ea.	48 Ea.	EO
			4	633	711940106		49.98	Ea.	1Ea	3 Ea.	48 Ea.	EO
	10		639	711940107		53.84	Ea.	1Ea	3 Ea.	48 Ea.	EO	
	26D		652	711940108	✓	53.84	Ea.	1Ea	3 Ea.	48 Ea.	EO	
	26		651	711940109		64.41	Ea.	1Ea	3 Ea.	48 Ea.	EO	
	3		632	711940110		72.11	Ea.	1Ea	3 Ea.	48 Ea.	EO	
	10A		641	711940111		74.01	Ea.	1Ea	3 Ea.	48 Ea.	EO	
	10B		640	711940112	✓	74.01	Ea.	1Ea	3 Ea.	48 Ea.	EO	
	15		646	711940113		75.95	Ea.	1Ea	3 Ea.	48 Ea.	EO	
	5"X4"		P	600	711940114		81.73	Ea.	1Ea	3 Ea.	30 Ea.	EO
		26D	652	711940115		81.73	Ea.	1Ea	3 Ea.	30 Ea.	EO	
5"X4.5"	P	600	711940116		81.73	Ea.	1Ea	3 Ea.	30 Ea.	EO		
	26D	652	711940117	✓	81.73	Ea.	1Ea	3 Ea.	30 Ea.	EO		
	26	651	711940118		110.58	Ea.	1Ea	3 Ea.	30 Ea.	EO		
	3	632	711940119		110.58	Ea.	1Ea	3 Ea.	30 Ea.	EO		
	10B	640	711940120		110.58	Ea.	1Ea	3 Ea.	30 Ea.	EO		
5"X5"	4	633	711940122		81.73	Ea.	1Ea	3 Ea.	30 Ea.	EO		
	26D	652	711940123		81.73	Ea.	1Ea	3 Ea.	30 Ea.	EO		
	10A	641	711940124		110.58	Ea.	1Ea	3 Ea.	30 Ea.	EO		
	26	651	711940125		110.58	Ea.	1Ea	3 Ea.	30 Ea.	EO		

# Three Knuckle Concealed Bearing Architectural Hinges (cont.) Hinges & Door Accessories

	Model	Size	Finish	BHMA	EDP #	Stock Item	List Price	UOM	Order Multiple	Box Qty	Carton Qty	MPG	
	<b>CB1900R NRP</b> Steel Full Mortise Std Weight Hinge, Non Removable Pin	4"x4"	26D	652	711940126		60.49	Ea.	1Ea.	3 Ea.	48 Ea.	EO	
			3	632	711940127		74.92	Ea.	1Ea.	3 Ea.	48 Ea.	EO	
		4.5"x4"	P	600	711940128		59.54	Ea.	1Ea.	3 Ea.	48 Ea.	EO	
			4	633	711940129		58.56	Ea.	1Ea.	3 Ea.	48 Ea.	EO	
			15	646	711940130		68.16	Ea.	1Ea.	3 Ea.	48 Ea.	EO	
			10	639	711940131		62.42	Ea.	1Ea.	3 Ea.	48 Ea.	EO	
			26D	652	711940132	✓	62.42	Ea.	1Ea.	3 Ea.	48 Ea.	EO	
			10A	641	711940133		72.99	Ea.	1Ea.	3 Ea.	48 Ea.	EO	
			26	651	711940134		72.99	Ea.	1Ea.	3 Ea.	48 Ea.	EO	
			3	632	711940135		80.69	Ea.	1Ea.	3 Ea.	48 Ea.	EO	
			4.5"x4.5"	P	600	711940136		54.72	Ea.	1Ea.	3 Ea.	48 Ea.	EO
				4	633	711940137		58.56	Ea.	1Ea.	3 Ea.	48 Ea.	EO
		10		639	711940138		62.42	Ea.	1Ea.	3 Ea.	48 Ea.	EO	
		26D		652	711940139	✓	62.42	Ea.	1Ea.	3 Ea.	48 Ea.	EO	
		10B		640	711940140		82.59	Ea.	1Ea.	3 Ea.	48 Ea.	EO	
		26		651	711940141		72.99	Ea.	1Ea.	3 Ea.	48 Ea.	EO	
		10A		641	711940142		82.59	Ea.	1Ea.	3 Ea.	48 Ea.	EO	
		3		632	711940143		80.69	Ea.	1Ea.	3 Ea.	48 Ea.	EO	
		15		646	711940144		84.53	Ea.	1Ea.	3 Ea.	48 Ea.	EO	
		5"x4.5"		26D	652	711940145		90.31	Ea.	1Ea.	3 Ea.	30 Ea.	EO
			26	651	711940146		119.16	Ea.	1Ea.	3 Ea.	30 Ea.	EO	
			P	600	711940147		90.31	Ea.	1Ea.	3 Ea.	30 Ea.	EO	
		5"x5"	26D	652	711940148		90.31	Ea.	1Ea.	3 Ea.	30 Ea.	EO	
			10A	641	711940149		119.16	Ea.	1Ea.	3 Ea.	30 Ea.	EO	
26	651		711940150		119.16	Ea.	1Ea.	3 Ea.	30 Ea.	EO			
	<b>CBK1900R</b> Steel Full Mortise Std Weight Hinge Rust Resistant Base	4.5"x4.5"	P	600	711940151		68.81	Ea.	1Ea.	3 Ea.	48 Ea.	EO	
	<b>CBK1900R NRP</b> Steel Full Mortise Std Weight Hinge Rust Resistant Base, Non Removable Pin	4.5"x4.5"	P	600	711940152		77.39	Ea.	1Ea.	3 Ea.	48 Ea.	EO	
	<b>HTCB1900R</b> Steel Full Mortise Std Weight Hinge Hospital Tips	4.5"x4"	26D	652	711940153		92.74	Ea.	1Ea.	3 Ea.	48 Ea.	EO	
		4.5"x4.5"	26D	652	711940154		92.74	Ea.	1Ea.	3 Ea.	48 Ea.	EO	
	<b>CECB1900R-54-LH</b> Steel Full Mortise Std Weight Hinge Concealed Conductor 4- wire	4.5"x4"	26D	652	711940240		467.03	Ea.	1Ea.	1Ea.	5 Ea.	D4	
			P	600	711940241		464.15	Ea.	1Ea.	1Ea.	5 Ea.	D4	
			3	632	711940242		485.30	Ea.	1Ea.	1Ea.	5 Ea.	D4	
			26	651	711940243		477.60	Ea.	1Ea.	1Ea.	5 Ea.	D4	
			10A	641	711940244		477.60	Ea.	1Ea.	1Ea.	5 Ea.	D4	
			4	633	711940245		463.18	Ea.	1Ea.	1Ea.	5 Ea.	D4	
			10	639	711940246		467.03	Ea.	1Ea.	1Ea.	5 Ea.	D4	
		4.5"x4.5"	26D	652	711940247		467.03	Ea.	1Ea.	1Ea.	5 Ea.	D4	
			P	600	711940248		459.33	Ea.	1Ea.	1Ea.	5 Ea.	D4	
			3	632	711940249		485.30	Ea.	1Ea.	1Ea.	5 Ea.	D4	
			26	651	711940250		477.60	Ea.	1Ea.	1Ea.	5 Ea.	D4	
			10A	641	711940251		487.20	Ea.	1Ea.	1Ea.	5 Ea.	D4	
			4	633	711940252		463.18	Ea.	1Ea.	1Ea.	5 Ea.	D4	
	10	639	711940253		467.03	Ea.	1Ea.	1Ea.	5 Ea.	D4			

# Three Knuckle Concealed Bearing Architectural Hinges (cont.) Hinges & Door Accessories

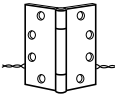
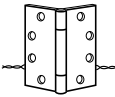
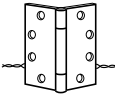
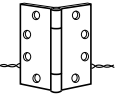
	Model	Size	Finish	BHMA	EDP #	Stock Item	List Price	UOM	Order Multiple	Box Qty	Carton Qty	MPG
	<b>CECB1900R-54-RH</b> Steel Full Mortise Std Weight Hinge Concealed Conductor 4- wire	4.5"x4"	26D	652	711940296		467.03	Ea.	1Ea	1Ea	5Ea	D4
			P	600	711940297		464.15	Ea.	1Ea	1Ea	5Ea	D4
			3	632	711940298		485.30	Ea.	1Ea	1Ea	5Ea	D4
			26	651	711940299		477.60	Ea.	1Ea	1Ea	5Ea	D4
			10A	641	711940300		477.60	Ea.	1Ea	1Ea	5Ea	D4
			4	633	711940301		463.18	Ea.	1Ea	1Ea	5Ea	D4
		10	639	711940302		463.18	Ea.	1Ea	1Ea	5Ea	D4	
		4.5"x4.5"	P	600	711940304		459.33	Ea.	1Ea	1Ea	5Ea	D4
			3	632	711940305		485.30	Ea.	1Ea	1Ea	5Ea	D4
			26	651	711940306		477.60	Ea.	1Ea	1Ea	5Ea	D4
			10A	641	711940307		487.20	Ea.	1Ea	1Ea	5Ea	D4
			4	633	711940308		463.18	Ea.	1Ea	1Ea	5Ea	D4
			26D	652	711940303	✓	467.03	Ea.	1Ea	1Ea	5Ea	D4
			10	639	711940309		467.03	Ea.	1Ea	1Ea	5Ea	D4
	<b>CECB1900R-56-LH</b> Steel Full Mortise Std Weight Hinge Concealed Conductor 6- wire		4.5"x4"	26D	652	711940254		573.46	Ea.	1Ea	1Ea	5Ea
		P		600	711940255		570.58	Ea.	1Ea	1Ea	5Ea	D4
		3		632	711940256		591.73	Ea.	1Ea	1Ea	5Ea	D4
		26		651	711940257		584.03	Ea.	1Ea	1Ea	5Ea	D4
		10A		641	711940258		584.03	Ea.	1Ea	1Ea	5Ea	D4
		4		633	711940259		569.61	Ea.	1Ea	1Ea	5Ea	D4
		10	639	711940260		573.46	Ea.	1Ea	1Ea	5Ea	D4	
		4.5"x4.5"	26D	652	711940261		573.46	Ea.	1Ea	1Ea	5Ea	D4
			P	600	711940262		565.76	Ea.	1Ea	1Ea	5Ea	D4
			3	632	711940263		591.73	Ea.	1Ea	1Ea	5Ea	D4
			26	651	711940264		584.03	Ea.	1Ea	1Ea	5Ea	D4
			10A	641	711940265		593.63	Ea.	1Ea	1Ea	5Ea	D4
			4	633	711940266		569.61	Ea.	1Ea	1Ea	5Ea	D4
			10	639	711940267		573.46	Ea.	1Ea	1Ea	5Ea	D4
	<b>CECB1900R-56-RH</b> Steel Full Mortise Std Weight Hinge Concealed Conductor 6- wire		4.5"x4"	26D	652	711940310		573.46	Ea.	1Ea	1Ea	5Ea
		P		600	711940311		570.58	Ea.	1Ea	1Ea	5Ea	D4
		3		632	711940312		591.73	Ea.	1Ea	1Ea	5Ea	D4
		26		651	711940313		584.03	Ea.	1Ea	1Ea	5Ea	D4
		10A		641	711940314		584.03	Ea.	1Ea	1Ea	5Ea	D4
		4		633	711940315		569.61	Ea.	1Ea	1Ea	5Ea	D4
		10	639	711940316		573.46	Ea.	1Ea	1Ea	5Ea	D4	
		4.5"x4.5"	26D	652	711940317		573.46	Ea.	1Ea	1Ea	5Ea	D4
			P	600	711940318		565.76	Ea.	1Ea	1Ea	5Ea	D4
			3	632	711940319		591.73	Ea.	1Ea	1Ea	5Ea	D4
			26	651	711940320		584.03	Ea.	1Ea	1Ea	5Ea	D4
			10A	641	711940321		593.63	Ea.	1Ea	1Ea	5Ea	D4
			4	633	711940322		569.61	Ea.	1Ea	1Ea	5Ea	D4
			10	639	711940323		573.46	Ea.	1Ea	1Ea	5Ea	D4
	<b>CECB1900R-58-LH</b> Steel Full Mortise Std Weight Hinge Concealed Conductor 8- wire		4.5"x4"	26D	652	711940268		604.76	Ea.	1Ea	1Ea	5Ea
		P		600	711940269		601.88	Ea.	1Ea	1Ea	5Ea	D4
		3		632	711940270		623.04	Ea.	1Ea	1Ea	5Ea	D4
		26		651	711940271		615.34	Ea.	1Ea	1Ea	5Ea	D4
		10A		641	711940272		615.34	Ea.	1Ea	1Ea	5Ea	D4
		4		633	711940273		600.91	Ea.	1Ea	1Ea	5Ea	D4
		10	639	711940274		604.76	Ea.	1Ea	1Ea	5Ea	D4	
		4.5"x4.5"	26D	652	711940275		604.76	Ea.	1Ea	1Ea	5Ea	D4
			P	600	711940276		597.07	Ea.	1Ea	1Ea	5Ea	D4
			3	632	711940277		623.04	Ea.	1Ea	1Ea	5Ea	D4
			26	651	711940278		615.34	Ea.	1Ea	1Ea	5Ea	D4
			10A	641	711940279		624.94	Ea.	1Ea	1Ea	5Ea	D4
			4	633	711940280		600.91	Ea.	1Ea	1Ea	5Ea	D4
			10	639	711940281		604.76	Ea.	1Ea	1Ea	5Ea	D4

All prices are for items furnished with screws (as specified in catalog) unless otherwise stated in price list.  
 \* To price other finishes on architectural items – See pricing extras.

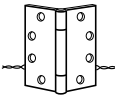
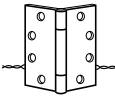

\*\* For conversion pins and decorative tips – See Miscellaneous Architectural Parts.  
 (X) Item must be ordered in these increments.

# Three Knuckle Concealed Bearing Architectural Hinges (cont.) Hinges & Door Accessories

Model	Size	Finish	BHMA	EDP #	Stock Item	List Price	UOM	Order Multiple	Box Qty	Carton Qty	MPG
 <b>CECB1900R-58-RH</b> Steel Full Mortise Std Weight Hinge Concealed Conductor 8- wire	4.5"x4"	26D	652	711940324		604.76	Ea.	1Ea	1Ea	5 Ea.	D4
		P	600	711940325		601.88	Ea.	1Ea	1Ea	5 Ea.	D4
		3	632	711940326		623.04	Ea.	1Ea	1Ea	5 Ea.	D4
		26	651	711940327		623.04	Ea.	1Ea	1Ea	5 Ea.	D4
		10A	641	711940328		615.34	Ea.	1Ea	1Ea	5 Ea.	D4
		4	633	711940329		600.91	Ea.	1Ea	1Ea	5 Ea.	D4
	4.5"x4.5"	10	639	711940330		604.76	Ea.	1Ea	1Ea	5 Ea.	D4
		26D	652	711940331		604.76	Ea.	1Ea	1Ea	5 Ea.	D4
		P	600	711940332		597.07	Ea.	1Ea	1Ea	5 Ea.	D4
		3	632	711940333		623.04	Ea.	1Ea	1Ea	5 Ea.	D4
		26	651	711940334		615.34	Ea.	1Ea	1Ea	5 Ea.	D4
		10A	641	711940335		624.94	Ea.	1Ea	1Ea	5 Ea.	D4
		4	633	711940336		600.91	Ea.	1Ea	1Ea	5 Ea.	D4
		10	639	711940337		604.76	Ea.	1Ea	1Ea	5 Ea.	D4
		<b>CECB1900R-66-LH</b> Steel Full Mortise Std Weight Hinge Concealed Conductor Spec. 6- wire	4.5"x4"	26D	652	711940282		592.24	Ea.	1Ea	1Ea
P	600			711940283		589.36	Ea.	1Ea	1Ea	5 Ea.	D4
3	632			711940284		610.51	Ea.	1Ea	1Ea	5 Ea.	D4
26	651			711940285		602.81	Ea.	1Ea	1Ea	5 Ea.	D4
10A	641			711940286		602.81	Ea.	1Ea	1Ea	5 Ea.	D4
4	633			711940287		588.39	Ea.	1Ea	1Ea	5 Ea.	D4
4.5"x4.5"	10		639	711940288		592.24	Ea.	1Ea	1Ea	5 Ea.	D4
	26D		652	711940289		592.24	Ea.	1Ea	1Ea	5 Ea.	D4
	P		600	711940290		584.54	Ea.	1Ea	1Ea	5 Ea.	D4
	3		632	711940291		610.51	Ea.	1Ea	1Ea	5 Ea.	D4
	26		651	711940292		602.81	Ea.	1Ea	1Ea	5 Ea.	D4
	10A		641	711940293		612.41	Ea.	1Ea	1Ea	5 Ea.	D4
	4		633	711940294	✓	588.39	Ea.	1Ea	1Ea	5 Ea.	D4
	10		639	711940295		592.24	Ea.	1Ea	1Ea	5 Ea.	D4
	 <b>CECB1900R-66-RH</b> Steel Full Mortise Std Weight Hinge Concealed Conductor Spec. 6- wire		4.5"x4"	26D	652	711940338		592.24	Ea.	1Ea	1Ea
P		600		711940339		589.36	Ea.	1Ea	1Ea	5 Ea.	D4
3		632		711940340		610.51	Ea.	1Ea	1Ea	5 Ea.	D4
26		651		711940341		602.81	Ea.	1Ea	1Ea	5 Ea.	D4
10A		641		711940342		602.81	Ea.	1Ea	1Ea	5 Ea.	D4
4		633		711940343		588.39	Ea.	1Ea	1Ea	5 Ea.	D4
4.5"x4.5"		10	639	711940344		592.24	Ea.	1Ea	1Ea	5 Ea.	D4
		26D	652	711940345		592.24	Ea.	1Ea	1Ea	5 Ea.	D4
		P	600	711940346		584.54	Ea.	1Ea	1Ea	5 Ea.	D4
		3	632	711940347		610.51	Ea.	1Ea	1Ea	5 Ea.	D4
		26	651	711940348		602.81	Ea.	1Ea	1Ea	5 Ea.	D4
		10A	641	711940349		612.41	Ea.	1Ea	1Ea	5 Ea.	D4
		4	633	711940350		588.39	Ea.	1Ea	1Ea	5 Ea.	D4
		10	639	711940351		592.24	Ea.	1Ea	1Ea	5 Ea.	D4

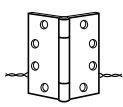

# Three Knuckle Concealed Bearing Architectural Hinges (cont.) Hinges & Door Accessories

Model	Size	Finish	BHMA	EDP #	Stock Item	List Price	UOM	Order Multiple	Box Qty	Carton Qty	MPG	
 <b>CB1901R</b> Steel Full Mortise Hvy Weight Hinge	4.5"x4"	26D	652	711950001	✓	139.44	Ea.	1Ea	3 Ea	30 Ea.	EO	
		15	646	711950002		146.15	Ea.	1Ea	3 Ea	30 Ea.	EO	
		10	639	711950003		129.82	Ea.	1Ea	3 Ea	30 Ea.	EO	
		26	651	711950004		158.68	Ea.	1Ea	3 Ea	30 Ea.	EO	
		10A	641	711950005		158.68	Ea.	1Ea	3 Ea	30 Ea.	EO	
		3	632	711950006		158.68	Ea.	1Ea	3 Ea	30 Ea.	EO	
	4.5"x4.5"	10B	640	711950007	✓	158.68	Ea.	1Ea	3 Ea	30 Ea.	EO	
		P	600	711950008		125.01	Ea.	1Ea	3 Ea	30 Ea.	EO	
		10	639	711950009		129.82	Ea.	1Ea	3 Ea	30 Ea.	EO	
		26D	652	711950010	✓	139.44	Ea.	1Ea	3 Ea	30 Ea.	EO	
		26	651	711950011		158.68	Ea.	1Ea	3 Ea	30 Ea.	EO	
		10A	641	711950012		158.68	Ea.	1Ea	3 Ea	30 Ea.	EO	
	5"x4.5"	3	632	711950013		158.68	Ea.	1Ea	3 Ea	30 Ea.	EO	
		15	646	711950014		146.15	Ea.	1Ea	3 Ea	30 Ea.	EO	
		P	600	711950015		145.21	Ea.	1Ea	3 Ea	24 Ea.	EO	
		10	639	711950016		149.04	Ea.	1Ea	3 Ea	24 Ea.	EO	
		26D	652	711950017	✓	153.86	Ea.	1Ea	3 Ea	24 Ea.	EO	
		10A	641	711950018		180.78	Ea.	1Ea	3 Ea	24 Ea.	EO	
	5"x5"	26	651	711950019		185.61	Ea.	1Ea	3 Ea	24 Ea.	EO	
		P	600	711950020		145.21	Ea.	1Ea	3 Ea	24 Ea.	EO	
		26D	652	711950021		153.86	Ea.	1Ea	3 Ea	24 Ea.	EO	
		10	639	711950022		153.86	Ea.	1Ea	3 Ea	24 Ea.	EO	
	6"x5"	10A	641	711950023		186.55	Ea.	1Ea	3 Ea	24 Ea.	EO	
		26D	652	711950024		245.25	Ea.	1Ea	3 Ea	24 Ea.	EO	
6"x6"		26D	652		275.83	Ea.	1Ea	3 Ea	24 Ea.	EO		
 <b>CB1901R NRP</b> Steel Full Mortise Hvy Weight Hinge, Non Removable Pin	4.5"x4"	26D	652	711950025	✓	148.02	Ea.	1Ea	3 Ea	30 Ea.	EO	
		15	646	711950026		154.73	Ea.	1Ea	3 Ea	30 Ea.	EO	
		10	639	711950027		138.40	Ea.	1Ea	3 Ea	30 Ea.	EO	
		10A	641	711950028		167.26	Ea.	1Ea	3 Ea	30 Ea.	EO	
		10B	640	711950029		167.26	Ea.	1Ea	3 Ea	30 Ea.	EO	
		26	651	711950030		167.26	Ea.	1Ea	3 Ea	30 Ea.	EO	
	4.5"x4.5"	3	632	711950031		167.26	Ea.	1Ea	3 Ea	30 Ea.	EO	
		P	600	711950032		133.59	Ea.	1Ea	3 Ea	30 Ea.	EO	
		10	639	711950033		138.40	Ea.	1Ea	3 Ea	30 Ea.	EO	
		26D	652	711950034	✓	148.02	Ea.	1Ea	3 Ea	30 Ea.	EO	
		10A	641	711950035		167.26	Ea.	1Ea	3 Ea	30 Ea.	EO	
		26	651	711950036		167.26	Ea.	1Ea	3 Ea	30 Ea.	EO	
	5"x4.5"	3	632	711950037		167.26	Ea.	1Ea	3 Ea	30 Ea.	EO	
		15	646	711950038		154.73	Ea.	1Ea	3 Ea	30 Ea.	EO	
		P	600	711950039		153.79	Ea.	1Ea	3 Ea	24 Ea.	EO	
		26D	652	711950040	✓	162.44	Ea.	1Ea	3 Ea	24 Ea.	EO	
		5"x5"	26D	652	711950043		162.44	Ea.	1Ea	3 Ea	24 Ea.	EO
			10	639	711950044		162.44	Ea.	1Ea	3 Ea	24 Ea.	EO
	10A		641	711950045		195.13	Ea.	1Ea	3 Ea	24 Ea.	EO	
	 <b>CECB1901R-54-LH</b> Steel Full Mortise Hvy Weight Hinge Concealed Conductor 4- wire	4.5"x4"	P	600	711950046		153.79	Ea.	1Ea	3 Ea	24 Ea.	EO
			26D	652	711950166		552.63	Ea.	1Ea	1Ea	5 Ea.	D4
			P	600	711950167		538.20	Ea.	1Ea	1Ea	5 Ea.	D4
			10	639	711950168		543.02	Ea.	1Ea	1Ea	5 Ea.	D4
			10A	641	711950169		571.87	Ea.	1Ea	1Ea	5 Ea.	D4
3			632	711950170		571.87	Ea.	1Ea	1Ea	5 Ea.	D4	
4.5"x4.5"		10B	640	711950171		571.87	Ea.	1Ea	1Ea	5 Ea.	D4	
		26	651	711950172		571.87	Ea.	1Ea	1Ea	5 Ea.	D4	
		26D	652	711950173		552.63	Ea.	1Ea	1Ea	5 Ea.	D4	
		P	600	711950174		538.20	Ea.	1Ea	1Ea	5 Ea.	D4	
		10	639	711950175		543.02	Ea.	1Ea	1Ea	5 Ea.	D4	
		10A	641	711950176		571.87	Ea.	1Ea	1Ea	5 Ea.	D4	
		3	632	711950177		571.87	Ea.	1Ea	1Ea	5 Ea.	D4	
		10B	640	711950178		571.87	Ea.	1Ea	1Ea	5 Ea.	D4	
		26	651	711950179		571.87	Ea.	1Ea	1Ea	5 Ea.	D4	



All prices are for items furnished with screws (as specified in catalog) unless otherwise stated in price list.  
 \* To price other finishes on architectural items – See pricing extras.

\*\* For conversion pins and decorative tips – See Miscellaneous Architectural Parts.  
 (X) Item must be ordered in these increments.

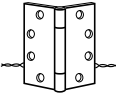
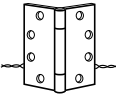
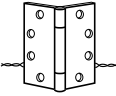
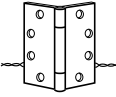



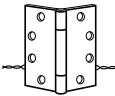
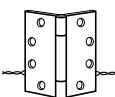
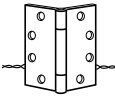

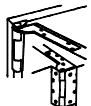
# Three Knuckle Concealed Bearing Architectural Hinges (cont.) Hinges & Door Accessories

	Model	Size	Finish	BHMA	EDP #	Stock Item	List Price	UOM	Order Multiple	Box Qty	Carton Qty	MPG	
	<b>CECB1901R-54-RH</b> Steel Full Mortise Hvy Weight Hinge Concealed Conductor 4- wire	4.5"x4"	26D	652	711950222		552.63	Ea.	1Ea	1Ea	5 Ea.	D4	
			P	600	711950223		538.20	Ea.	1Ea	1Ea	5 Ea.	D4	
			10	639	711950224		543.02	Ea.	1Ea	1Ea	5 Ea.	D4	
			10A	641	711950225		571.87	Ea.	1Ea	1Ea	5 Ea.	D4	
			3	632	711950226		571.87	Ea.	1Ea	1Ea	5 Ea.	D4	
			10B	640	711950227		571.87	Ea.	1Ea	1Ea	5 Ea.	D4	
		4.5"x4.5"	26D	652	711950228		571.87	Ea.	1Ea	1Ea	1Ea	5 Ea.	D4
			P	600	711950229		552.63	Ea.	1Ea	1Ea	1Ea	5 Ea.	D4
			10	639	711950230		538.20	Ea.	1Ea	1Ea	1Ea	5 Ea.	D4
			10A	641	711950231		543.02	Ea.	1Ea	1Ea	1Ea	5 Ea.	D4
			3	632	711950232		571.87	Ea.	1Ea	1Ea	1Ea	5 Ea.	D4
			10B	640	711950233		571.87	Ea.	1Ea	1Ea	1Ea	5 Ea.	D4
			10B	640	711950234		571.87	Ea.	1Ea	1Ea	1Ea	5 Ea.	D4
			26	651	711950235		571.87	Ea.	1Ea	1Ea	1Ea	5 Ea.	D4
	<b>CECB1901R-56-LH</b> Steel Full Mortise Hvy Weight Hinge Concealed Conductor 6- wire	4.5"x4"	26D	652	711950180		659.06	Ea.	1Ea	1Ea	5 Ea.	D4	
			P	600	711950181		644.63	Ea.	1Ea	1Ea	5 Ea.	D4	
			10	639	711950182		649.44	Ea.	1Ea	1Ea	5 Ea.	D4	
			10A	641	711950183		678.30	Ea.	1Ea	1Ea	5 Ea.	D4	
			3	632	711950184		678.30	Ea.	1Ea	1Ea	5 Ea.	D4	
			10B	640	711950185		678.30	Ea.	1Ea	1Ea	5 Ea.	D4	
		4.5"x4.5"	26D	652	711950186		678.30	Ea.	1Ea	1Ea	1Ea	5 Ea.	D4
			P	600	711950187		673.49	Ea.	1Ea	1Ea	1Ea	5 Ea.	D4
			10	639	711950188		644.63	Ea.	1Ea	1Ea	1Ea	5 Ea.	D4
			10A	641	711950189		649.44	Ea.	1Ea	1Ea	1Ea	5 Ea.	D4
			10A	641	711950190		678.30	Ea.	1Ea	1Ea	1Ea	5 Ea.	D4
			3	632	711950191		678.30	Ea.	1Ea	1Ea	1Ea	5 Ea.	D4
			10B	640	711950192		678.30	Ea.	1Ea	1Ea	1Ea	5 Ea.	D4
			26	651	711950193		678.30	Ea.	1Ea	1Ea	1Ea	5 Ea.	D4
	<b>CECB1901R-56-RH</b> Steel Full Mortise Hvy Weight Hinge Concealed Conductor 6- wire	4.5"x4"	26D	652	711950236		659.06	Ea.	1Ea	1Ea	5 Ea.	D4	
			P	600	711950237		644.63	Ea.	1Ea	1Ea	5 Ea.	D4	
			10	639	711950238		649.44	Ea.	1Ea	1Ea	5 Ea.	D4	
			10A	641	711950239		678.30	Ea.	1Ea	1Ea	5 Ea.	D4	
			3	632	711950240		678.30	Ea.	1Ea	1Ea	5 Ea.	D4	
			10B	640	711950241		678.30	Ea.	1Ea	1Ea	5 Ea.	D4	
		4.5"x4.5"	26	651	711950242		678.30	Ea.	1Ea	1Ea	1Ea	5 Ea.	D4
			26D	652	711950243		659.06	Ea.	1Ea	1Ea	1Ea	5 Ea.	D4
			P	600	711950244		644.63	Ea.	1Ea	1Ea	1Ea	5 Ea.	D4
			10	639	711950245		649.44	Ea.	1Ea	1Ea	1Ea	5 Ea.	D4
			10A	641	711950246		678.30	Ea.	1Ea	1Ea	1Ea	5 Ea.	D4
			3	632	711950247		678.30	Ea.	1Ea	1Ea	1Ea	5 Ea.	D4
			10B	640	711950248		678.30	Ea.	1Ea	1Ea	1Ea	5 Ea.	D4
			26	651	711950249		678.30	Ea.	1Ea	1Ea	1Ea	5 Ea.	D4
	<b>CECB1901R-58-LH</b> Steel Full Mortise Hvy Weight Hinge Concealed Conductor 8- wire	4.5"x4"	26D	652	711950194		690.36	Ea.	1Ea	1Ea	5 Ea.	D4	
			P	600	711950195		675.93	Ea.	1Ea	1Ea	5 Ea.	D4	
			10	639	711950196		680.75	Ea.	1Ea	1Ea	5 Ea.	D4	
			10A	641	711950197		709.60	Ea.	1Ea	1Ea	5 Ea.	D4	
			3	632	711950198		709.60	Ea.	1Ea	1Ea	5 Ea.	D4	
			10B	640	711950199		709.60	Ea.	1Ea	1Ea	5 Ea.	D4	
		4.5"x4.5"	26	651	711950200		709.60	Ea.	1Ea	1Ea	1Ea	5 Ea.	D4
			26D	652	711950201		690.36	Ea.	1Ea	1Ea	1Ea	5 Ea.	D4
			P	600	711950202		675.93	Ea.	1Ea	1Ea	1Ea	5 Ea.	D4
			10	639	711950203		680.75	Ea.	1Ea	1Ea	1Ea	5 Ea.	D4
			10A	641	711950204		709.60	Ea.	1Ea	1Ea	1Ea	5 Ea.	D4
			3	632	711950205		709.60	Ea.	1Ea	1Ea	1Ea	5 Ea.	D4
			10B	640	711950206		709.60	Ea.	1Ea	1Ea	1Ea	5 Ea.	D4
			26	651	711950207		709.60	Ea.	1Ea	1Ea	1Ea	5 Ea.	D4

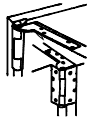
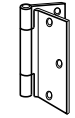
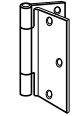
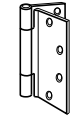
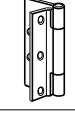
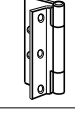
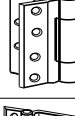
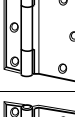
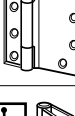

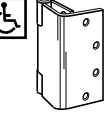

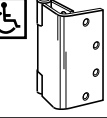

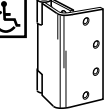



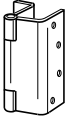

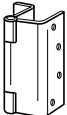
# Three Knuckle Concealed Bearing Architectural Hinges (cont.) Hinges & Door Accessories

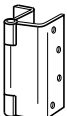
	Model	Size	Finish	BHMA	EDP #	Stock Item	List Price	UOM	Order Multiple	Box Qty	Carton Qty	MPG												
	<b>CECB1901R-58-RH</b> Steel Full Mortise Hvy Weight Hinge Concealed Conductor 8- wire	4.5"x4"	26D	652	71950250		690.36	Ea.	1Ea	1Ea	5 Ea.	D4												
			P	600	71950251		675.93	Ea.	1Ea	1Ea	5 Ea.	D4												
			10	639	71950252		680.75	Ea.	1Ea	1Ea	5 Ea.	D4												
			10A	641	71950253		709.60	Ea.	1Ea	1Ea	5 Ea.	D4												
			3	632	71950254		709.60	Ea.	1Ea	1Ea	5 Ea.	D4												
			10B	640	71950255		709.60	Ea.	1Ea	1Ea	5 Ea.	D4												
		4.5"x4.5"																						
															26D	652	71950257		690.36	Ea.	1Ea	1Ea	5 Ea.	D4
															P	600	71950258		675.93	Ea.	1Ea	1Ea	5 Ea.	D4
															10	639	71950259		680.75	Ea.	1Ea	1Ea	5 Ea.	D4
															10A	641	71950260		709.60	Ea.	1Ea	1Ea	5 Ea.	D4
															3	632	71950261		709.60	Ea.	1Ea	1Ea	5 Ea.	D4
															10B	640	71950262		709.60	Ea.	1Ea	1Ea	5 Ea.	D4
															26	651	71950263		709.60	Ea.	1Ea	1Ea	5 Ea.	D4
	<b>CECB1901R-66-LH</b> Steel Full Mortise Hvy Weight Hinge Concealed Conductor Spec. 6- wire	4.5"x4"	26D	652	71950208		677.84	Ea.	1Ea	1Ea	5 Ea.	D4												
			P	600	71950209		663.41	Ea.	1Ea	1Ea	5 Ea.	D4												
			10	639	71950210		668.23	Ea.	1Ea	1Ea	5 Ea.	D4												
			10A	641	71950211		697.08	Ea.	1Ea	1Ea	5 Ea.	D4												
			3	632	71950212		697.08	Ea.	1Ea	1Ea	5 Ea.	D4												
			10B	640	71950213		697.08	Ea.	1Ea	1Ea	5 Ea.	D4												
		4.5"x4.5"																						
															26D	652	71950215		677.84	Ea.	1Ea	1Ea	5 Ea.	D4
															P	600	71950216		663.41	Ea.	1Ea	1Ea	5 Ea.	D4
															10	639	71950217		668.23	Ea.	1Ea	1Ea	5 Ea.	D4
															10A	641	71950218		697.08	Ea.	1Ea	1Ea	5 Ea.	D4
															3	632	71950219		697.08	Ea.	1Ea	1Ea	5 Ea.	D4
															10B	640	71950220		697.08	Ea.	1Ea	1Ea	5 Ea.	D4
															26	651	71950221		697.08	Ea.	1Ea	1Ea	5 Ea.	D4
	<b>CECB1901R-66-RH</b> Steel Full Mortise Hvy Weight Hinge Concealed Conductor Spec. 6- wire	4.5"x4"	26D	652	71950264		677.84	Ea.	1Ea	1Ea	5 Ea.	D4												
			P	600	71950265		663.41	Ea.	1Ea	1Ea	5 Ea.	D4												
			10	639	71950266		668.23	Ea.	1Ea	1Ea	5 Ea.	D4												
			10A	641	71950267		697.08	Ea.	1Ea	1Ea	5 Ea.	D4												
			3	632	71950268		697.08	Ea.	1Ea	1Ea	5 Ea.	D4												
			10B	640	71950269		697.08	Ea.	1Ea	1Ea	5 Ea.	D4												
		4.5"x4.5"																						
															26D	652	71950271		677.84	Ea.	1Ea	1Ea	5 Ea.	D4
															P	600	71950272		668.23	Ea.	1Ea	1Ea	5 Ea.	D4
															10	639	71950273		668.23	Ea.	1Ea	1Ea	5 Ea.	D4
															10A	641	71950274		697.08	Ea.	1Ea	1Ea	5 Ea.	D4
															3	632	71950275		697.08	Ea.	1Ea	1Ea	5 Ea.	D4
															10B	640	71950276		697.08	Ea.	1Ea	1Ea	5 Ea.	D4
															26	651	71950277		697.08	Ea.	1Ea	1Ea	5 Ea.	D4
	<b>IHTCB1901R</b> Steel Institutional Full Mortise Hvy Weight Hinge	4.5"x4.5"	P	600	71950047		204.85	Ea.	1Ea	3 Ea.	30 Ea.	E0												
		5"x4.5"	P	600	71950049		266.40	Ea.	1Ea	3 Ea.	24 Ea.	E0												
	<b>CB1907R LH</b> Steel Pivot-Reinforced Heavy Weight Hinge for Square or Beveled Edge Doors	5"x4.5"	26D	652	71950050		767.42	Set	1Set	1Set	1Set	E0												
			P	600			669.31	Set	1Set	1Set	1Set	E0												
Must be ordered as a complete set.	<b>CB1907R RH</b> Steel Pivot-Reinforced Heavy Weight Hinge for Square or Beveled Edge Doors	5"x4.5"	26D	652	71950051		767.42	Set	1Set	1Set	1Set	E0												
			P	600			669.31	Set	1Set	1Set	1Set	E0												
	<b>CB1908R LH</b> Steel Pivot-Reinforced Heavy Weight Hinge for Square Edge Doors	5"x4.5"	P	600	71950052		669.31	Set	1Set	1Set	1Set	E0												
			26D	652	71950053		767.42	Set	1Set	1Set	1Set	E0												
Must be ordered as a complete set.	<b>CB1908R RH</b> Steel Pivot-Reinforced Heavy Weight Hinge for Square Edge Doors	5"x4.5"	P	600	71950054		669.31	Set	1Set	1Set	1Set	E0												
			26D	652	71950055		767.42	Set	1Set	1Set	1Set	E0												

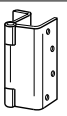
# Three Knuckle Concealed Bearing Architectural Hinges (cont.) Hinges & Door Accessories

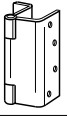
	Model	Size	Finish	BHMA	EDP #	Stock Item	List Price	UOM	Order Multiple	Box Qty	Carton Qty	MPG
 <p>Must be ordered as a complete set.</p>	<b>CB1909R LH</b>	5"x4.5"	P	600	71950056		692.40	Set	1 Set	1 Set	1 Set	EO
			26D	652	71950057		755.88	Set	1 Set	1 Set	1 Set	EO
	<b>CB1909R RH</b>	5"x4.5"	P	600	71950058		692.40	Set	1 Set	1 Set	1 Set	EO
			26D	652	71950059		755.88	Set	1 Set	1 Set	1 Set	EO
	<b>1910R</b>	4.5"	P	600	71940047		61.53	Ea.	1 Ea.	3 Ea.	30 Ea.	EO
			26D	652	71940048		80.77	Ea.	1 Ea.	3 Ea.	30 Ea.	EO
	<b>CB1910R</b>	4"	P	600	71940157		88.44	Ea.	1 Ea.	3 Ea.	48 Ea.	EO
		4.5"	P	600	71940158		108.64	Ea.	1 Ea.	3 Ea.	30 Ea.	EO
			26D	652	71940159		130.78	Ea.	1 Ea.	3 Ea.	30 Ea.	EO
		5"	26D	652	71940160		194.26	Ea.	1 Ea.	3 Ea.	24 Ea.	EO
	<b>CB1911R</b>	4.5"	26D	652	71950062		257.74	Ea.	1 Ea.	3 Ea.	30 Ea.	EO
		5"	26D	652	71950063		293.31	Ea.	1 Ea.	3 Ea.	24 Ea.	EO
		6"	P	600	71950064		315.46	Ea.	1 Ea.	3 Ea.	15 Ea.	EO
	<b>1920R</b>	4.5"	P	652	71940049		113.47	Ea.	1 Ea.	3 Ea.	30 Ea.	EO
	<b>CB1920R</b>	4.5"	P	600	71940161		110.80	Ea.	1 Ea.	3 Ea.	30 Ea.	EO
			26D	652	71940162		130.78	Ea.	1 Ea.	3 Ea.	30 Ea.	EO
		5"	P	600	71940163		162.52	Ea.	1 Ea.	3 Ea.	24 Ea.	EO
	<b>CB1921R</b>	4.5"	P	600	71950065		235.60	Ea.	1 Ea.	3 Ea.	30 Ea.	EO
			26D	652	71950066		288.53	Ea.	1 Ea.	3 Ea.	30 Ea.	EO
		5"	P	600	71950067		301.97	Ea.	1 Ea.	3 Ea.	24 Ea.	EO
	<b>CB1930R</b>	4.5"	P	600	71940164		108.64	Ea.	1 Ea.	3 Ea.	30 Ea.	EO
		5"	26D	652	71940165		171.18	Ea.	1 Ea.	3 Ea.	24 Ea.	EO
	<b>CB1931R</b>	4.5"	P	600	71950069		235.60	Ea.	1 Ea.	3 Ea.	30 Ea.	EO
		5"	P	600	71950070		269.29	Ea.	1 Ea.	3 Ea.	24 Ea.	EO
		6"	P	600	71950071		359.68	Ea.	1 Ea.	3 Ea.	15 Ea.	EO
 	<b>CB1941R</b>	5"	26D	652	71950072		320.27	Ea.	1 Ea.	3 Ea.	15 Ea.	EO
 	<b>STSCB1941R</b>	5"	32D	630			332.77	Ea.	1 Ea.	3 Ea.	15 Ea.	EO
 	<b>CB1942R</b>	5"	P	600	71950073		317.38	Ea.	1 Ea.	3 Ea.	15 Ea.	EO

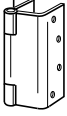

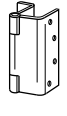

## Three Knuckle Concealed Bearing Architectural Hinges (cont.) Hinges & Door Accessories

	Model	Size	Finish	BHMA	EDP #	Stock Item	List Price	UOM	Order Multiple	Box Qty	Carton Qty	MPG
	 <b>STSCB1942R</b> Stainless Steel Half Mortise Swing-Clear Hvy Weight Hinge for 1/8" in 2" beveled edge doors	5"	32D	630			332.77	Ea.	1 Ea	3 Ea.	15 Ea.	EO
	 <b>CB1946R</b> Steel Full Mortise Swing-Clear Hvy Weight Hinge for 1/8" in 2" beveled edge doors	4.5"	26D	652	711940166		244.26	Ea.	1 Ea	3 Ea.	24 Ea.	EO
	 <b>STSCB1946R</b> Stainless Steel Full Mortise Swing-Clear Hvy Weight Hinge for 1/8" in 2" beveled edge doors	4.5"	32D	630			274.10	Ea.	1 Ea	3 Ea.	24 Ea.	EO
	 <b>CB1947R</b> Steel Full Mortise Swing-Clear Std Weight Hinge for Square Edge Doors	4.5"	26D	652	711940167		251.02	Ea.	1 Ea	3 Ea.	24 Ea.	EO
	<b>CB1947R NRP</b> Steel Full Mortise Swing-Clear Std Weight Hinge, Non Removable Pin for Square Edge Doors	4.5"	26D	652	711940168		259.60	Ea.	1 Ea	3 Ea.	24 Ea.	EO
	<b>STSCB1947R</b> Stainless Steel Full Mortise Swing-Clear Std Weight Hinge, Non Removable Pin for Square Edge Doors	4.5"	32D	630			251.02	Ea.	1 Ea	3 Ea.	24 Ea.	EO
	 <b>CB1948R</b> Steel Full Mortise Swing-Clear Hvy Weight Hinge for Square Edge Doors	5"	26D	652	711950074		317.38	Ea.	1 Ea	3 Ea.	15 Ea.	EO
			P	600	711950075		282.76	Ea.	1 Ea	3 Ea.	15 Ea.	EO
			10A	641	711950076		317.38	Ea.	1 Ea	3 Ea.	15 Ea.	EO
			10	639	711950077		317.38	Ea.	1 Ea	3 Ea.	15 Ea.	EO
	 <b>CB1948R NRP</b> Steel Full Mortise Swing-Clear Hvy Weight Hing, Non Removable Pin for Square Edge Doors	5"	26D	652	711950078		325.96	Ea.	1 Ea	3 Ea.	15 Ea.	EO
			10	639	711950079		325.96	Ea.	1 Ea	3 Ea.	15 Ea.	EO
			10A	641	711950080		325.96	Ea.	1 Ea	3 Ea.	15 Ea.	EO
	<b>STSCB1948R</b> Stainless Steel Full Mortise Swing-Clear Hvy Weight Hing, Non Removable Pin for Square Edge Doors	4.5"	32D	630		✓	353.91	Ea.	1 Ea	3 Ea.	15 Ea.	EO
		5"	32D	630			383.75	Ea.	1 Ea	3 Ea.	15 Ea.	EO
	 <b>CB1949R</b> Steel Full Mortise Swing-Clear Hvy Weight Hinge for 1/8" in 2" beveled edge doors	4.5"	26D	652	711950081		293.31	Ea.	1 Ea	3 Ea.	15 Ea.	EO
		5"	26D	652	711950082	✓	303.91	Ea.	1 Ea	3 Ea.	15 Ea.	EO
			10	639	711950083		293.31	Ea.	1 Ea	3 Ea.	15 Ea.	EO
	<b>CB1949R NRP</b> Steel Full Mortise Swing-Clear Hvy Weight Hinge, Non Removable Pin for 1/8" in 2" beveled edge doors	5"	26D	652	711950084		312.49	Ea.	1 Ea	3 Ea.	15 Ea.	EO
			10	639	711950085		301.89	Ea.	1 Ea	3 Ea.	15 Ea.	EO
	<b>STSCB1949R</b> Stainless Steel Full Mortise Swing-Clear Hvy Weight Hinge, Non Removable Pin for 1/8" in 2" beveled edge doors	4.5"	32D	630		✓	353.91	Ea.	1 Ea	3 Ea.	15 Ea.	EO
		5"	32D	630		✓	391.42	Ea.	1 Ea	3 Ea.	15 Ea.	EO

All prices are for items furnished with screws (as specified in catalog) unless otherwise stated in price list.  
\* To price other finishes on architectural items – See pricing extras.

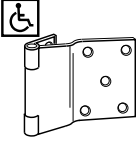
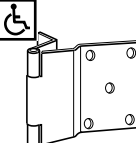
\*\* For conversion pins and decorative tips – See Miscellaneous Architectural Parts.  
(X) Item must be ordered in these increments.

# Three Knuckle Concealed Bearing Architectural Hinges (cont.) Hinges & Door Accessories

Model	Size	Finish	BHMA	EDP #	Stock Item	List Price	UOM	Order Multiple	Box Qty	Carton Qty	MPG
 <b>CB1951R</b> Steel Full Surface Swing-Clear Hvy Weight Hinge	5"	P	600	71950086		268.33	Ea.	1Ea	3 Ea	15 Ea.	EO
		26D	652	71950087		293.31	Ea.	1Ea	3 Ea	15 Ea.	EO
	<b>CB1951R NRP</b> Steel Full Surface Swing-Clear Hvy Weight Hinge, Non Removable Pin	5"	P	600	71950088		276.91	Ea.	1Ea	3 Ea	15 Ea.
<b>STSCB1951R</b> Stainless Steel Full Surface Swing-Clear Hvy Weight Hinge	5"	32D	630			377.00	Ea.	1Ea	3 Ea	15 Ea.	EO
 <b>CB1959R</b> Steel Half Surface Swing-Clear Hvy Weight Hinge	5"	26D	652	71950089		317.38	Ea.	1Ea	3 Ea	3 Ea	EO
		P	600	71950090		268.33	Ea.	1Ea	3 Ea	3 Ea	EO
	<b>STSCB1959R</b> Stainless Steel Half Surface Swing-Clear Hvy Weight Hinge	5"	32D	630			427.99	Ea.	1Ea	3 Ea	3 Ea
 <b>1960R</b> Full Mortise Std Weight Hinge Brass, Bronze, or Stainless Steel	3.5x3.5	10	612	71940052		88.44	Ea	1Ea	3 Ea	3 Ea	EO
		26D	626	71940053		92.28	Ea.	1Ea	2 Ea.	100 Ea	EO
		3	605	71940054		92.28	Ea.	1Ea	2 Ea.	100 Ea	EO
		10B	613	71940055		103.82	Ea.	1Ea	2 Ea.	100 Ea	EO
	4x4	26	625	71940056		106.67	Ea.	1Ea	2 Ea.	100 Ea.	EO
		26D	626	71940057		102.38	Ea.	1Ea	2 Ea.	100 Ea	EO
		3	605	71940058		116.81	Ea.	1Ea	2 Ea.	100 Ea	EO
		10B	613	71940059		116.81	Ea.	1Ea	2 Ea.	100 Ea	EO
	4.5x4	26	625	71940060		119.70	Ea.	1Ea	2 Ea.	100 Ea	EO
		32D	630	71940061		132.68	Ea.	1Ea	2 Ea.	100 Ea	EO
		26D	626	71940062		109.62	Ea.	1Ea	3 Ea.	48 Ea.	EO
		32D	630	71940063		125.95	Ea.	1Ea	3 Ea.	48 Ea.	EO
	4.5x4.5	3	605	71940064		125.01	Ea.	1Ea	3 Ea.	48 Ea.	EO
		26	625	71940065		125.01	Ea.	1Ea	3 Ea.	48 Ea.	EO
		10B	613	71940066		125.01	Ea.	1Ea	3 Ea.	48 Ea.	EO
		26D	626	71940067		98.08	Ea.	1Ea	3 Ea.	48 Ea.	EO
	5x4	3	605	71940068		111.52	Ea.	1Ea	3 Ea.	48 Ea.	EO
		26	625	71940069		125.01	Ea.	1Ea	3 Ea.	48 Ea.	EO
		10B	613	71940070		111.52	Ea.	1Ea	3 Ea.	48 Ea.	EO
		32D	630	71940071		125.95	Ea.	1Ea	3 Ea.	48 Ea	EO
 <b>1960R NRP</b> Full Mortise Std Weight Hinge Non Removable Pin Brass, Bronze, or Stainless Steel	3.5x3.5	26D	626	71940072		116.35	Ea.	1Ea	3 Ea.	30 Ea.	EO
		10	612	71940073		97.02	Ea.	1Ea	2 Ea.	100 Ea.	EO
		26	625	71940074		115.25	Ea.	1Ea	2 Ea.	100 Ea.	EO
		10B	613	71940075		112.40	Ea.	1Ea	2 Ea.	100 Ea.	EO
	4.5x4	32D	630	71940076		121.04	Ea.	1Ea	2 Ea.	100 Ea.	EO
		26D	626	71940080		118.20	Ea.	1Ea	3 Ea.	48 Ea.	EO
		3	605	71940082		133.59	Ea.	1Ea	3 Ea.	48 Ea.	EO
		26	625	71940083		133.59	Ea.	1Ea	3 Ea.	48 Ea.	EO
4.5x4.5	10B	613	71940084		133.59	Ea.	1Ea	3 Ea.	48 Ea.	EO	
	32D	630	71940081		134.53	Ea.	1Ea	3 Ea.	48 Ea	EO	
	26	625	71940087		133.59	Ea.	1Ea	3 Ea.	48 Ea	EO	
	26D	626	71940085	✓	106.66	Ea.	1Ea	3 Ea.	48 Ea	EO	
 <b>CB1960R</b> Full Mortise Std Weight Hinge Brass, Bronze, or Stainless Steel	3.5"x3.5"	3	605	71940086		120.10	Ea.	1Ea	3 Ea.	48 Ea	EO
		26D	626	71940169		128.35	Ea.	1Ea	2 Ea.	100 Ea.	EO
		10	612	71940170		126.91	Ea.	1Ea	2 Ea.	100 Ea.	EO
		10B	613	71940171		132.68	Ea.	1Ea	2 Ea.	100 Ea.	EO
	4"x4"	32D	630	71940172		149.99	Ea.	1Ea	2 Ea.	100 Ea.	EO
		26D	626	71940173		127.89	Ea.	1Ea	3 Ea.	48 Ea	EO
		3	605	71940174		130.78	Ea.	1Ea	3 Ea.	48 Ea	EO
		10B	613	71940175		130.78	Ea.	1Ea	3 Ea.	48 Ea	EO
		32D	630	71940176		128.84	Ea.	1Ea	3 Ea.	48 Ea	EO





# Three Knuckle Concealed Bearing Architectural Hinges (cont.) Hinges & Door Accessories

Model	Size	Finish	BHMA	EDP #	Stock Item	List Price	UOM	Order Multiple	Box Qty	Carton Qty	MPG
 <b>CB1960R (cont.)</b> Full Mortise Std Weight Hinge, Brass, Bronze, or Stainless Steel	4.5"x4"	26D	626	71940177		107.70	Ea.	1Ea	3 Ea.	48 Ea	EO
		626W	626W	71950290		104.63	Ea.	1Ea	3 Ea.	48 Ea	EO
		10B	613	71940178		143.27	Ea.	1Ea	3 Ea.	48 Ea	EO
		26	625	71940179		112.51	Ea.	1Ea	3 Ea.	48 Ea	EO
		3	605	71940180		160.58	Ea.	1Ea	3 Ea.	48 Ea	EO
		32D	630	71940181	✓	141.36	Ea.	1Ea	3 Ea.	48 Ea	EO
		630W	630W	71950291		137.34	Ea.	1Ea	3 Ea.	48 Ea	EO
		32	629	71940182		165.41	Ea.	1Ea	3 Ea.	48 Ea	EO
		10	612	71940183		107.70	Ea.	1Ea	3 Ea.	48 Ea	EO
		4	606	71940184		105.75	Ea.	1Ea	3 Ea.	48 Ea	EO
	4.5"x4.5"	4	606	71940185		107.70	Ea.	1Ea	3 Ea.	48 Ea	EO
		10	612	71940186		107.70	Ea.	1Ea	3 Ea.	48 Ea	EO
		26D	626	71940187	✓	107.70	Ea.	1Ea	3 Ea.	48 Ea	EO
		626W	626W	71950288		104.63	Ea.	1Ea	3 Ea.	48 Ea	EO
		26	625	71940188		143.27	Ea.	1Ea	3 Ea.	48 Ea	EO
		3	605	71940189		143.27	Ea.	1Ea	3 Ea.	48 Ea	EO
		10B	613	71940190		143.27	Ea.	1Ea	3 Ea.	48 Ea	EO
		32D	630	71940191	✓	141.36	Ea.	1Ea	3 Ea.	48 Ea	EO
		630W	630W	71950289		137.34	Ea.	1Ea	3 Ea.	48 Ea	EO
		5"x4"	26D	626	71940192		174.06	Ea.	1Ea	3 Ea.	30 Ea
	5"x4.5"	10B	613	71940193		192.32	Ea.	1Ea	3 Ea.	30 Ea	EO
		3	605	71940194		173.11	Ea.	1Ea	3 Ea.	30 Ea	EO
		32D	630	71940195		196.19	Ea.	1Ea	3 Ea.	30 Ea	EO
	5"x5"	630W	630W	71950292		202.75	Ea.	1Ea	3 Ea.	48 Ea	E
		3	605	71940196		173.11	Ea.	1Ea	3 Ea.	30 Ea	EO
		26D	626	71940197		174.06	Ea.	1Ea	3 Ea.	30 Ea	EO
		26	625	71940198		174.06	Ea.	1Ea	3 Ea.	30 Ea	EO
		10B	613	71940199		192.32	Ea.	1Ea	3 Ea.	30 Ea	EO
32D		630	71940200		208.69	Ea.	1Ea	3 Ea.	30 Ea	EO	
3.5"x3.5"		10B	613	71940201		141.26	Ea.	1Ea	2 Ea.	100 Ea.	EO
		32D	630	71940202		158.57	Ea.	1Ea	2 Ea.	100 Ea.	EO
		26D	626	71940203		136.93	Ea.	1Ea	2 Ea.	100 Ea.	EO
		4.5"x4"	26D	626	71940204	✓	116.28	Ea.	1Ea	3 Ea.	48 Ea.
	626W		626W	71950295		113.21	Ea.	1Ea	3 Ea.	48 Ea.	EO
	10B		613	71940205		151.85	Ea.	1Ea	3 Ea.	48 Ea.	EO
	3		605	71940206		169.16	Ea.	1Ea	3 Ea.	48 Ea.	EO
	26		625	71940207		151.85	Ea.	1Ea	3 Ea.	48 Ea.	EO
	32D		630	71940208	✓	149.94	Ea.	1Ea	3 Ea.	48 Ea.	EO
	630W		630W	71950296		113.21	Ea.	1Ea	3 Ea.	48 Ea.	EO
10	612		71940209		116.28	Ea.	1Ea	3 Ea.	48 Ea.	EO	
4	606		71940210		114.33	Ea.	1Ea	3 Ea.	48 Ea.	EO	
4.5"x4.5"	4		606	71940211		116.28	Ea.	1Ea	3 Ea.	48 Ea.	EO
	10	612	71940212		116.28	Ea.	1Ea	3 Ea.	48 Ea.	EO	
	26D	626	71940213		116.28	Ea.	1Ea	3 Ea.	48 Ea.	EO	
	626W	626W	71950293		113.21	Ea.	1Ea	3 Ea.	48 Ea.	EO	
	3	605	71940214		181.69	Ea.	1Ea	3 Ea.	48 Ea.	EO	
	10B	613	71940215		151.85	Ea.	1Ea	3 Ea.	48 Ea.	EO	
	32D	630	71940216	✓	149.94	Ea.	1Ea	3 Ea.	48 Ea.	EO	
	630W	630W	71950294		145.92	Ea.	1Ea	3 Ea.	48 Ea.	EO	
	32	629	71940217		139.53	Ea.	1Ea	3 Ea.	48 Ea.	EO	
	5"x4.5"	3	605	71940218		181.69	Ea.	1Ea	3 Ea.	30 Ea.	EO
10B		613	71940219		200.90	Ea.	1Ea	3 Ea.	30 Ea.	EO	
32D		630	71940220		204.77	Ea.	1Ea	3 Ea.	30 Ea.	EO	
630W		630W	71950297		211.33	Ea.	1Ea	3 Ea.	30 Ea.	EO	
5"x5"	26D	626	71940221		182.64	Ea.	1Ea	3 Ea.	30 Ea.	EO	
	26	625	71940222		182.64	Ea.	1Ea	3 Ea.	30 Ea.	EO	
	10B	613	71940223		200.90	Ea.	1Ea	3 Ea.	30 Ea.	EO	
	32D	630	71940224		217.27	Ea.	1Ea	3 Ea.	30 Ea.	EO	

All prices are for items furnished with screws (as specified in catalog) unless otherwise stated in price list.  
 \* To price other finishes on architectural items – See pricing extras.

\*\* For conversion pins and decorative tips – See Miscellaneous Architectural Parts.  
 (X) Item must be ordered in these increments.



# Three Knuckle Concealed Bearing Architectural Hinges (cont.) Hinges & Door Accessories



	Model	Size	Finish	BHMA	EDP #	Stock Item	List Price	UOM	Order Multiple	Box Qty	Carton Qty	MPG		
	<b>CB1961R</b> Full Mortise Hvy Weight Hinge Brass, Bronze, or Stainless Steel	4.5"x4"	32D	630	711950091		260.63	Ea.	1Ea	3 Ea.	30 Ea	EO		
			630W	630W	711950301		253.22	Ea.	1Ea	3 Ea.	30 Ea.	EO		
			10B	613	711950092		237.55	Ea.	1Ea	3 Ea.	30 Ea.	EO		
			26D	626	711950093		208.69	Ea.	1Ea	3 Ea.	30 Ea.	EO		
			626W	626W	711950300		202.75	Ea.	1Ea	3 Ea.	30 Ea.	EO		
			26	625	711950094		237.55	Ea.	1Ea	3 Ea.	30 Ea.	EO		
			3	605	711950095		237.55	Ea.	1Ea	3 Ea.	30 Ea.	EO		
			4	606	711950096		183.66	Ea.	1Ea	3 Ea.	30 Ea.	EO		
		10	612	711950097		195.21	Ea.	1Ea	3 Ea.	30 Ea.	EO			
		4.5"x4.5"	10	612	711950098		190.42	Ea.	1Ea	3 Ea.	30 Ea.	EO		
			26D	626	711950099		208.69	Ea.	1Ea	3 Ea.	30 Ea.	EO		
			626W	626W	711950298		202.75	Ea.	1Ea	3 Ea.	30 Ea.	EO		
			10B	613	711950100		237.55	Ea.	1Ea	3 Ea.	30 Ea.	EO		
			26	625	711950101		237.55	Ea.	1Ea	3 Ea.	30 Ea.	EO		
			32D	630	711950102	✓	268.33	Ea.	1Ea	3 Ea.	30 Ea.	EO		
			630W	630W	711950299		260.70	Ea.	1Ea	3 Ea.	30 Ea.	EO		
			32	629	711950103		251.02	Ea.	1Ea	3 Ea.	30 Ea.	EO		
		5"x4.5"	26D	626	711950104		233.70	Ea.	1Ea	3 Ea.	30 Ea.	EO		
			626W	626W	711950302		227.05	Ea.	1Ea	3 Ea.	24 Ea.	EO		
			10B	613	711950105		293.31	Ea.	1Ea	3 Ea.	24 Ea.	EO		
			32D	630	711950106	✓	312.57	Ea.	1Ea	3 Ea.	24 Ea.	EO		
			630W	630W	711950303		303.68	Ea.	1Ea	3 Ea.	24 Ea.	EO		
		5"x5"	32	629	711950107		350.08	Ea.	1Ea	3 Ea.	24 Ea.	EO		
			26D	626	711950108		236.59	Ea.	1Ea	3 Ea.	24 Ea.	EO		
			10B	613	711950109		293.31	Ea.	1Ea	3 Ea.	24 Ea.	EO		
			32D	630	711950110		312.57	Ea.	1Ea	3 Ea.	24 Ea.	EO		
		6"x4.5"	630W	630W	711950304		303.68	Ea.	1Ea	3 Ea.	24 Ea.	EO		
			26D	626	711950111		392.41	Ea.	1Ea	3 Ea.	24 Ea.	EO		
			6"x5"	26D	626	711950112		392.41	Ea.	1Ea	3 Ea.	24 Ea.	EO	
		6"x6"	26D	626			392.41	Ea.	1Ea	3 Ea.	24 Ea.	EO		
			<b>CB1961RNRP</b> Full Mortise Hvy Weight Hinge, Non Removable Pin Brass, Bronze, or Stainless Steel	4.5"x4"	32D	630	711950113	✓	269.21	Ea.	1Ea	3 Ea.	30 Ea.	EO
					10B	613	711950114		246.13	Ea.	1Ea	3 Ea.	30 Ea.	EO
26D	626				711950115		217.27	Ea.	1Ea	3 Ea.	30 Ea.	EO		
26	625				711950116		246.13	Ea.	1Ea	3 Ea.	30 Ea.	EO		
3	605				711950117		246.13	Ea.	1Ea	3 Ea.	30 Ea.	EO		
4	606				711950118		203.79	Ea.	1Ea	3 Ea.	30 Ea.	EO		
10	612				711950119		203.79	Ea.	1Ea	3 Ea.	30 Ea.	EO		
4.5"x4.5"	10				612	711950120		199.00	Ea.	1Ea	3 Ea.	30 Ea.	EO	
	26D			626	711950121	✓	217.27	Ea.	1Ea	3 Ea.	30 Ea.	EO		
	10B			613	711950122		246.13	Ea.	1Ea	3 Ea.	30 Ea.	EO		
	26			625	711950123		246.13	Ea.	1Ea	3 Ea.	30 Ea.	EO		
	32D			630	711950124	✓	276.91	Ea.	1Ea	3 Ea.	30 Ea.	EO		
5"x4.5"	32			629	711950125		259.60	Ea.	1Ea	3 Ea.	30 Ea.	EO		
	26D			626	711950126		242.28	Ea.	1Ea	3 Ea.	24 Ea.	EO		
	10B			613	711950127		301.89	Ea.	1Ea	3 Ea.	24 Ea.	EO		
5"x5"	32D			630	711950128	✓	321.15	Ea.	1Ea	3 Ea.	24 Ea.	EO		
	32			629	711950129		321.15	Ea.	1Ea	3 Ea.	24 Ea.	EO		
	26D			626	711950130		245.17	Ea.	1Ea	3 Ea.	24 Ea.	EO		
	10B			613	711950131		301.89	Ea.	1Ea	3 Ea.	24 Ea.	EO		
	<b>IHTCB1961R</b> Institutional Full Mortise Hvy Weight Hinge Stainless Steel			4.5"x4.5"	32D	630	711950132		279.87	Ea.	1Ea	3 Ea.	30 Ea.	EO
		5"x4.5"	32D	630	711950133		268.33	Ea.	1Ea	3 Ea.	24 Ea.	EO		
	<b>CB1967R LH</b> Pivot-Reinforced Hvy Weight Hinge Set Bronze, or Stainless Steel for Square or Beveled Edge Doors	5"x4.5"	26D	626	711950134		989.61	Set	1Set	1Set	1Set	EO		
			<b>CB1967R RH</b> Pivot-Reinforced Hvy Weight Hinge Set Bronze, or Stainless Steel for Square or Beveled Edge Doors	26D	626	711950135		989.61	Set	1Set	1Set	1Set	EO	

Must be ordered as a complete set.

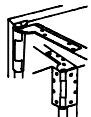
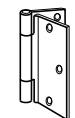
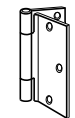
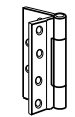
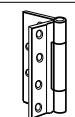
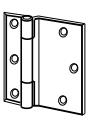
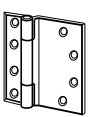







# Three Knuckle Concealed Bearing Architectural Hinges (cont.) Hinges & Door Accessories

	Model	Size	Finish	BHMA	EDP #	Stock Item	List Price	UOM	Order Multiple	Box Qty	Carton Qty	MPG	
 <p>Must be ordered as a complete set.</p>	<b>CB1968R LH</b> Pivot-Reinforced Hvy Weight Hinge Set Bronze, or Stainless Steel for Square Edge Doors	5"X4.5"	26D	626	71950136		989.61	Set	1 Set	1 Set	1 Set	EO	
			10B	613	71950137		909.37	Set	1 Set	1 Set	1 Set	EO	
			32D	630	71950138		1211.80	Set	1 Set	1 Set	1 Set	EO	
		<b>CB1968R RH</b> Pivot-Reinforced Hvy Weight Hinge Set Bronze, or Stainless Steel for Square Edge Doors	5"X4.5"	26D	626	71950139		989.61	Set	1 Set	1 Set	1 Set	EO
				10B	613	71950140		923.24	Set	1 Set	1 Set	1 Set	EO
				32D	630	71950141		1211.80	Set	1 Set	1 Set	1 Set	EO
 <p>Must be ordered as a complete set.</p>	<b>CB1969R LH</b> Pivot-Reinforced Hvy Weight Hinge Set Bronze, or Stainless Steel for Beveled Edge Doors	5"X4.5"	26D	626	71950142		989.61	Set	1 Set	1 Set	1 Set	EO	
			10B	613	71950143		923.24	Set	1 Set	1 Set	1 Set	EO	
			32D	630	71950144		1211.80	Set	1 Set	1 Set	1 Set	EO	
		<b>CB1969R RH</b> Pivot-Reinforced Hvy Weight Hinge Set Bronze, or Stainless Steel for Beveled Edge Doors	5"X4.5"	26D	626	71950145		989.61	Set	1 Set	1 Set	1 Set	EO
				10B	613	71950146		923.24	Set	1 Set	1 Set	1 Set	EO
				32D	630	71950147		1211.80	Set	1 Set	1 Set	1 Set	EO
	<b>CB1970R</b> Half Surface Std Weight Hinge Brass, Bronze, or Stainless Steel	4.5"	26D	626	71940225		445.31	Ea.	1 Ea.	3 Ea.	30 Ea.	EO	
			10B	613	71940226		499.17	Ea.	1 Ea.	3 Ea.	30 Ea.	EO	
			32D	630	71940227		594.40	Ea.	1 Ea.	3 Ea.	30 Ea.	EO	
		5"	26D	626	71940228		490.52	Ea.	1 Ea.	3 Ea.	24 Ea.	EO	
			32D	630	71940229		669.42	Ea.	1 Ea.	3 Ea.	24 Ea.	EO	
	<b>CB1971R</b> Half Surface Hvy Weight Hinge Brass, Bronze, or Stainless Steel	4.5"	26D	626	71950148		445.31	Ea.	1 Ea.	3 Ea.	30 Ea.	EO	
			10B	613	71950149		499.17	Ea.	1 Ea.	3 Ea.	30 Ea.	EO	
			32D	630	71950150		592.47	Ea.	1 Ea.	3 Ea.	30 Ea.	EO	
		5"	26D	626	71950151		554.96	Ea.	1 Ea.	3 Ea.	30 Ea.	EO	
			32D	630	71950152		554.96	Ea.	1 Ea.	3 Ea.	30 Ea.	EO	
			10B	613	71950153		733.86	Ea.	1 Ea.	3 Ea.	30 Ea.	EO	
	<b>CB1980R</b> Half Mortise Std Weight Hinge Brass, Bronze, or Stainless Steel	4.5"	26D	626	71940230		376.05	Ea.	1 Ea.	3 Ea.	30 Ea.	EO	
			10B	613	71940231		422.22	Ea.	1 Ea.	3 Ea.	30 Ea.	EO	
			32D	630	71940232		490.52	Ea.	1 Ea.	3 Ea.	30 Ea.	EO	
		5"	32D	630	71940233		594.40	Ea.	1 Ea.	3 Ea.	24 Ea.	EO	
			10B	613	71940234		511.67	Ea.	1 Ea.	3 Ea.	24 Ea.	EO	
	<b>CB1981R</b> Half Mortise Hvy Weight Hinge Brass, Bronze, or Stainless Steel	4.5"	10	612	71950154		472.22	Ea.	1 Ea.	3 Ea.	30 Ea.	EO	
			10B	613	71950155		472.22	Ea.	1 Ea.	3 Ea.	30 Ea.	EO	
			32D	630	71950156		611.71	Ea.	1 Ea.	3 Ea.	30 Ea.	EO	
		5"	32D	630	71950157		716.55	Ea.	1 Ea.	3 Ea.	24 Ea.	EO	
			10B	613	71950158		553.02	Ea.	1 Ea.	3 Ea.	24 Ea.	EO	
	<b>CB1990R</b> Full Surface Std Weight Hinge Brass, Bronze, or Stainless Steel	4.5"	26D	626	71940235		434.71	Ea.	1 Ea.	3 Ea.	30 Ea.	EO	
			10B	613	71940236		488.59	Ea.	1 Ea.	3 Ea.	30 Ea.	EO	
			32D	630	71940237		522.26	Ea.	1 Ea.	3 Ea.	30 Ea.	EO	
		5"	32D	630	71940238		596.30	Ea.	1 Ea.	3 Ea.	24 Ea.	EO	
			10B	613	71940239		546.30	Ea.	1 Ea.	3 Ea.	24 Ea.	EO	
	<b>CB1991R</b> Full Surface Hvy Weight Hinge Brass, Bronze, or Stainless Steel	4.5"	10	612	71950160		500.13	Ea.	1 Ea.	3 Ea.	30 Ea.	EO	
			10B	613	71950161		500.13	Ea.	1 Ea.	3 Ea.	30 Ea.	EO	
			32D	630	71950162		594.40	Ea.	1 Ea.	3 Ea.	30 Ea.	EO	
		5"	32D	630	71950163		693.46	Ea.	1 Ea.	3 Ea.	30 Ea.	EO	
			10B	613	71950164		778.12	Ea.	1 Ea.	3 Ea.	30 Ea.	EO	
	<b>IHTCB1995 N/SRS</b> Cast Stainless Steel Institutional or Prison Full Mortise Heavy Weight CB w/out Shear Resistant Stud	4.5"x4.5"	P	600	71925499		269.29	Ea.	1 Ea.	3 Ea.	30 Ea.	EO	
			32D	630	71925498	✓	298.14	Ea.	1 Ea.	3 Ea.	30 Ea.	EO	
		<b>IHTCB1995 SRS</b> Cast Stainless Steel Institutional or Prison Full Mortise Heavy Weight CB w/Shear Resistant Stud	4.5"x4.5"	P	600	71925497	✓	293.31	Ea.	1 Ea.	3 Ea.	30 Ea.	EO
				32D	630	71925495	✓	319.28	Ea.	1 Ea.	3 Ea.	30 Ea.	EO

Model	Size	Finish	BHMA	EDP #	Stock Item	List Price	UOM	Order Multiple	Box Qty	Carton Qty	MPG	
 <b>2060R</b> Steel or Stainless Steel Spring Hinge Standard Weight	3.5"x3.5"	P	600	71420744	✓	68.30	Ea.	1Ea.	2 Ea.	50 Ea.	E3	
		4	633	71420742		69.20	Ea.	1Ea.	2 Ea.	50 Ea.	E3	
		10	639	71420746		72.08	Ea.	1Ea.	2 Ea.	50 Ea.	E3	
		26D	652	71420750	✓	73.53	Ea.	1Ea.	2 Ea.	50 Ea.	E3	
		10A	641	71420748		83.63	Ea.	1Ea.	2 Ea.	50 Ea.	E3	
		3	632	71420749	✓	83.63	Ea.	1Ea.	2 Ea.	50 Ea.	E3	
		26	651	71420752		83.63	Ea.	1Ea.	2 Ea.	50 Ea.	E3	
		32D	630	71422310		184.62	Ea.	1Ea.	2 Ea.	50 Ea.	E3	
		32	629	71422311		200.49	Ea.	1Ea.	2 Ea.	50 Ea.	E3	
	4"x4"	P	600	71422100	✓	76.81	Ea.	1Ea.	2 Ea.	50 Ea.	E3	
		4	633	71422102	✓	77.85	Ea.	1Ea.	2 Ea.	50 Ea.	E3	
		10	639	71422104		82.18	Ea.	1Ea.	2 Ea.	50 Ea.	E3	
		26D	652	71422106	✓	85.07	Ea.	1Ea.	2 Ea.	50 Ea.	E3	
		10A	641	71422108		90.84	Ea.	1Ea.	2 Ea.	50 Ea.	E3	
		3	632	71422110	✓	90.84	Ea.	1Ea.	2 Ea.	50 Ea.	E3	
		32D	630	71422312		209.15	Ea.	1Ea.	2 Ea.	50 Ea.	E3	
		32	629			251.97	Ea.	1Ea.	2 Ea.	50 Ea.	E3	
		4.5"x4"	P	600	71420920	✓	95.20	Ea.	1Ea.	3 Ea.	48 Ea.	E3
	19		631	71950321	✓	91.69	Ea.	1Ea.	3 Ea.	48 Ea.	E0	
	4		633	71420407		95.20	Ea.	1Ea.	3 Ea.	48 Ea.	E3	
	10		639	71420921		95.20	Ea.	1Ea.	3 Ea.	48 Ea.	E3	
	26D		652	71420923	✓	101.92	Ea.	1Ea.	3 Ea.	48 Ea.	E3	
	26		651	71420926	✓	111.52	Ea.	1Ea.	3 Ea.	48 Ea.	E3	
	3		632	71420924		111.52	Ea.	1Ea.	3 Ea.	48 Ea.	E3	
	10A		641	71420925		111.52	Ea.	1Ea.	3 Ea.	48 Ea.	E3	
	32D		630	71422328	✓	233.70	Ea.	1Ea.	3 Ea.	48 Ea.	E3	
	19		631	71950321	✓	91.69	Ea.	1Ea.	3 Ea.	48 Ea.	E0	
	32		629	71422329		251.97	Ea.	1Ea.	3 Ea.	48 Ea.	E3	
	4.5"x4.5"		P	600	71420935	✓	95.20	Ea.	1Ea.	3 Ea.	48 Ea.	E3
			19	631	71950322	✓	91.69	Ea.	1Ea.	3 Ea.	48 Ea.	E0
			4	633	71420936	✓	95.20	Ea.	1Ea.	3 Ea.	48 Ea.	E3
			10	639	71420937	✓	95.20	Ea.	1Ea.	3 Ea.	48 Ea.	E3
26D		652	71420939	✓	101.92	Ea.	1Ea.	3 Ea.	48 Ea.	E3		
3		632	71420940	✓	111.52	Ea.	1Ea.	3 Ea.	48 Ea.	E3		
10A		641	71420941	✓	111.52	Ea.	1Ea.	3 Ea.	48 Ea.	E3		
26		651	71420942	✓	111.52	Ea.	1Ea.	3 Ea.	48 Ea.	E3		
32D		630	71422314	✓	233.70	Ea.	1Ea.	3 Ea.	48 Ea.	E3		
32		629	71422315		251.97	Ea.	1Ea.	3 Ea.	48 Ea.	E3		
 <b>RD2060R</b> 1/4" Radius Corner Steel or Stainless Steel Spring Hinge Standard Weight		3.5"x3.5"	P	600	71420756		127.73	Ea.	1Ea.	2 Ea.	50 Ea.	E3
			4	633	71420754		128.63	Ea.	1Ea.	2 Ea.	50 Ea.	E3
			26D	652	71420762	✓	132.96	Ea.	1Ea.	2 Ea.	50 Ea.	E3
			3	632	71420764		143.06	Ea.	1Ea.	2 Ea.	50 Ea.	E3
			26	651	71420765		143.06	Ea.	1Ea.	2 Ea.	50 Ea.	E3
	32D		630	71422316		244.06	Ea.	1Ea.	2 Ea.	50 Ea.	E3	
	32		629	71422317		259.93	Ea.	1Ea.	2 Ea.	50 Ea.	E3	
	4"x4"		P	600	71422150		136.25	Ea.	1Ea.	2 Ea.	50 Ea.	E3
			4	633	71422152	✓	154.63	Ea.	1Ea.	2 Ea.	50 Ea.	E3
		26D	652	71422156		144.50	Ea.	1Ea.	2 Ea.	50 Ea.	E3	
		10A	641	71422158		150.28	Ea.	1Ea.	2 Ea.	50 Ea.	E3	
		3	632	71422160		150.28	Ea.	1Ea.	2 Ea.	50 Ea.	E3	
		10B	640	71422105		173.41	Ea.	1Ea.	2 Ea.	50 Ea.	E3	
		F8	-	71422103		144.50	Ea.	1Ea.	2 Ea.	50 Ea.	E3	
		ST4B	-	71422101		173.41	Ea.	1Ea.	2 Ea.	50 Ea.	E3	
		26	651	71420803		173.41	Ea.	1Ea.	2 Ea.	50 Ea.	E3	
		32D	630	71422318		293.14	Ea.	1Ea.	2 Ea.	50 Ea.	E3	
		32	629	71422319		311.41	Ea.	1Ea.	2 Ea.	50 Ea.	E3	
		4.5"x4"	26D	652	71420982		161.36	Ea.	1Ea.	3 Ea.	48 Ea.	E3
			32D	630	71422330		293.14	Ea.	1Ea.	3 Ea.	48 Ea.	E3
			32	629	71422331		311.41	Ea.	1Ea.	3 Ea.	48 Ea.	E3
		4.5"x4.5"	26D	652	71420992		161.36	Ea.	1Ea.	3 Ea.	48 Ea.	E3
	3		632	71420994		170.96	Ea.	1Ea.	3 Ea.	48 Ea.	E3	
	32D		630	71422320		293.14	Ea.	1Ea.	3 Ea.	48 Ea.	E3	
32	629		71422321		311.41	Ea.	1Ea.	3 Ea.	48 Ea.	E3		

# Spring Hinges (cont.)

# Hinges & Door Accessories

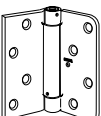
	Model	Size	Finish	BHMA	EDP #	Stock Item	List Price	UOM	Order Multiple	Box Qty	Carton Qty	MPG
	<b>RD2068R</b> 5/8" Radius Corner Steel or Stainless Steel Spring Hinge Standard Weight	3.5"x3.5"	P	600	71420768		36.01	Ea.	1Ea.	2 Ea.	50 Ea.	E3
			4	633	71420766		69.20	Ea.	1Ea.	2 Ea.	50 Ea.	E3
			26D	652	71420774		73.53	Ea.	1Ea.	2 Ea.	50 Ea.	E3
			3	632	71420775		54.77	Ea.	1Ea.	2 Ea.	50 Ea.	E3
			32D	630	71422322		190.39	Ea.	1Ea.	2 Ea.	50 Ea.	E3
			32	629	71422323		206.26	Ea.	1Ea.	2 Ea.	50 Ea.	E3
		4"x4"	P	600	71422200		38.90	Ea.	1Ea.	2 Ea.	50 Ea.	E3
			4	633	71422202		77.85	Ea.	1Ea.	2 Ea.	50 Ea.	E3
			10	639	71422204		56.21	Ea.	1Ea.	2 Ea.	50 Ea.	E3
			3	632	71422210		90.84	Ea.	1Ea.	2 Ea.	50 Ea.	E3
			26D	652	71422206		85.07	Ea.	1Ea.	2 Ea.	50 Ea.	E3
			32D	630	71422324		214.92	Ea.	1Ea.	2 Ea.	50 Ea.	E3
		4.5"x4"	32	629	71422325		230.79	Ea.	1Ea.	2 Ea.	50 Ea.	E3
			26D	652	71421032		104.81	Ea.	1Ea.	3 Ea.	48 Ea.	E3
			32D	630	71422332		239.47	Ea.	1Ea.	3 Ea.	48 Ea.	E3
		4.5"x4.5"	32	629	71422333		257.74	Ea.	1Ea.	3 Ea.	48 Ea.	E3
			P	600	71421040		75.00	Ea.	1Ea.	3 Ea.	48 Ea.	E3
			26D	652	71421042		101.92	Ea.	1Ea.	3 Ea.	48 Ea.	E3
			3	632	71421044		105.75	Ea.	1Ea.	3 Ea.	48 Ea.	E3
			32D	630	71422326		239.47	Ea.	1Ea.	3 Ea.	48 Ea.	E3
			<b>BMRD2068R</b> 5/8" Radius Corner with Benchmark Hole Pattern Spring Hinge	4"x4"	ST4C	604	71422224		40.11	Ea.	50 Ea.	50 Ea.
PCW	-				71422225		40.11	Ea.	50 Ea.	50 Ea.	50 Ea.	E3
	<b>CGRD2068R</b> 5/8xSQ BO with Castlegate Hole Pattern	4"x4"	ST4C	-	71422217		62.28	Ea.	50 Ea.	50 Ea.	50 Ea.	E3
			PCW	-	71422227		40.11	Ea.	50 Ea.	50 Ea.	50 Ea.	E3
	<b>GHRD2068R</b> 5/8xSQ BO with General Hole Pattern Spring Hinge	4"x4"	ST4C	604	71422230		40.11	Ea.	50 Ea.	50 Ea.	50 Ea.	E3
			PCW	-	71422231		40.11	Ea.	50 Ea.	50 Ea.	50 Ea.	E3
	<b>PDRD2068R</b> 5/8" Radius Corner with Perma-Door Hole Pattern Spring Hinge	4"x4"	26D	652	71422237		63.43	Ea.	1Ea.	2 Ea.	50 Ea.	E3
			4	633	71420812		40.34	Ea.	1Ea.	2 Ea.	50 Ea.	E3
	<b>PZRD2068R</b> 5/8" Radius Corner with Pease Hole Pattern Spring Hinge	4"x4"	PCW	-	71420814		66.31	Ea.	1Ea.	2 Ea.	50 Ea.	E3
	<b>SDRD2068R</b> 5/8" Radius with BEST Door Hole Pattern Spring Hinge	4X3"- 15/16"	ST4C	604	71420840		43.23	Ea.	25	25	25	E3
	<b>SDRD2068R</b> Bulk Open 5/8" Radius Steel Square Corner Spring Hinge Standard Weight with BEST Door Hole Pattern	4X3"- 15/16"	ST4C	604	71420841		41.67					

All prices are for items furnished with screws (as specified in catalog) unless otherwise stated in price list.  
\* To price other finishes on architectural items – See pricing extras.





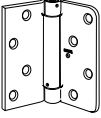

\*\* For conversion pins and decorative tips – See Miscellaneous Architectural Parts.  
(X) Item must be ordered in these increments.

# Spring Hinges (cont.)

Model	Size	Finish	BHMA	EDP #	Stock Item	List Price	UOM	Order Multiple	Box Qty	Carton Qty	MPG	
<b>TTRD2068R B0</b> 5/8" Radius Corner with Therma-Tru Hole Pattern Spring Hinge	4"x4"	PCW	-	71422229		40.11	Ea.	50 Ea.	50 Ea.	50 Ea.	E3	
	<b>2079</b> 2 Spring Hinges and 1 Free Swinging Hinge Sets	4.5"x4.5"	3	632	711827162	227.82	Set	1Set	1Set	16	E3	
			26D	652	711827188	✓	210.51	Set	1Set	1Set	16	E3
			P	600	711827170		158.57	Set	1Set	1Set	16	E3

# Miscellaneous Architectural Parts

# Hinges & Door Accessories

	Model	Size	Finish	BHMA	EDP #	Stock Item	List Price	Order Multiple	Box Qty	Carton Qty	MPG	
 For Standard weight hinges only.	<b>05-7000</b>	3.5"	STS		711057000	✓	18.87	1 Ea.	24 Ea.	240 Ea.		
	Conversion Pins for Architectural F, FBB Hinges & CB Hinges											
	<b>05-7005</b>	4"	STS		711057005		18.87	1 Ea.	24 Ea.	240 Ea.		
	<b>05-7008</b>	4.5"	STS		711057008	✓	18.87	1 Ea.	24 Ea.	240 Ea.		
 Order 2 tips per hinge. For Standard weight hinges only.	<b>05-7015</b>	5"	STS		711057015		24.64	1 Ea.	24 Ea.	240 Ea.		
	<b>05-7020</b>		3	632	711057020		4.81	1 Ea.	48 Ea.	480 Ea.		
	Crown Tips for Architectural Hinges Order 2 tips per hinge											
	<b>05-7021</b>		26	651	711057021		9.14	1 Ea.	48 Ea.	480 Ea.		
	<b>05-7022</b>		4	633	711057022		9.14	1 Ea.	48 Ea.	480 Ea.		
 Order 2 tips per hinge. For Standard weight hinges only.	<b>05-7023</b>		26D	652	711057023		9.14	1 Ea.	48 Ea.	480 Ea.		
	<b>05-7030</b>		3	632	711057030		4.81	1 Ea.	48 Ea.	480 Ea.		
	Ball Tips for Architectural Hinges Order 2 tips per hinge											
	<b>05-7031</b>		26	651	711057031		4.81	1 Ea.	48 Ea.	480 Ea.		
	<b>05-7032</b>		4	633	711057032		4.81	1 Ea.	48 Ea.	480 Ea.		
 Order 2 tips per hinge. For Standard weight hinges only.	<b>05-7033</b>		26D	652	711057033		4.81	1 Ea.	48 Ea.	480 Ea.		
	<b>05-7040</b>		3	632	711057040		4.81	1 Ea.	48 Ea.	480 Ea.		
	Steeple Tips for Architectural Hinges Order 2 tips per hinge											
	<b>05-7041</b>		26	651	711057041		4.81	1 Ea.	48 Ea.	480 Ea.		
 Order 2 tips per hinge. For Standard weight hinges only.	<b>05-7042</b>		4	633	711057042		4.81	1 Ea.	48 Ea.	480 Ea.		
	<b>05-7043</b>		26D	652	711057043		4.81	1 Ea.	48 Ea.	480 Ea.		
	<b>57-0100</b>	12-24 x 1/2"	26D	652	711570100	✓	86.43	1 Box	100 Ea.	100 Ea.		
 Steel Machine Screws For Architectural Hinges	<b>57-0102</b>	12-24 x 1/2"	P	600	711570102		63.34	1 Box	100 Ea.	100 Ea.		
	<b>57-0113</b>	12 x 1-1/4"	26D	652	711570113		80.66	1 Box	100 Ea.	100 Ea.		
	<b>57-0115</b>	12 x 1-1/4"	P	600	711570115		51.80	1 Box	100 Ea.	100 Ea.		
	<b>57-0116</b>	12 x 1-1/4"	10A	641	711570116		95.08	1 Box	100 Ea.	100 Ea.		
	<b>57-0117</b>	12 x 1-1/4"	3	632	711570117		92.20	1 Box	100 Ea.	100 Ea.		
	<b>57-0201</b>	12 x 1-1/4"	3	632	711570201		210.51	1 Box	100 Ea.	100 Ea.		
	Solid Brass Wood Screws For Architectural Hinges											

(X) Item must be ordered in these increments. \*For orders having less than the order multiple quantity, add 1/4 (1.5 multiplier) to the net price.

# EDP Number to Class Number Cross Reference

# Hinges & Door Accessories

EDP Number	Class Number	Size	Finish	UPC#
711029388	BB852	5X6	P	887838068590
711029468	BB855	5x6	P	887838070012
711033962	F191	4.5X4.5	26D	887838070050
711033963	F191	4.5X4.5	4	887838070067
711033966	F191	4.5X4.5	3	887838068606
711033970	F191NRP	4.5X4.5	3	887838070074
711033974	F191NRP	4.5X4.5	26D	887838070098
711033979	F191NRP	4.5X4.5	32	887838091239
711033980	F191NRP	4.5X4.5	4	887838091246
711033981	F191NRP	4X4	P	887838091253
711033993	F191	4.5X4.5	10	887838070104
711033994	F191	4.5X4.5	10B	887838070111
711034300	F191NRP	4X4	32	887838070128
711034302	F191	4X4	32D	887838070135
711034303	F191	4X4	32	887838070142
711036010	F191NRP	3.5X3.5	10B	887838070159
711036011	F191NRP	3.5X3.5	26	887838091260
711036055	F191NRP	3.5X3.5	3	887838070166
711036056	F191	3.5X3.5	26D	887838070173
711036057	F191	3.5X3.5	3	887838070180
711036059	F191	3.5X3.5	26	887838070197
711036086	F191	3.5X3.5	10	887838070203
711036087	F191	3.5X3.5	10B	887838070210
711036115	F191NRP	4X4	26	887838070227
711036116	F191	4X4	26	887838070234
711036118	F191	4X4	26D	887838070241
711036121	F191	4X4	3	887838087416
711036140	F191NRP	4X4	3	887838070258
711036143	F191NRP	4X4	26D	887838087423
711036145	F191NRP	4X4	10B	887838070265
711036147	F191	4X4	P	887838091277
711036149	F191	4X4	10B	887838070272
711036246	F191NRP	4.5X4.5	10	887838091284
711036247	F191NRP	4.5X4.5	10B	887838070289
711037185	F191NRP	3.5X3.5	32D	887838070326
711037186	F191	3.5X3.5	32D	887838070333
711037342	F191	4.5X4	32D	887838070357
711037351	F191	4.5X4.5	32	887838070371
711037353	F191	4.5X4.5	32D	887838070388
711037362	F191NRP	4.5X4.5	32D	887838070395
711040077	FBB191	4X4	32D	887838070401
711040109	FBB191	4.5X4.5	32	887838070425
711040115	FBB191NRP	4.5X4.5	32	887838070432
711040116	FBB191NRP	4.5X4.5	32D	887838087430
711040283	BB95RH	6	26D	887838070487
711040284	BB95RH	6	3	887838070494
711040285	BB95RH	6	10B	887838070500
711040286	BB95RH	6	26	887838070517
711040293	BB95LH	6	26D	887838070531
711040294	BB95LH	6	3	887838070548

EDP Number	Class Number	Size	Finish	UPC#
711040295	BB95LH	6	10B	887838070555
711040296	BB95LH	6	26	887838070562
711040801	CEFBB191-54	4.5X4.5	32D	887838070647
711040802	CEFBB199-54	4.5X4.5	32D	887838070654
711040822	FBB191	4.5X4.5	32D	887838070678
711041258	FBB191NRP	4.5X4	26D	887838087447
711041586	FBB221 RH	5x4.5	26D	887838070685
711041608	FBB222 LH	5x4.5	26D	887838070739
711041613	FBB222 RH	5x4.5	26D	887838070746
711041619	FBB223 LH	5x4.5	26D	887838070760
711041620	FBB223 LH	5x4.5	10B	887838070777
711041621	FBB223 RH	5x4.5	26D	887838070784
711041622	FBB223 RH	5x4.5	10B	887838070791
711041661	225 R		P	887838070807
711041761	FBB221 LH	5x4.5	26D	887838070845
711041782	225 R		2C	887838070852
711041865	FBB223 LH	5x4.5	32D	887838070906
711041881	FBB223 RH	5x4.5	32D	887838091291
711043332	FBB191NRP	3.5X3.5	3	887838091307
711043334	FBB191	3.5X3.5	3	887838070982
711043335	FBB191	3.5X3.5	26D	887838070999
711043361	FBB191NRP	4X4	26	887838091413
711043362	FBB191	4X4	26D	887838071002
711043363	FBB191	4X4	26	887838071019
711043364	FBB191	4X4	3	887838071026
711043367	FBB191NRP	4X4	3	887838071033
711043372	FBB191	4X4	10	887838071057
711043374	FBB191	4X4	10B	887838071064
711043379	FBB191NRP	4X4	10B	887838071071
711043389	FBB191	4.5X4.5	26	887838071088
711043392	FBB191	4.5X4.5	26D	887838071095
711043393	FBB191NRP	4.5X4.5	26D	887838087492
711043394	FBB191NRP	4.5X4.5	P	887838071101
711043395	FBB191NRP	4.5X4.5	3	887838071118
711043396	FBB191NRP	4.5X4.5	4	887838071125
711043399	FBB191	4.5X4.5	P	887838071132
711043401	FBB191NRP	4.5X4.5	26	887838071149
711043402	FBB191	4.5X4.5	3	887838071156
711043403	FBB191	4.5X4.5	4	887838071163
711043422	FBB191	4.5X4.5	10	887838071170
711043435	FBB191	4.5X4.5	10B	887838071194
711043438	FBB191NRP	4.5X4.5	10	887838071217
711043439	FBB191NRP	4.5X4.5	10B	887838071224
711043522	FBB191	5X5	3	887838071293
711043540	FBB191NRP	5X5	3	887838071309
711043655	FBB191NRP	3.5X3.5	32D	887838071323
711043659	FBB191	3.5X3.5	32D	887838071330
711043663	FBB191	5X5	10B	887838071354
711043667	FBB191NRP	5X5	10B	887838071378
711043780	FBB191NRP	5X5	32D	887838071385

## EDP Number to Class Number Cross Reference (cont.)

## Hinges & Door Accessories

EDP Number	Class Number	Size	Finish	UPC#
711043782	FBB191	5X5	32D	887838087409
711043814	FBB191	4.5X4	15	887838071392
711043824	FBB191NRP	4.5X4	15	887838071408
711044156	FBB191	4.5X4	32D	887838069870
711044161	FBB191NRP	4.5X4	32D	887838069887
711044340	FBB191	5X4.5	32D	887838071439
711044350	FBB191NRP	5X4.5	32D	887838071446
711044503	FBB199	4.5X4	26D	887838069900
711044504	FBB199NRP	4.5X4	26D	887838071453
711044518	FBB199	4.5X4	32D	887838087720
711044520	FBB199NRP	4.5X4	32D	887838087744
711044781	FBB199NRP	4.5X4.5	32	887838071484
711044783	FBB199	4.5X4.5	32D	887838071491
711044784	FBB199	4.5X4.5	32	887838071507
711044786	FBB199NRP	4.5X4.5	32D	887838087751
711044932	FBB199	4.5X4.5	10	887838071552
711044933	FBB199	4.5X4.5	10B	887838071569
711044938	FBB199NRP	4.5X4.5	10	887838071583
711044940	FBB199NRP	4.5X4.5	10B	887838087768
711044950	FBB199NRP	4.5X4.5	4	887838071606
711044982	FBB199NRP	5X4.5	32D	887838087775
711044991	FBB199NRP	4.5X4.5	3	887838071620
711044992	FBB199	4.5X4.5	26D	887838087782
711044994	FBB199	4.5X4.5	3	887838071637
711044997	FBB199	4.5X4.5	4	887838071644
711044998	FBB199NRP	4.5X4.5	26D	887838071651
711045032	FBB199	5X4.5	26D	887838071682
711045045	FBB199NRP	5X4.5	26D	887838071699
711045071	FBB199NRP	5X4.5	32	887838071712
711045073	FBB199	5X4.5	32D	887838071729
711045074	FBB199	5X4.5	32	887838071736
711045094	FBB199	5X5	3	887838071750
711045101	FBB199NRP	5X5	3	887838071767
711045111	FBB199	5X5	10B	887838071781
711045119	FBB199NRP	5X5	10B	887838071804
711045122	FBB199NRP	5X5	32D	887838087805
711045162	FBB199	6X5	26D	887838071866
711045186	FBB199	6X5	10	887838091420
711045207	FBB199	6X5	32D	887838071903
711047202	FBB191	4.5X4	10	887838071941
711047236	FBB191	4.5X4	26D	887838087812
711047237	FBB191	4.5X4	4	887838091437
711047238	FBB191	4.5X4	3	887838071958
711047240	FBB191	4.5X4	P	887838091444
711047252	FBB191NRP	4.5X4	4	887838087829
711047255	FBB191NRP	4.5X4	3	887838071965
711047265	FBB191NRP	4.5X4	10	887838087836
711047266	FBB191NRP	4.5X4	10B	887838071972
711047343	FBB191	5X4	26D	887838071989
711047412	FBB191	5X4.5	26D	887838072023

EDP Number	Class Number	Size	Finish	UPC#
711047422	FBB191NRP	5X4.5	26D	887838072030
711048039	FBB199NRP	5X4.5	10B	887838072054
711050022	F179	4.5X4.5	10B	887838072061
711050026	F179	4.5X4.5	15	887838072078
711050029	F179	4.5X4.5	P	887838087843
711050030	F179	4.5X4.5	10BL	887838072085
711050031	F179NRP	4.5X4.5	10BL	887838091451
711050034	F179	4.5X4.5	10	887838072092
711050035	F179	4.5X4.5	10A	887838087850
711050036	F179	4.5X4.5	26	887838072108
711050038	F179	4.5X4.5	26D	887838072115
711050042	F179	4.5X4.5	4	887838072122
711050043	F179	4.5X4.5	3	887838087867
711050044	F179	4.5X4.5	F8	887838072139
711050046	F179	4.5X4.5	DD	887838091468
711050048	F179NRP	4.5X4.5	10B	887838072146
711050049	F179NRP	4.5X4.5	26	887838072153
711050068	F179NRP	4.5X4.5	P	887838072160
711050071	F179NRP	4.5X4.5	10A	887838072177
711050073	F179NRP	4.5X4.5	26D	887838072184
711050075	F179NRP	4.5X4.5	10	887838091475
711050085	F179BT	4.5X4.5	3	887838072191
711050086	F179ST	4.5X4.5	3	887838091482
711050125	F167	4.5	26D	887838072269
711050126	F167	4.5	P	887838087874
711050127	F167NRP	4.5	P	887838072276
711050131	F173NRP	4.5	P	887838072283
711050132	F173	4.5	P	887838072290
711050134	F173	4.5	26D	887838072306
711050145	F173NRP	4.5	26D	887838072313
711050400	F179	3.5X3.5	10B	887838072320
711050401	F179	3.5X3.5	15	887838072337
711050402	F179	3.5X3.5	15A	887838072344
711050403	F179	3.5X3.5	5	887838072351
711050405	F179BT	3.5X3.5	3	887838072375
711050408	RDF179	3.5X3.5	10B	887838072382
711050409	RDF179	3.5X3.5	15	887838072399
711050410	RDF179	3.5X3.5	15A	887838072405
711050411	RDF179	3.5X3.5	26	887838072412
711050412	RDF179	3.5X3.5	5	887838072429
711050415	RDF179	4X4	15	887838072443
711050416	RDF179	4X4	15A	887838072450
711050418	RDF179	4X4	5	887838072474
711050420	RDF179	4X4	P	887838072481
711050421	F179	3.5x3.5	10BL	887838072498
711050479	F179	3.5X3.5	1D*	887838072511
711050480	F179	3.5X3.5	P	887838072528
711050481	F179	3.5X3.5	LA	887838091499
711050482	F179	3.5X3.5	10	887838072535
711050483	F179	3.5X3.5	10A	887838072542

## EDP Number to Class Number Cross Reference (cont.)

## Hinges & Door Accessories

EDP Number	Class Number	Size	Finish	UPC#	EDP Number	Class Number	Size	Finish	UPC#
711050484	F179	3.5X3.5	26D	887838087881	711053256	F179	3X3	3	887838087942
711050486	F179	3.5X3.5	26	887838072559	711053511	F179WT	4.5X5	P	887838091550
711050489	F179	3.5X3.5	3	887838072566	711053514	F179WT	4.5X5	26D	887838073068
711050491	F179	3.5X3.5	4	887838072573	711053515	F179WT	4.5X5	10A	887838073075
711050493	F179ST	3.5X3.5	3	887838087898	711053517	F179WT	4.5X5	3	887838091567
711050498	RDF179	3.5X3.5	P	887838091505	711053754	F179WT	4.5X6	P	887838073099
711050500	RDF179	3.5X3.5	10A	887838072597	711053758	F179WT	4.5X6	10	887838091574
711050501	RDF179	3.5X3.5	26D	887838072603	711053759	F179WT	4.5X6	26D	887838073105
711050504	RDF179	3.5X3.5	3	887838072610	711053760	F179WT	4.5X6	10A	887838073112
711050505	RDF179	3.5X3.5	4	887838072627	711053761	F179WT	4.5X6	26	887838073129
711050522	F179	4X3.5	26D	887838072641	711053762	F179WT	4.5X6	3	887838073136
711050523	F179	4X3.5	3	887838072658	711053763	F179WT	4.5X6	4	887838091581
711050524	F179	4X3.5	26	887838072665	711053851	F179NRP	4.5X4	P	887838073143
711050526	RDF179	4X4	3	887838072672	711053854	F179NRP	4.5X4	3	887838091598
711050528	RDF179NRP	4X4	10A	887838072689	711053856	F179	4.5X4	15	887838073150
711050530	RDF179	4X4	10A	887838072696	711053870	F179	4.5X4	P	887838069597
711050532	RDF179	4X4	4	887838072702	711053874	F179	4.5X4	10	887838073167
711050533	RDF179NRP	4X4	26D	887838072719	711053875	F179	4.5X4	10A	887838087966
711050535	RDF179NRP	4X4	3	887838091512	711053876	F179	4.5X4	26	887838073174
711050537	RDF179	4X4	26D	887838072726	711053877	F179	4.5X4	3	887838073181
711050539	F179NRP	4X4	26D	887838072733	711053878	F179	4.5X4	26D	887838087973
711050541	F179	4X4	P	887838072740	711053879	F179	4.5X4	4	887838073198
711050546	F179	4X4	10A	887838072757	711053891	F179NRP	4.5X4	26D	887838073204
711050547	F179	4X4	26	887838087904	711054501	F248	3.5	P	887838073228
711050549	F179	4X4	26D	887838087911	711054503	F248	3.5	4	887838073235
711050551	F179	4X4	3	887838072764	711054505	F248	3.5	26D	887838073242
711050552	F179	4X4	4	887838072771	711054509	F248	3.5	3	887838087980
711050554	F179	4X4	F8	887838072788	711054827	F179WT	3.5X5	4	887838073259
711050556	F179	4X4	10*	887838072795	711054828	F179WT	3.5X5	3	887838073266
711050558	RDF179NRP	4X4	4	887838091529	711054830	F179WT	3.5X5	P	887838073280
711050559	F179ST	4X4	3	887838072801	711054833	F179WT	3.5X5	26D	887838073297
711050561	F179BT	4X4	3	887838072818	711054834	F179WT	3.5X5	10A	887838091604
711050569	F179	4X4	10B	887838072832	711054835	F179WT	3.5X5	26	887838069603
711050571	F179	4X4	15	887838072849	711054837	F179WT	3.5X6	P	887838073310
711050572	F179	4X4	15A	887838072856	711054840	F179WT	3.5X6	26D	887838073327
711050573	F179	4X4	5	887838072863	711054841	F179WT	3.5X6	10A	887838091611
711050575	F179	4x4	10BL	887838072887	711054843	F179WT	3.5X6	3	887838073334
711050736	F179	5X4	26D	887838072924	711054844	F179WT	3.5X6	4	887838073341
711050742	F179	5X4	3	887838072931	711055102	F179NRP	4X4	P	887838073358
711050816	F179	5X4.5	26D	887838072955	711055111	F179WT	4X6	3	887838073372
711050844	F179NRP	5X5	P	887838072962	711055112	F179WT	4X5	4	887838073389
711050845	F179	5X5	P	887838072979	711055113	F179WT	4X5	3	887838073396
711050853	F179	5X5	26D	887838072986	711055115	F179WT	4X5	P	887838073419
711050863	F179NRP	5X5	26D	887838072993	711055118	F179WT	4X5	26D	887838073426
711050878	F179WT	5X8	26D	887838091536	711055119	F179WT	4X5	10A	887838073433
711053054	F179	3.5X3	4	887838073020	711055121	F179WT	4X5	26	887838073457
711053200	F179	3X3	10B	887838073037	711055122	F179WT	4X6	P	887838073464
711053201	F179	3X3	P	887838073044	711055124	F179WT	4X6	10	887838073471
711053251	F179BT	3X3	3	887838087928	711055125	F179WT	4X6	26D	887838073488
711053252	F179	3X3	26D	887838087935	711055126	F179WT	4X6	10A	887838073495



## EDP Number to Class Number Cross Reference (cont.)

## Hinges & Door Accessories

EDP Number	Class Number	Size	Finish	UPC#
711055128	F179WT	4X7	P	887838073501
711055131	F179WT	4X7	26D	887838073518
711055132	F179WT	4X7	10A	887838091628
711055134	F179WT	4X6	4	887838073525
711055135	F179WT	4X7	3	887838073532
711055136	F179WT	4X7	4	887838091635
711055152	F248	4	4	887838073549
711055154	F248	4	26D	887838073556
711055436	F179WT	4.5X7	3	
711055438	F179WT	4.5X7	P	887838091642
711055441	F179WT	4.5X7	26D	887838091659
711055444	F179WT	4.5X8	P	887838073594
711055447	F179WT	4.5X8	26D	887838073600
711057000	05-7000	3.5	STS	887838073624
711057005	05-7005	4	STS	887838073631
711057008	05-7008	4.5	STS	887838073648
711057015	05-7015	5	STS	887838073655
711057020	05-7020		3	887838073662
711057021	05-7021		26	887838073679
711057022	05-7022		4	887838091666
711057023	05-7023		26D	887838073686
711057030	05-7030		3	887838073693
711057031	05-7031		26	887838073709
711057032	05-7032		4	887838073716
711057033	05-7033		26D	887838073723
711057040	05-7040		3	887838073747
711057041	05-7041		26	887838073754
711057042	05-7042		4	887838073761
711057043	05-7043		26D	887838091673
711060008	FBB268	4.5	P	887838073778
711060010	FBB268	4.5	10	887838073785
711060011	FBB268	4.5	26D	887838073792
711060017	FBB268	5	P	887838073808
711060018	FBB268	5	26D	887838073815
711060021	FBB269	5	26D	887838073839
711060024	FBB268	5	10	887838073846
711060026	FBB278	5	P	887838091680
711060027	FBB278	5	26D	887838073853
711060038	FBB278	4.5	P	887838091697
711060041	FBB278	4.5	10	887838073860
711060042	FBB278	4.5	26D	887838073877
711060085	FBB269	5	P	887838091703
711060100	CEFBB179-66	4.5X4.5	26D	887838073884
711060101	CEFBB179-66	4.5X4.5	10	887838073891
711060102	CEFBB179-66	4.5X4.5	10A	887838073907
711060105	CEFBB179-66	5X4.5	26D	887838073914
711060106	CEFBB191-66	4.5X4.5	26D	887838073921
711060109	CEFBB191-66	4.5X4.5	3	887838091710
711060262	FBB138NRP	4.5	P	887838073938
711060263	FBB138	4.5	P	887838073945

EDP Number	Class Number	Size	Finish	UPC#
711060265	FBB138	4.5	26D	887838073952
711060266	FBB138NRP	4.5	26D	887838073969
711060330	CEFBB179-54	4.5X4	26D	887838087997
711060334	CEFBB179-54	4.5X4	P	887838073990
711060352	CEFBB179-54	4.5x4.5	26D	887838087539
711060353	FBB167	5	P	887838074058
711060363	FBB167	5	26D	887838074065
711060370	CEFBB179-54	4.5x4.5	P	887838074072
711060373	CEFBB179-54	4.5x4.5	10	887838074089
711060375	CEFBB179-54	4.5x4.5	10A	887838074096
711060376	CEFBB179-54	4.5x4.5	26	887838074102
711060378	CEFBB179-54	4.5x4.5	3	887838074126
711060382	CEFBB179-54	5x4.5	26D	887838074140
711061345	FBB168	4.5X4	15	887838074164
711061346	FBB168	4.5X4	26D	887838074171
711061348	FBB168NRP	4.5X4	15	887838074188
711061349	FBB168NRP	4.5X4	26D	887838088017
711061352	FBB168	4.5X4.5	15	887838074195
711061380	FBB168	5X4	26D	887838074201
711061426	FBB211 LH	5x4.5	26D	887838074225
711061436	FBB211 RH	5x4.5	26D	887838074249
711061514	FBB212 LH	5x4.5	P	
711061515	FBB212 LH	5x4.5	10	887838091727
711061516	FBB212 LH	5x4.5	26D	887838074263
711061524	FBB212 RH	5x4.5	P	887838074287
711061527	FBB212 RH	5x4.5	26D	887838074294
711061529	FBB212 RH	5x4.5	10	887838091734
711061564	FBB213 LH	5x4.5	P	887838074317
711061566	FBB213 LH	5x4.5	26D	887838074324
711061570	CEFBB168-54	4.5x4.5	26D	887838074331
711061573	FBB213 RH	5x4.5	P	887838074355
711061576	FBB213 RH	5x4.5	26D	887838074362
711061671	FBB168NRP	4.5X4.5	4	887838074454
711061672	FBB168	4.5X4.5	P	887838074461
711061673	FBB168	4.5X4.5	10	887838074478
711061675	FBB168	4.5X4.5	26	887838074485
711061676	FBB168	4.5X4.5	26D	887838088031
711061677	FBB168	4.5X4.5	10B	887838074492
711061678	FBB168	4.5X4.5	3	887838074508
711061679	FBB168	4.5X4.5	4	887838074515
711061680	FBB168	4.5X4.5	10A	887838074522
711061681	FBB168NRP	4.5X4.5	26	887838074539
711061682	FBB168NRP	4.5X4.5	P	887838074546
711061683	FBB168NRP	4.5X4.5	10	887838074553
711061684	FBB168NRP	4.5X4.5	26D	887838074560
711061685	FBB168NRP	4.5X4.5	10A	887838074577
711061687	FBB168NRP	4.5X4.5	3	887838074584
711061692	FBB168WT	4.5X5	26D	887838074607
711061699	FBB168WT	4.5X6	26D	887838074614
711061706	FBB168WT	4.5X7	26D	887838074621

## EDP Number to Class Number Cross Reference (cont.)

## Hinges & Door Accessories

EDP Number	Class Number	Size	Finish	UPC#
711061713	FBB168WT	4.5X8	26D	887838074638
711061728	FBB168	4.5X4.5	10BL	887838074683
711061738	FBB168NRP	5X4.5	4	887838074690
711061739	FBB168NRP	5X4.5	3	887838074706
711061740	FBB168NRP	5X4.5	26	887838074713
711061741	FBB168NRP	5X4.5	10	887838074720
711061742	FBB168	5X4.5	P	887838074737
711061743	FBB168	5X4.5	10	887838074744
711061746	FBB168	5X4.5	26D	887838074751
711061747	FBB168	5X4.5	26	887838074768
711061749	FBB168	5X4.5	10A	887838074775
711061752	FBB168	5X4.5	3	887838074782
711061753	FBB168	5X4.5	4	887838074799
711061769	FBB168NRP	5X4.5	P	887838074805
711061775	FBB168NRP	5X4.5	26D	887838088048
711061800	FBB168NRP	5X5	10	887838074812
711061801	FBB168NRP	5X5	10A	887838074829
711061802	FBB168NRP	5X5	3	887838074836
711061811	FBB168NRP	5X5	P	887838074843
711061812	FBB168	5X5	P	887838074850
711061813	FBB168	5X5	10	887838074867
711061816	FBB168	5X5	26D	887838074874
711061818	FBB168	5X5	10A	887838074881
711061820	FBB168	5X5	3	887838074898
711061828	FBB168NRP	5X5	26D	887838074904
711061832	FBB168	6X6	P	887838074928
711061835	FBB168	6X6	26D	887838074935
711061844	FBB168WT	5X7	26D	887838074959
711061875	FBB169	6	P	887838074973
711061878	FBB169	6	26D	887838091741
711061882	FBB168WT	5X8	26D	887838074980
711061981	FBB163NRP	4.5	P	887838074997
711061983	FBB163	4.5	P	887838075000
711061984	FBB163	4.5	26D	887838075017
711061994	FBB163NRP	4.5	26D	887838075024
711062139	F167NRP	4.5	26D	887838091758
711062143	FBB167	4.5	P	887838075048
711062145	FBB167	4.5	26D	887838088055
711062211	FBB169NRP	4.5	P	887838075055
711062212	FBB169	4.5	P	887838075062
711062215	FBB169	4.5	26D	887838075079
711062220	FBB169	5	26D	887838075086
711062301	FBB169NRP	5	P	887838075093
711062302	FBB169	5	P	887838075109
711062481	FBB171NRP	4.5	26D	887838075116
711062482	FBB171	4.5	26D	887838075123
711062483	FBB171	4.5	P	887838075130
711062512	FBB171	5	P	887838075154
711062515	FBB171	5	26D	887838075161
711062682	FBB173	4	P	887838075185

EDP Number	Class Number	Size	Finish	UPC#
711062722	FBB173	4.5	P	887838075192
711062723	FBB173	4.5	10	887838075208
711062726	FBB173	4.5	26D	887838088062
711062734	FBB173NRP	4.5	P	887838088079
711062735	FBB173NRP	4.5	26D	887838075215
711062743	FBB173NRP	5	P	887838075222
711062746	FBB173	5	P	887838075239
711062747	FBB173	5	26D	887838075246
711062907	FBB138	5	26D	887838075253
711062911	FBB138	5	P	887838091765
711063024	FBB138	6	26D	887838075291
711063411	FBB179NRP	4.5X4	10	887838088109
711063412	FBB179	4.5X4	P	887838075307
711063413	FBB179	4.5X4	10	887838088116
711063415	FBB179	4.5X4	26	887838088123
711063416	FBB179	4.5X4	26D	887838088130
711063419	FBB179	4.5X4	3	887838088147
711063421	FBB179NRP	4.5X4	15	887838075314
711063422	FBB179NRP	4.5X4	26	887838075321
711063423	FBB179NRP	4.5X4	3	887838075338
711063424	FBB179NRP	4.5X4	4	887838088154
711063429	FBB179	4.5X4	10A	887838088161
711063430	FBB179	4.5X4	14	887838091789
711063431	FBB179	4.5X4	15	887838075345
711063434	FBB179NRP	4.5X4	P	887838088178
711063435	FBB179NRP	4.5X4	10A	887838075352
711063436	FBB179NRP	4.5X4	26D	887838075369
711063437	FBB179	4.5X4	4	887838088185
711063818	FBB179	5X4.5	P	887838075406
711063821	FBB179	5X4.5	10	887838075413
711063823	FBB179	5X4.5	26D	887838075420
711063836	FBB179NRP	5X4.5	P	887838075444
711063837	FBB179NRP	5X4.5	26D	887838075451
711064343	FBB163	5	P	887838075475
711064344	FBB163	5	26D	887838075482
711064384	FBB163	6	P	887838075499
711064387	FBB163	6	26D	887838075505
711064490	FBB167NRP	4.5	26D	887838075512
711064491	FBB167NRP	4.5	P	887838088192
711064976	FBB168	6X5	P	887838075543
711064979	FBB168	6X5	26D	887838075550
711065121	FBB179WT	4X5	P	887838091796
711065122	FBB179WT	4X5	4	887838091802
711065126	FBB179WT	4X5	26D	887838075574
711065127	FBB179WT	4X5	3	887838075581
711065128	FBB179WT	4X5	10A	887838075598
711065129	FBB179WT	4X5	10B	887838075604
711065131	FBB179WT	4X6	P	887838075611
711065132	FBB179WT	4X6	4	887838075628
711065134	FBB179WT	4X6	10*	887838075635

## EDP Number to Class Number Cross Reference (cont.)

## Hinges & Door Accessories

EDP Number	Class Number	Size	Finish	UPC#
711065135	FBB179WT	4X6	10	887838091819
711065136	FBB179WT	4X6	26D	887838075642
711065137	FBB179WT	4X6	3	887838075659
711065138	FBB179WT	4X6	10A	887838091826
711065139	FBB179WT	4X6	10B	887838075666
711065140	FBB179WT	4X6	26	887838091833
711065146	FBB179WT	4X7	26D	887838075673
711065147	FBB179WT	4X7	3	887838075680
711065149	FBB179WT	4X7	10B	887838075697
711065151	FBB179WT	4X5	10BL	887838091840
711065152	FBB179WT	4X6	10BL	887838091857
711065153	FBB179WT	4X7	10BL	887838075703
711065510	FBB171NRP	4.5	P	887838075710
711067241	FBB179NRP	4X3.5	26D	887838075727
711067244	FBB179	4X3.5	26D	887838088208
711067245	FBB179	4X3.5	3	887838091864
711067265	FBB179NRP	4X4	10	887838075734
711067266	FBB179NRP	4X4	10A	887838075741
711067267	FBB179NRP	4X4	26	887838091871
711067268	FBB179NRP	4X4	3	887838075758
711067269	FBB179NRP	4X4	4	887838075765
711067270	FBB179NRP	4X4	P	887838075772
711067282	FBB179	4X4	P	887838075789
711067283	FBB179	4X4	F8	887838075796
711067582	FBB179NRP	4.5X4.5	4	887838075802
711067583	FBB179	4.5X4.5	10B	887838088215
711067585	FBB179	4.5X4.5	15	887838075819
711067882	FBB179	5X4	4	887838075833
711067885	FBB179	5X4	26D	887838075840
711067888	FBB179	5X4	P	887838075857
711068019	FBB179NRP	3.5X3	3	887838091888
711068095	FBB179	3.5X3.5	26	887838075871
711068096	FBB179	3.5X3.5	26D	887838088222
711068097	FBB179NRP	3.5X3.5	26D	887838075888
711068099	FBB179	3.5X3.5	3	887838075895
711068100	FBB179	3.5X3.5	4	887838075901
711068113	FBB179	6X5	P	887838075925
711068123	FBB179	6X6	P	887838088239
711068128	FBB179	6X6	26D	887838075932
711068133	FBB179WT	3.5X5	P	887838075949
711068134	FBB179WT	3.5X5	4	887838091895
711068136	FBB179WT	3.5X5	10*	887838091901
711068137	FBB179WT	3.5X5	10	887838091918
711068138	FBB179WT	3.5X5	26D	887838075956
711068139	FBB179WT	3.5X5	3	887838075963
711068140	FBB179WT	3.5X5	10A	887838075970
711068141	FBB179WT	3.5X5	10B	887838075987
711068143	FBB179WT	3.5X6	P	887838091925
711068144	FBB179WT	3.5X6	4	887838091932
711068148	FBB179WT	3.5X6	26D	887838091949

EDP Number	Class Number	Size	Finish	UPC#
711068149	FBB179WT	3.5X6	3	887838075994
711068151	FBB179WT	3.5X6	10B	887838091956
711068169	FBB179NRP	3.5X3.5	3	887838076090
711068201	FBB179	4X4	10	887838088246
711068202	FBB179	4X4	10A	887838076106
711068261	FBB179	4X4	26D	887838088253
711068277	FBB179	4X4	3	887838076113
711068278	FBB179	4X4	4	887838088260
711068279	FBB179	4X4	26	887838076120
711068281	FBB179NRP	4X4	26D	887838076137
711068287	RDFBBI79	4X4	26D	887838076151
711068293	RDFBBI79	3.5X3.5	3	887838076168
711068294	RDFBBI79	3.5X3.5	4	887838076175
711068295	RDFBBI79	3.5X3.5	26D	887838076182
711068381	FBB179	4.5X4.5	10	887838088277
711068383	FBB179	4.5X4.5	10A	887838088284
711068431	FBB179	4.5X4.5	P	887838076199
711068432	FBBK179	4.5X4.5	P	887838076205
711068436	FBB179	4.5X4.5	3	887838076212
711068438	FBB179	4.5X4.5	26	887838076229
711068439	FBB179NRP	4.5X4.5	26	887838076236
711068441	FBB179	4.5X4.5	26D	887838088291
711068444	FBB179NRP	4.5x4.5	26D	887838076243
711068446	FBB191NRP	4.5	32D	887838076250
711068618	FBB179	5X5	P	887838076267
711068622	FBB179	5X5	10A	887838076274
711068624	FBB179	5X5	26D	887838088307
711068625	FBB179	5X5	4	887838076281
711068627	FBB179	5X5	3	887838076298
711068631	FBB179NRP	5X5	26D	887838076304
711068632	FBB179NRP	5X5	P	887838076311
711068634	FBB179NRP	5X4.5	10A	887838076328
711068635	FBB179NRP	5X5	10A	887838076335
711068636	FBB179NRP	5X5	3	887838076342
711068637	FBB179NRP	5X5	4	887838076359
711068650	FBB179WT	5X7	P	887838091963
711068651	FBB179WT	5X7	4	887838091970
711068654	FBB179WT	5X7	26D	887838076366
711068655	FBB179WT	5X7	3	887838091987
711068656	FBB179WT	5X7	10A	887838076373
711068657	FBB179WT	5X7	10B	887838076380
711068660	FBB179WT	5X8	4	887838091994
711068663	FBB179WT	5X8	10	887838076397
711068664	FBB179WT	5X8	26D	887838076403
711068665	FBB179WT	5X8	3	887838092007
711068784	FBB179	4.5X4.5	4	887838076427
711068785	FBB179	4.5X4.5	10*	887838076434
711068845	FBB179ST	4.5X4.5	3	887838076441
711068846	FBB179BT	4.5X4.5	3	887838076458
711068847	FBB179NRP	4.5X4.5	3	887838076465

## EDP Number to Class Number Cross Reference (cont.)

## Hinges & Door Accessories

EDP Number	Class Number	Size	Finish	UPC#
711068849	FBBK179NRP	4.5X4.5	P	887838076472
711068850	FBB179NRP	4.5X4.5	10B	887838076489
711068851	FBB179NRP	4.5X4.5	P	887838076496
711068852	FBB179NRP	4.5X4.5	10	887838076502
711068853	FBB179NRP	4.5X4.5	26D	887838076519
711068856	HTFBB179	4.5X4.5	26D	887838076526
711068857	FBB179NRP	4.5X4.5	10A	887838076533
711068860	FBB248	4.5	26D	887838088314
711068863	FBB179WT	4.5X5	P	887838076571
711068864	FBB179WT	4.5X5	4	887838092014
711068867	FBB179WT	4.5X5	10	887838076588
711068868	FBB179WT	4.5X5	26D	887838076595
711068869	FBB179WT	4.5X5	3	887838076601
711068870	FBB179WT	4.5X5	10A	887838076618
711068871	FBB179WT	4.5X5	10B	887838076625
711068872	FBB179WT	4.5X5	26	887838076632
711068873	FBB179WT	4.5X6	P	887838076649
711068874	FBB179WT	4.5X6	4	887838076656
711068876	FBB179WT	4.5X6	10*	887838092021
711068877	FBB179WT	4.5X6	10	887838076663
711068878	FBB179WT	4.5X6	26D	887838088321
711068879	FBB179WT	4.5X6	3	887838076670
711068880	FBB179WT	4.5X6	10A	887838076687
711068881	FBB179WT	4.5X6	10B	887838076694
711068882	FBB179WT	4.5X6	26	887838076700
711068883	FBB179WT	4.5X7	P	887838076717
711068884	FBB179WT	4.5X7	4	887838092038
711068887	FBB179WT	4.5X7	10	887838092045
711068888	FBB179WT	4.5X7	26D	887838076724
711068891	FBB179WT	4.5X7	10B	887838076731
711068892	FBB179WT	4.5X7	26	887838092052
711068893	FBB179WT	4.5X8	P	887838076748
711068894	FBB179WT	4.5X8	4	887838076755
711068897	FBB179WT	4.5X8	10	887838076762
711068898	FBB179WT	4.5X8	26D	887838076779
711068899	FBB179WT	4.5X8	3	887838076786
711068900	FBB179WT	4.5X8	10A	887838092069
711068901	FBB179WT	4.5X8	10B	887838076793
711068950	FBB248	4.5	P	887838076809
711068956	FBB258	4.5	P	887838092076
711068959	FBB258	4.5	10	887838076816
711068960	FBB258	4.5	26D	887838088338
711069401	FBB264	5	26D	887838092083
711069403	FBB274	5	P	887838076847
711069410	FBB274	5	26D	887838076854
711069520	FBB266	5	26D	887838076878
711069836	FBB179	4X4	15	887838076892
711069837	FBB179	4X4	15A	887838076908
711069838	FBB179	4X4	5	887838076915
711069840	RDFBB179	4X4	26	887838076939

EDP Number	Class Number	Size	Finish	UPC#
711069841	RDFBB179	4X4	3	887838076946
711069842	RDFBB179	4X4	4	887838076953
711069843	FBB179	4.5X4.5	10BL	887838076960
711069844	FBB179	3.5X5	10BL	887838092090
711069849	FBB179WT	4.5X6	10BL	887838092106
711069850	FBB179WT	4.5X7	10BL	887838092113
711069851	FBB179WT	4.5X8	10BL	887838092120
711100005	JB-2R		2C	887838076991
711100300	DLS-1	5.75	26D	887838077004
711100302	DLS-1	5.75	10	887838077011
711100303	DLS-1	5.75	3	887838077028
711100340	DLS-2	5.75	26D	887838077035
711100342	DLS-2	5.75	10	887838077042
711100343	DLS-2	5.75	3	887838077059
711100403	ES-1		26D	887838088345
711100404	ES-1		26	887838077103
711100405	ES-1		10	887838077110
711100409	HB-1		26D	887838077134
711100411	ES-1		3	887838077141
711100438	651HD UL	6"8"	32D	88783811418
711100446	651HD UL	7"0"	32D	887838077165
711100453	651HD UL	7"2"	32D	88783811425
711100456	DAP-3		26D	887838088352
711100457	DAP-3		26	887838077189
711100458	DAP-3		10	887838077196
711100459	DAP-3		P	887838077202
711100460	DAP-3		3	887838077219
711100461	651HD UL	8"0"	32D	887838077226
711100479	651HD UL	10"0"	32D	887838077233
711100487	652HD UL	6"8"	32D	887838110589
711100495	652HD UL	7"0"	32D	887838077240
711100503	652HD UL	7"2"	32D	887838110596
711100511	652HD UL	8"0"	32D	887838110602
711100529	652HD UL	10"0"	32D	88783811517
711100537	653HD UL	6"8"	32D	88783811524
711100545	653HD UL	7"0"	32D	88783811531
711100552	653HD UL	7"2"	32D	88783811548
711100560	653HD UL	8"0"	32D	88783811555
711100578	653HD UL	10"0"	32D	88783811562
711124661	BP-1	4.5	P	887838077301
711124664	BP-1	4.5	26D	887838077318
711124671	BP-1	5	P	887838092137
711124672	BP-1	5	26D	887838077332
711127400	850	2X2	PS	887838088369
711127600	850	2.5X2.5	PS	887838077349
711127850	850	3X3	PS	887838088376
711128100	850	3.5X3.5	PS	887838077356
711128350	850	4X4	PS	887838077363
711128450	850	4.5X4.5	PS	887838077370
711128550	850	5X5	PS	887838088383

## EDP Number to Class Number Cross Reference (cont.)

## Hinges & Door Accessories

EDP Number	Class Number	Size	Finish	UPC#
71128750	850	6X6	PS	887838088390
71161060	641 UL	6'8"	P	887838077400
71161062	641 UL	7'0"	P	887838077417
71161063	641 UL	7'2"	P	887838092144
71161064	641 UL	8'0"	P	887838077424
71161065	641 UL	10'0"	P	887838077431
71161066	643 UL	6'8"	P	887838077448
71161067	643 UL	7'0"	P	887838092151
71161068	643 UL	7'2"	P	887838092168
71161069	643 UL	8'0"	P	887838077455
71161070	643 UL	10'0"	P	887838092175
71161072	644 UL	6'8"	P	887838092182
71161073	644 UL	7'0"	P	887838077462
71161074	644 UL	7'2"	P	887838092199
71161076	644 UL	10'0"	P	887838092205
71161077	645 UL	6'8"	P	887838092212
71161078	645 UL	7'0"	P	887838077479
71161079	645 UL	7'2"	P	887838092229
71161080	645 UL	8'0"	P	887838092236
71161082	645 UL	10'0"	P	887838092243
71161083	646 UL	6'8"	P	887838092250
71161084	646 UL	7'0"	P	887838077486
71161085	646 UL	7'2"	P	887838092267
71161086	646 UL	8'0"	P	887838092274
71161087	646 UL	10'0"	P	887838092281
71161088	647 UL	6'8"	P	887838077493
71161089	647 UL	7'0"	P	887838077509
71161090	647 UL	7'2"	P	887838092298
71161091	647 UL	8'0"	P	887838092304
71161092	647 UL	10'0"	P	887838077516
71161093	651 UL	6'8"	32D	887838077523
71161094	651 UL	7'0"	32D	887838077530
71161095	651 UL	7'2"	32D	887838077547
71161096	651 UL	8'0"	32D	887838077554
71161097	651 UL	10'0"	32D	887838077561
71161098	652 UL	6'8"	32D	887838077578
71161099	652 UL	7'0"	32D	887838077585
71161100	652 UL	7'2"	32D	887838077592
71161107	652 UL	8'0"	32D	887838077608
71161108	652 UL	10'0"	32D	887838077615
71161109	653 UL	6'8"	32D	887838077622
71161110	653 UL	7'0"	32D	887838077639
71161111	653 UL	7'2"	32D	887838077646
71161112	653 UL	8'0"	32D	887838077653
71161113	653 UL	10'0"	32D	887838092311
71161114	654 UL	6'8"	32D	887838092328
71161115	654 UL	7'0"	32D	887838077660
71161116	654 UL	7'2"	32D	887838092335
71161117	654 UL	8'0"	32D	887838092342
71161118	654 UL	10'0"	32D	887838092359

EDP Number	Class Number	Size	Finish	UPC#
71161119	655 UL	6'8"	32D	887838092366
71161120	655 UL	7'0"	32D	887838092373
71161121	655 UL	7'2"	32D	887838092380
71161122	655 UL	8'0"	32D	887838077677
71161123	655 UL	10'0"	32D	887838092397
71161124	656 UL	6'8"	32D	887838077684
71161125	656 UL	7'0"	32D	887838077691
71161126	656 UL	7'2"	32D	887838092403
71161127	656 UL	8'0"	32D	887838077707
71161128	656 UL	10'0"	32D	887838077714
71161129	657 UL	6'8"	32D	887838077721
71161130	657 UL	7'0"	32D	887838077738
71161131	657 UL	7'2"	32D	887838092410
71161132	657 UL	8'0"	32D	887838077745
71161133	657 UL	10'0"	32D	887838092427
71161137	651 UL-EPT2	7'0"	32D	
71161138	651 UL-EPT5LH	7'0"	32D	
71161139	651 UL-EPT5RH	7'0"	32D	
71161140	652 UL-EPT2LH	7'0"	32D	
71161141	652 UL-EPT2RH	7'0"	32D	
71161142	652 UL-EPT5LH	7'0"	32D	
71161143	652 UL-EPT5RH	7'0"	32D	
71161146	Steel Thru Bolts			887838077752
71162101	CE600		P	887838077769
711350043	327		26D	887838088953
711350158	340 RH		26D	887838078513
711350167	340 LH		26D	887838078520
711350170	340 RH		3	887838078537
711350172	340 LH		3	887838078544
711350219	342		26D	887838078551
711350220	342		3	887838078568
711350257	341 RH		3	887838078575
711350259	341 RH		26D	887838078582
711350267	341 LH		3	887838078599
711350268	341 LH		26D	887838078605
711384310	BB159		4	887838078636
71420407	2060R	4.5X4	4	887838088437
71420742	2060R	3.5X3.5	4	887838088444
71420744	2060R	3.5X3.5	P	887838079282
71420746	2060R	3.5X3.5	10	887838079299
71420748	2060R	3.5X3.5	10A	887838079305
71420749	2060R	3.5X3.5	3	887838079312
71420750	2060R	3.5X3.5	26D	887838088451
71420752	2060R	3.5X3.5	26	887838079336
71420754	RD2060R	3.5X3.5	4	887838079343
71420756	RD2060R	3.5X3.5	P	887838079350
71420762	RD2060R	3.5X3.5	26D	887838079367
71420764	RD2060R	3.5X3.5	3	887838079374
71420765	RD2060R	3.5X3.5	26	887838092434
71420766	RD2068R	3.5X3.5	4	887838079381
71420768	RD2068R	3.5X3.5	P	887838079398

## EDP Number to Class Number Cross Reference (cont.)

## Hinges & Door Accessories

EDP Number	Class Number	Size	Finish	UPC#
71420769	RD2068R BO	4X4	4	887838079404
71420774	RD2068R	35X35	26D	887838079411
71420775	RD2068R	35X35	3	887838079428
71420799	RD2060R BO	4X4	4	887838079435
71420803	RD2060R	4X4	26	887838079442
71420812	PDRD2068R	4X4	4	887838079459
71420814	PZRD2068R	4X4	PCW	887838079466
71420840	SDRD2068R	4X3-15/16"	ST4C	887838092441
71420841	SDRD2068R BO	4X3-15/16"	ST4C	887838079473
71420920	2060R	45X4	P	887838079480
71420921	2060R	45X4	10	887838079497
71420923	2060R	45X4	26D	887838088468
71420924	2060R	45X4	3	887838079503
71420925	2060R	45X4	10A	887838079510
71420926	2060R	45X4	26	887838088475
71420935	2060R	45X45	P	887838079527
71420936	2060R	45X45	4	887838088482
71420937	2060R	45X45	10	887838079534
71420939	2060R	45X45	26D	887838079541
71420940	2060R	45X45	3	887838079558
71420941	2060R	45X45	10A	887838079565
71420942	2060R	45X45	26	887838079572
71420982	RD2060R	45X4	26D	887838079589
71420992	RD2060R	45X45	26D	887838079596
71420994	RD2060R	45X45	3	887838092458
71421032	RD2068R	45X4	26D	887838079602
71421040	RD2068R	45X45	P	887838092465
71421042	RD2068R	45X45	26D	887838079619
71421044	RD2068R	45X45	3	887838092472
71422100	2060R	4X4	P	887838079626
71422101	RD2060R	4X4	ST4B	887838092489
71422102	2060R	4X4	4	887838079633
71422103	RD2060R	4X4	F8	887838079640
71422104	2060R	4X4	10	887838079657
71422105	RD2060R	4X4	10B	887838079664
71422106	2060R	4X4	26D	887838088499
71422108	2060R	4X4	10A	887838079671
71422110	2060R	4X4	3	887838079688
71422150	RD2060R	4X4	P	887838079718
71422151	RD2060R BO	4X4	ST4C	887838092496
71422152	RD2060R	4X4	4	887838079725
71422156	RD2060R	4X4	26D	887838079732
71422158	RD2060R	4X4	10A	887838079749
71422160	RD2060R	4X4	3	887838079756
71422200	RD2068R	4X4	P	887838079763
71422201	RD2068R BO	4X4	ST4C	887838092502
71422202	RD2068R	4X4	4	887838079770
71422204	RD2068R	4X4	10	887838079787
71422206	RD2068R	4X4	26D	887838079794
71422210	RD2068R	4X4	3	887838079800

EDP Number	Class Number	Size	Finish	UPC#
71422217	CGRD2068R	4X4	YC2	887838079831
71422224	BMRD2068R BO	4X4	ST4C	887838079848
71422225	BMRD2068R BO	4X4	PCW	887838079855
71422227	CGRD2068R	4X4	PCW	887838079862
71422229	TTRD2068R BO	4X4	PCW	887838079879
71422230	GHRD2068R	4X4	ST4C	887838092519
71422231	GHRD2068R	4X4	PCW	887838079886
71422237	PDRD2068R	4X4	26D	887838079893
71422310	2060R	35X35	32D	887838079909
71422311	2060R	35X35	32	887838092526
71422312	2060R	4X4	32D	887838079916
71422314	2060R	45X45	32D	887838079930
71422315	2060R	45X45	32	887838079947
71422316	RD2060R	35X35	32D	887838079954
71422317	RD2060R	35X35	32	887838079961
71422318	RD2060R	4X4	32D	887838079978
71422319	RD2060R	4X4	32	887838079985
71422320	RD2060R	45X45	32D	887838079992
71422321	RD2060R	45X45	32	887838092533
71422322	RD2068R	35X35	32D	887838080004
71422323	RD2068R	35X35	32	887838080011
71422324	RD2068R	4X4	32D	887838080028
71422325	RD2068R	4X4	32	887838080035
71422326	RD2068R	45X45	32D	887838080042
71422327	RD2068R	45X45	32	887838092540
71422328	2060R	45X4	32D	887838088505
71422329	2060R	45X4	32	887838092557
71422330	RD2060R	45X4	32D	887838092564
71422331	RD2060R	45X4	32	887838092571
71422332	RD2068R	45X4	32D	887838080059
71422333	RD2068R	45X4	32	887838092588
71440001	CECBI91-66	45X45	26D	887838080066
71440002	CECBI91-66	45X45	10	887838092595
71440003	CECBI91-66	45X45	10B	887838092601
71440004	CECBI91-66	45X45	3	887838092618
71440005	CECBI91-66	45X45	26	887838080073
71440006	CECBI91-66	5X45	26D	887838092625
71440077	CB191	4X4	32D	887838080080
71440114	CB191	45x45	32D	887838080103
71440116	CB191NRP	45X45	32D	887838080110
71440380	CECBI91-54	45X45	32D	887838080127
71440381	CECBI99-54	45X45	32D	887838080134
71440382	CECBI99-54	45X45	26D	887838080141
71441258	CB191NRP	45X4	26D	887838088512
71441865	CB223 LH	5x45	32D	887838080158
71441866	CB223 RH	5x45	32D	887838080165
71441867	CB212 LH	5x45	26D	887838080172
71441868	CB212 RH	5x45	26D	887838080189
71441869	CB213 LH	5x45	26D	887838080196
71441870	CB213 RH	5x45	26D	887838080202

## EDP Number to Class Number Cross Reference (cont.)

## Hinges & Door Accessories

EDP Number	Class Number	Size	Finish	UPC#
71441871	CB223 LH	5x4.5	26D	887838080219
71441872	CB223 RH	5x4.5	26D	887838080226
71443334	CB191	3.5X3.5	3	887838080233
71443350	CB191	3.5X3.5	10B	887838080240
71443362	CB191	4X4	26D	887838080257
71443364	CB191	4X4	3	887838080264
71443374	CB191	4X4	10B	887838080271
71443389	CB191	4.5X4.5	26	887838080288
71443392	CB191	4.5X4.5	26D	887838080295
71443393	CB191NRP	4.5X4.5	26D	887838080301
71443395	CB191NRP	4.5X4.5	3	887838080318
71443402	CB191	4.5X4.5	3	887838080325
71443403	CB191	4.5X4.5	4	887838080332
71443422	CB191	4.5X4.5	10	887838080349
71443435	CB191	4.5X4.5	10B	887838080356
71443437	CB191NRP	4.5X4.5	10	887838080363
71443438	CB191NRP	4.5X4.5	10B	887838080370
71443657	CB191	3.5X3.5	32D	887838080387
71443663	CB191	5X5	10B	887838092632
71443782	CB191	5X5	32D	887838080394
71444156	CB191	4.5X4	32D	887838080400
71444161	CB191NRP	4.5X4	32D	887838080417
71444340	CB191	5X4.5	32D	887838080424
71444350	CB191NRP	5X4.5	32D	887838080431
71444518	CB199	4.5X4	32D	887838088529
71444520	CB199NRP	4.5X4	32D	887838088536
71444783	CB199	4.5X4.5	32D	887838088543
71444786	CB199NRP	4.5X4.5	32D	887838080448
71444932	CB199	4.5X4.5	10	887838080455
71444938	CB199NRP	4.5X4.5	10	887838080462
71444940	CB199NRP	4.5X4.5	10B	887838080479
71444982	CB199NRP	5X4.5	32D	887838080486
71444992	CB199	4.5X4.5	26D	887838080493
71444998	CB199NRP	4.5X4.5	26D	887838088550
71445032	CB199	5X4.5	10B	887838080509
71445045	CB199NRP	5X4.5	26D	887838080516
71445072	CB199	5X4.5	32D	887838080523
71445073	CB199	5X4.5	26D	887838080530
71445111	CB199	5X5	10B	887838080547
71445125	CB199	5X5	32D	887838080554
71445490	IHTCB199 N/SRS	4.5X4.5	32D	887838088567
71446056	CB191	3.5X3.5	26D	887838080561
71447203	CB191	4.5X4	10B	887838080578
71447236	CB191	4.5X4	26D	887838080585
71447238	CB191	4.5X4	3	887838092649
71447255	CB191NRP	4.5X4	3	887838080608
71447266	CB191NRP	4.5X4	10B	887838080615
71447383	CB191	5X4.5	10B	887838080622
71450018	CB268	5"	26D	887838080639
71450024	CB268	5"	10	887838092656

EDP Number	Class Number	Size	Finish	UPC#
71450027	CB278	5	26D	887838080646
71450028	CECBI68-66	4.5X4.5	26D	887838080653
71450029	CECBI68-66	4.5X4.5	10	887838080660
71450030	CECBI68-66	4.5X4.5	10A	887838080677
71450031	CECBI68-66	4.5X4.5	3	887838080684
71450032	CECBI68-66	4.5X4.5	26	887838080691
71450033	CECBI68-66	5X4.5	26D	887838080707
71450034	CECBI79-66	4.5X4.5	26D	887838080714
71450035	CECBI79-66	4.5X4.5	10	887838080721
71450036	CECBI79-66	4.5X4.5	10A	887838080738
71450037	CECBI79-66	4.5X4.5	3	887838080745
71450038	CECBI79-66	4.5X4.5	26	887838092663
71450039	CECBI79-66	5X4.5	26D	887838080752
71450042	CB278	4.5	26D	887838080769
71450047	CB278	5	10	887838080776
71450055	CECBI79-12C			
71450056	CECBI79-12C			
71450057	CECBI79-12C			
71450058	CECBI79-12C			
71450090	CECBI99-12C	5" X 4.5"	10B	
71450091	CECBI99-12C	4.5" X 4.5"	32D	
71450092	CECBI99-12C	5" X 4.5"	32D	
71450097	CECBI68-12C	4.5" X 4.5"	26D	
71450098	CECBI68-12C	5" X 4.5"	26D	
71450100	CECBI79-12C	5" X 4"	26D	
71450101	CECBI91-12C	4.5" X 4.5"	32D	
71450330	CECBI79-54	4.5X4	26D	887838088963
71450331	CECBI79-54	4.5X4	26	887838080783
71450352	CECBI79-54	4.5X4.5	26D	887838088970
71450376	CECBI79-54	4.5X4.5	26	887838080790
71450377	CECBI79-54	4.5X4.5	4	887838080806
71451329	CB168NRP	4.5X4	26D	887838080813
71451345	CB168	4.5X4	15	887838088574
71451346	CB168	4.5X4	26D	887838080820
71451348	CB168NRP	4.5X4	15	887838088581
71451570	CECBI68-54	4.5X4.5	26D	887838080837
71451572	CECBI68-54	4.5X4	26D	887838080844
71451573	CECBI68-54	5X4.5	26D	887838080851
71451672	CB168	4.5X4.5	P	887838080868
71451673	CB168	4.5X4.5	10	887838080875
71451675	CB168	4.5X4.5	26	887838080882
71451676	CB168	4.5X4.5	26D	887838088598
71451678	CB168	4.5X4.5	3	887838080899
71451680	CB168	4.5X4.5	10A	887838080912
71451682	CB168NRP	4.5X4.5	P	887838080929
71451683	CB168NRP	4.5X4.5	10	887838080936
71451684	CB168NRP	4.5X4.5	26D	887838088604
71451685	CB168NRP	4.5X4.5	10A	887838080943
71451687	CB168NRP	4.5X4.5	3	887838080950
71451742	CB168	5X4.5	P	887838080967

## EDP Number to Class Number Cross Reference (cont.)

## Hinges & Door Accessories

EDP Number	Class Number	Size	Finish	UPC#
71451743	CBI68	5X4.5	10	887838080974
71451746	CBI68	5X4.5	26D	887838088611
71451749	CBI68	5X4.5	10A	887838080998
71451769	CBI68NRP	5X4.5	P	887838081018
71451775	CBI68NRP	5X4.5	26D	887838081025
71451811	CBI68NRP	5X5	P	887838092670
71451812	CBI68	5X5	P	887838081032
71451816	CBI68	5X5	26D	887838081049
71451828	CBI68NRP	5X5	26D	887838081063
71452483	CBI71	4.5	P	887838081094
71452722	CBI73	4.5	P	887838081100
71452726	CBI73	4.5	26D	887838081117
71453412	CBI79	4.5X4	P	887838081124
71453413	CBI79	4.5X4	10	887838081131
71453415	CBI79	4.5X4	26	887838088635
71453416	CBI79	4.5X4	26D	887838088642
71453419	CBI79	4.5X4	3	887838088659
71453421	CBI79NRP	4.5X4	15	887838081148
71453424	CBI79NRP	4.5X4	4	887838081155
71453429	CBI79	4.5X4	10A	887838081162
71453431	CBI79	4.5X4	15	887838081179
71453434	CBI79NRP	4.5X4	P	887838081186
71453436	CBI79NRP	4.5X4	26D	887838088666
71453437	CBI79	4.5X4	4	887838088673
71453818	CBI79	5X4.5	P	887838092687
71453823	CBI79	5X4.5	26D	887838081193
71453837	CBI79NRP	5X4.5	26D	887838081209
71455152	IHTCBI99 N/SRS	4.5X4.5	P	887838092694
71457282	CBI79	4X4	P	887838081223
71457283	CBI79	4X4	F8	887838081230
71457582	CBI79NRP	4.5X4.5	4	887838081247
71457583	CBI79	4.5X4.5	10B	887838081254
71457584	CBI79	4.5X4.5	10BL	887838081261
71457885	CBI79	5X4	26D	887838088680
71458095	CBI79	3.5X3.5	26	887838092700
71458096	CBI79	3.5X3.5	26D	887838081278
71458099	CBI79	3.5X3.5	3	887838081285
71458100	CBI79	3.5X3.5	4	887838081292
71458201	CBI79	4X4	10	887838081308
71458202	CBI79	4X4	10A	887838081315
71458261	CBI79	4X4	26D	887838081322
71458277	CBI79	4X4	3	887838081339
71458381	CBI79	4.5X4.5	10	887838081353
71458383	CBI79	4.5X4.5	10A	887838081360
71458431	CBI79	4.5X4.5	P	887838081377
71458432	CBK179	4.5X4.5	P	887838081384
71458436	CBI79	4.5X4.5	3	887838081391
71458438	CBI79	4.5X4.5	26	887838081407
71458439	CBI79NRP	4.5X4.5	26	887838081414
71458441	CBI79	4.5X4.5	26D	887838088697

EDP Number	Class Number	Size	Finish	UPC#
71458444	CBI79NRP	4.5X4.5	26D	887838081421
71458618	CBI79	5X5	P	887838081438
71458624	CBI79	5X5	26D	887838081445
71458784	CBI79	4.5X4.5	4	887838081452
71458847	CBI79NRP	4.5X4.5	3	887838081469
71458849	CBK179NRP	4.5X4.5	P	887838092717
71458850	CBI79NRP	4.5X4.5	10B	887838081476
71458851	CBI79NRP	4.5X4.5	P	887838081483
71458852	CBI79NRP	4.5X4.5	10	887838081490
71458853	CBI79NRP	4.5X4.5	26D	887838081506
71458856	HTCBI79	4.5X4.5	26D	887838081513
71458857	CBI79NRP	4.5X4.5	10A	887838081520
71458860	CB248	4.5	26D	887838081537
71459517	CB266	5	P	887838081551
71477751	663 UL	79"	AL	887838081568
71477752	663 UL	79"	DB	887838081575
71477753	663 UL	83"	AL	887838081582
71477754	663 UL	83"	DB	887838081599
71477755	663 UL	95"	AL	887838081605
71477756	663 UL	95"	DB	887838081612
71477757	663 UL	119"	AL	887838092724
71477758	663 UL	119"	DB	887838081629
71477759	662 UL	79"	AL	887838081636
71477760	662 UL	79"	DB	887838092731
71477761	662 UL	83"	AL	887838081643
71477762	662 UL	83"	DB	887838081650
71477763	662 UL	95"	AL	887838081667
71477764	662 UL	95"	DB	887838081674
71477765	662 UL	119"	AL	887838081681
71477766	662 UL	119"	DB	887838092748
71477767	661 UL	79"	AL	887838081698
71477768	661 UL	79"	DB	887838081704
71477769	661 UL	83"	AL	887838081711
71477770	661 UL	83"	DB	887838081728
71477771	661 UL	95"	AL	887838081735
71477772	661 UL	95"	DB	887838081742
71477773	661 UL	119"	AL	887838081759
71477774	661 UL	119"	DB	887838081766
71477775	664 UL	79"	AL	887838081773
71477776	664 UL	79"	DB	887838081780
71477777	664 UL	83"	AL	887838081797
71477778	664 UL	83"	DB	887838081803
71477779	664 UL	95"	AL	887838081810
71477780	664 UL	95"	DB	887838081827
71477781	664 UL	119"	AL	887838081834
71477782	664 UL	119"	DB	887838081841
71477784	665 UL	79"	AL	887838081858
71477785	665 UL	79"	DB	887838081865
71477786	665 UL	83"	AL	887838081872
71477787	665 UL	83"	DB	887838081889



## EDP Number to Class Number Cross Reference (cont.)

## Hinges & Door Accessories

EDP Number	Class Number	Size	Finish	UPC#
71477788	665 UL	95"	AL	887838081896
71477789	665 UL	95"	DB	887838092755
71477790	665 UL	119"	AL	887838092762
71477791	665 UL	119"	DB	887838092779
71477792	663HD UL	79"	AL	887838081902
71477793	663HD UL	79"	DB	887838081919
71477794	663HD UL	83"	AL	887838081926
71477795	663HD UL	83"	DB	887838081933
71477796	663HD UL	95"	AL	887838081940
71477797	663HD UL	95"	DB	887838092786
71477798	663HD UL	119"	AL	887838092793
71477799	663HD UL	119"	DB	887838081957
71477800	662HD UL	79"	AL	887838081964
71477801	662HD UL	79"	DB	887838081971
71477802	662HD UL	83"	AL	887838088987
71477803	662HD UL	83"	DB	887838081988
71477804	662HD UL	95"	AL	887838081995
71477805	662HD UL	95"	DB	887838082008
71477806	662HD UL	119"	AL	887838082015
71477807	662HD UL	119"	DB	887838082022
71477808	661HD UL	79"	AL	887838082039
71477809	661HD UL	79"	DB	887838082046
71477810	661HD UL	83"	AL	887838088994
71477811	661HD UL	83"	DB	887838082053
71477812	661HD UL	95"	AL	887838082060
71477813	661HD UL	95"	DB	887838082077
71477814	661HD UL	119"	AL	887838082084
71477815	661HD UL	119"	DB	887838082091
71477816	664HD UL	79"	AL	887838082107
71477817	664HD UL	79"	DB	887838082114
71477818	664HD UL	83"	AL	887838082121
71477819	664HD UL	83"	DB	887838082138
71477820	664HD UL	95"	AL	887838082145
71477821	664HD UL	95"	DB	887838082152
71477822	664HD UL	119"	AL	887838082169
71477823	664HD UL	119"	DB	887838082176
71477824	665HD UL	79"	AL	887838087515
71477825	665HD UL	79"	DB	887838082183
71477826	665HD UL	83"	AL	887838087522
71477827	665HD UL	83"	DB	887838089007
71477828	665HD UL	95"	AL	887838082190
71477829	665HD UL	95"	DB	887838082206
71477830	665HD UL	119"	AL	887838082213
71477831	665HD UL	119"	DB	887838092809
71477832	661 HD-EPT2	83"	AL	
71477833	661 HD-EPT5LH	83"	AL	
71477834	661 HD-EPT5RH	83"	AL	
71477835	662 HD- EPT2LH	83"	AL	
71477836	662 HD-EPT2RH	83"	AL	
71477837	662 HD-EPT5LH	83"	AL	

EDP Number	Class Number	Size	Finish	UPC#
71477838	662 HD-EPT5RH	83"	AL	
71477839	662 HD- EPT2LH	95"	AL	
71477840	662 HD-EPT2RH	95"	AL	
71477841	662 HD-EPT5LH	95"	AL	
71477842	662 HD-EPT5RH	95"	AL	
71477843	661 HD-EPT2LH	95"	AL	
71477844	661 HD-EPT2RH	95"	AL	
71477845	661 HD-EPT5LH	95"	AL	
71477846	661 HD-EPT5RH	95"	AL	
71477922	Replacement Covers	10'0"	AL	887838082220
71477923	Replacement Covers	10'0"	DB	887838082237
71570100	57-0100	12-24x1/2	26D	887838082947
71570102	57-0102	12-24x1/2	P	887838082954
71570113	57-0113	12x1-1/4	26D	887838082961
71570115	57-0115	12x1-1/4	P	887838082978
71570116	57-0116	12x1-1/4	10A	887838082985
71570117	57-0117	12x1-1/4	3	887838082992
71570119	Tek Screw Pack		AL	887838083005
71570120	Tek Screw Pack		DB	887838083012
71570121	Set of Through Bolts		AL	887838083029
71570122	Set of Through Bolts		DB	887838083036
71570123	Set of Through Bolts		AL	887838092816
71570124	Set of Through Bolts		DB	887838092823
71570201	57-0201	12x1-1/4	3	887838083043
71827162	2079	4.5x4.5	3	887838083128
71827170	2079	4.5x4.5	P	887838083135
71827188	2079	4.5x4.5	26D	887838083142
71834358	CB0701 RH	4.5x4.5	P	887838083166
71834366	CB0761 RH	4.5x4.5	32	887838083173
71834374	CB0761 RH	4.5x4.5	32D	887838083180
71834382	CB0701 LH	4.5x4.5	P	887838083197
71834390	CB0761 LH	4.5x4.5	32	887838083203
71834408	CB0761 LH	4.5x4.5	32D	887838083210
71839217	CECBI79-18	4.5X4.5	26D	887838083333
71839225	CECBI79-18	5X4.5	26D	887838083340
71839233	CECBI68-18	4.5x4.5	26D	887838083357
71839241	CECBI68-18	5x4.5	26D	887838083364
71839258	CECBI91-18	4.5X4.5	32D	887838083371
71839266	CECBI91-18	5X4.5	32D	887838083388
71839274	CECBI99-18	4.5X4.5	32D	887838083395
71839282	CECBI99-18	5x4.5	32D	887838083401
71925491	IHTCBI99 SRS	4.5X4.5	32D	887838084149
71925494	IHTCBI99 SRS	5x4.5	32D	887838084163
71925495	IHTCBI995 SRS	4.5x4.5	32D	887838088703
71925497	IHTCBI995 SRS	4.5x4.5	P	887838084170
71925498	IHTCBI995 N/SRS	4.5x4.5	32D	887838084187
71925499	IHTCBI995 N/SRS	4.5x4.5	P	887838084194
71925500	IHTCBI99 N/SRS	5x4.5	32D	887838084200
71925501	IHTCBI68 N/SRS	4.5x4.5	P	887838084217
71925509	IHTCBI68 N/SRS	5x4.5	P	887838084224

## EDP Number to Class Number Cross Reference (cont.)

## Hinges & Door Accessories

EDP Number	Class Number	Size	Finish	UPC#
711940001	1900R	3.5x3	26D	887838084231
711940002	1900R	3.5x3.5	P	887838092830
711940003	1900R	3.5x3.5	4	887838092847
711940004	1900R	3.5x3.5	10	887838084248
711940005	1900R	3.5x3.5	26D	887838084255
711940006	1900R	3.5x3.5	10A	887838092854
711940007	1900R	3.5x3.5	3	887838084262
711940008	1900R	3.5x3.5	26	887838084279
711940009	1900R	4x3.5	26D	887838084286
711940010	1900R	4x3.5	26	887838084293
711940011	1900R	4x4	P	887838092861
711940012	1900R	4x4	26D	887838084309
711940013	1900R	4x4	10A	887838092878
711940014	1900R	4x4	3	887838084316
711940015	1900R	4.5x4	P	887838092885
711940016	1900R	4.5x4	4	887838084323
711940017	1900R	4.5x4	10	887838084330
711940018	1900R	4.5x4	26D	887838084347
711940019	1900R	4.5x4	26	887838084354
711940020	1900R	4.5x4	3	887838092892
711940021	1900R	4.5x4	10A	887838092908
711940022	1900R	4.5x4	10B	887838084361
711940023	1900R	4.5x4.5	PCW	887838092915
711940024	1900R	4.5x4.5	4	887838084378
711940025	1900R	4.5x4.5	10	887838084385
711940026	1900R	4.5x4.5	26D	887838084392
711940027	1900R	4.5x4.5	26	887838084408
711940028	1900R	4.5x4.5	3	887838084415
711940029	1900R	4.5x4.5	10A	887838092922
711940030	1900R	4.5x4.5	10B	887838084422
711940031	1900R	5x4	26D	887838092939
711940032	1900R	5x4.5	26D	887838092946
711940033	1900R	5x5	P	887838092953
711940034	1900R NRP	3.5x3.5	26D	887838092960
711940035	1900R NRP	4.5x4	26D	887838084439
711940036	1900R NRP	4.5x4	3	887838092977
711940037	1900R NRP	4.5x4	10	887838092984
711940038	1900R NRP	4.5x4	10A	887838092991
711940039	1900R NRP	4.5x4	10B	887838093004
711940040	1900R NRP	4.5x4.5	PCW	887838093011
711940041	1900R NRP	4.5x4.5	P	887838093028
711940042	1900R NRP	4.5x4.5	10	887838093035
711940043	1900R NRP	4.5x4.5	26D	887838084446
711940044	1900R NRP	4.5x4.5	10B	887838093042
711940045	1900R NRP	4.5x4.5	26	887838084453
711940046	1900R NRP	4.5x4.5	10A	887838093059
711940047	1910R	4.5	P	887838093066
711940048	1910R	4.5	26D	887838084460
711940049	1920R	4.5	P	887838093073
711940052	1960R	3.5x3.5	10	887838093080

EDP Number	Class Number	Size	Finish	UPC#
711940053	1960R	3.5x3.5	26D	887838084491
711940054	1960R	3.5x3.5	3	887838093097
711940055	1960R	3.5x3.5	10B	887838093103
711940056	1960R	3.5x3.5	26	887838093110
711940057	1960R	4x4	26D	887838093127
711940058	1960R	4x4	3	887838093134
711940059	1960R	4x4	10B	887838093141
711940060	1960R	4x4	26	887838093158
711940061	1960R	4x4	32D	887838084507
711940062	1960R	4.5x4	26D	887838093165
711940063	1960R	4.5x4	32D	887838084514
711940064	1960R	4.5x4	3	887838093172
711940065	1960R	4.5x4	26	887838084521
711940066	1960R	4.5x4	10B	887838093189
711940067	1960R	4.5x4.5	26D	887838093196
711940068	1960R	4.5x4.5	3	887838093202
711940069	1960R	4.5x4.5	26	887838093219
711940070	1960R	4.5x4.5	10B	887838084538
711940071	1960R	4.5x4.5	32D	887838084545
711940072	1960R	5x4	26D	887838093226
711940073	1960R NRP	3.5x3.5	10	887838093233
711940074	1960R NRP	3.5x3.5	26	887838093240
711940075	1960R NRP	3.5x3.5	10B	887838093257
711940076	1960R NRP	3.5x3.5	32D	887838093264
711940080	1960R NRP	4.5x4	26D	887838093271
711940081	1960R NRP	4.5x4	32D	887838084552
711940082	1960R NRP	4.5x4	3	887838093288
711940083	1960R NRP	4.5x4	26	887838093295
711940084	1960R NRP	4.5x4	10B	887838093301
711940085	1960R NRP	4.5x4.5	26D	887838093318
711940086	1960R NRP	4.5x4.5	3	887838093325
711940087	1960R NRP	4.5x4.5	26	887838093332
711940088	CB1900R	3.5X3.5	4	887838084569
711940089	CB1900R	3.5X3.5	LA	887838093349
711940090	CB1900R	3.5X3.5	3	887838084576
711940091	CB1900R	3.5X3.5	26D	887838088710
711940092	CB1900R	3.5X3.5	10A	887838084583
711940093	CB1900R	3.5X3.5	26	887838093356
711940094	CB1900R	4X4	26D	887838084590
711940095	CB1900R	4X4	3	887838084606
711940096	CB1900R	4.5X4	P	887838084613
711940097	CB1900R	4.5X4	4	887838084620
711940098	CB1900R	4.5X4	10	887838088727
711940099	CB1900R	4.5X4	26D	887838088734
711940100	CB1900R	4.5X4	26	887838084637
711940101	CB1900R	4.5X4	3	887838084644
711940102	CB1900R	4.5X4	10A	887838084651
711940103	CB1900R	4.5X4	10B	887838088741
711940104	CB1900R	4.5X4	15	887838084668
711940105	CB1900R	4.5X4.5	P	887838084675

## EDP Number to Class Number Cross Reference (cont.)

## Hinges & Door Accessories

EDP Number	Class Number	Size	Finish	UPC#
711940106	CB1900R	4.5X4.5	4	887838084682
711940107	CB1900R	4.5X4.5	10	887838084699
711940108	CB1900R	4.5X4.5	26D	887838084705
711940109	CB1900R	4.5X4.5	26	887838084712
711940110	CB1900R	4.5X4.5	3	887838084729
711940111	CB1900R	4.5X4.5	10A	887838084736
711940112	CB1900R	4.5X4.5	10B	887838084743
711940113	CB1900R	4.5X4.5	15	887838084750
711940114	CB1900R	5X4	P	887838084767
711940115	CB1900R	5X4	26D	887838088758
711940116	CB1900R	5X4.5	P	887838093363
711940117	CB1900R	5X4.5	26D	887838088765
711940118	CB1900R	5X4.5	26	887838084774
711940119	CB1900R	5X4.5	3	887838093370
711940120	CB1900R	5X4.5	10B	887838084781
711940121	CB1900R	5X5	10	
711940122	CB1900R	5X5	4	887838093387
711940123	CB1900R	5X5	26D	887838084798
711940124	CB1900R	5X5	10A	887838093394
711940125	CB1900R	5X5	26	887838084804
711940126	CB1900R NRP	4X4	26D	887838084811
711940127	CB1900R NRP	4X4	3	887838093400
711940128	CB1900R NRP	4.5X4	P	887838084828
711940129	CB1900R NRP	4.5X4	4	887838084835
711940130	CB1900R NRP	4.5X4	15	887838084842
711940131	CB1900R NRP	4.5X4	10	887838084859
711940132	CB1900R NRP	4.5X4	26D	887838084866
711940133	CB1900R NRP	4.5X4	10A	887838084873
711940134	CB1900R NRP	4.5X4	26	887838084880
711940135	CB1900R NRP	4.5X4	3	887838084897
711940136	CB1900R NRP	4.5X4.5	P	887838084903
711940137	CB1900R NRP	4.5X4.5	4	887838084910
711940138	CB1900R NRP	4.5X4.5	10	887838084927
711940139	CB1900R NRP	4.5X4.5	26D	887838088772
711940140	CB1900R NRP	4.5X4.5	10B	887838084934
711940141	CB1900R NRP	4.5X4.5	26	887838084941
711940142	CB1900R NRP	4.5X4.5	10A	887838084958
711940143	CB1900R NRP	4.5X4.5	3	887838093417
711940144	CB1900R NRP	4.5X4.5	15	887838084965
711940145	CB1900R NRP	5X4.5	26D	887838084972
711940146	CB1900R NRP	5X4.5	26	887838093424
711940147	CB1900R NRP	5X4.5	P	887838093431
711940148	CB1900R NRP	5X5	26D	887838084989
711940149	CB1900R NRP	5X5	10A	887838093448
711940150	CB1900R NRP	5X5	26	887838093455
711940151	CBK1900R	4.5x4.5	P	887838093462
711940152	CBK1900R NRP	4.5x4.5	P	887838093479
711940153	HTCB1900R	4.5x4	26D	887838084996
711940154	HTCB1900R	4.5x4.5	26D	887838085009
711940157	CB1910R	4	P	887838085016

EDP Number	Class Number	Size	Finish	UPC#
711940158	CB1910R	4.5	P	887838085023
711940159	CB1910R	4.5	26D	887838085030
711940160	CB1910R	5	26D	887838085047
711940161	CB1920R	4.5	P	887838093486
711940162	CB1920R	4.5	26D	887838085054
711940163	CB1920R	5	P	887838085061
711940164	CB1930R	4.5	P	887838093493
711940165	CB1930R	5	26D	887838093509
711940166	CB1946R	4.5	26D	887838085078
711940167	CB1947R	4.5	26D	887838085085
711940168	CB1947R NRP	4.5	26D	887838085092
711940169	CB1960R	3.5x3.5	26D	887838085108
711940170	CB1960R	3.5x3.5	10	887838093516
711940171	CB1960R	3.5x3.5	10B	887838093523
711940172	CB1960R	3.5x3.5	32D	887838085115
711940173	CB1960R	4x4	26D	887838085122
711940174	CB1960R	4x4	3	887838093530
711940175	CB1960R	4x4	10B	887838085139
711940176	CB1960R	4x4	32D	887838085146
711940177	CB1960R	4.5x4	26D	887838085153
711940178	CB1960R	4.5x4	10B	887838085160
711940179	CB1960R	4.5x4	26	887838085177
711940180	CB1960R	4.5x4	3	887838093547
711940181	CB1960R	4.5x4	32D	887838088789
711940182	CB1960R	4.5x4	32	887838085184
711940183	CB1960R	4.5x4	10	887838085191
711940184	CB1960R	4.5x4	4	887838085207
711940185	CB1960R	4.5x4.5	4	887838085214
711940186	CB1960R	4.5X4.5	10	887838085221
711940187	CB1960R	4.5x4.5	26D	887838085238
711940188	CB1960R	4.5x4.5	26	887838085245
711940189	CB1960R	4.5x4.5	3	887838085252
711940190	CB1960R	4.5x4.5	10B	887838085269
711940191	CB1960R	4.5X4.5	32D	887838085276
711940192	CB1960R	5x4	26D	887838085283
711940193	CB1960R	5x4.5	10B	887838093554
711940194	CB1960R	5x4.5	3	887838093561
711940195	CB1960R	5x4.5	32D	887838085290
711940196	CB1960R	5x5	3	887838093578
711940197	CB1960R	5x5	26D	887838085306
711940198	CB1960R	5x5	26	887838093585
711940199	CB1960R	5x5	10B	887838093592
711940200	CB1960R	5x5	32D	887838085313
711940201	CB1960R NRP	3.5x3.5	10B	887838085320
711940202	CB1960R NRP	3.5x3.5	32D	887838085337
711940203	CB1960R NRP	3.5x3.5	26D	887838085344
711940204	CB1960R NRP	4.5x4	26D	887838085351
711940205	CB1960R NRP	4.5x4	10B	887838085368
711940206	CB1960R NRP	4.5x4	3	887838085375
711940207	CB1960R NRP	4.5x4	26	887838085382

## EDP Number to Class Number Cross Reference (cont.)

## Hinges & Door Accessories

EDP Number	Class Number	Size	Finish	UPC#
711940208	CB1960RNP	4.5x4	32D	887838088796
711940209	CB1960RNP	4.5x4	10	887838085399
711940210	CB1960RNP	4.5x4	4	887838093608
711940211	CB1960RNP	4.5x4.5	4	887838085405
711940212	CB1960RNP	4.5x4.5	10	887838085412
711940213	CB1960RNP	4.5x4.5	26D	887838088802
711940214	CB1960RNP	4.5x4.5	3	887838093615
711940215	CB1960RNP	4.5x4.5	10B	887838085429
711940216	CB1960RNP	4.5x4.5	32D	887838085436
711940217	CB1960RNP	4.5x4.5	32	887838085443
711940218	CB1960RNP	5x4.5	3	887838093622
711940219	CB1960RNP	5x4.5	10B	887838085450
711940220	CB1960RNP	5x4.5	32D	887838085467
711940221	CB1960RNP	5x5	26D	887838093639
711940222	CB1960RNP	5x5	26	887838093646
711940223	CB1960RNP	5x5	10B	887838085474
711940224	CB1960RNP	5x5	32D	887838085481
711940225	CB1970R	4.5	26D	887838085498
711940226	CB1970R	4.5	10B	887838093653
711940227	CB1970R	4.5	32D	887838085504
711940228	CB1970R	5	26D	887838093660
711940229	CB1970R	5	32D	887838093677
711940230	CB1980R	4.5	26D	887838093684
711940231	CB1980R	4.5	10B	887838093691
711940232	CB1980R	4.5	32D	887838093707
711940233	CB1980R	5	32D	887838093714
711940234	CB1980R	5	10B	887838093721
711940235	CB1990R	4.5	26D	887838085511
711940236	CB1990R	4.5	10B	887838093738
711940237	CB1990R	4.5	32D	887838093745
711940238	CB1990R	5	32D	887838093752
711940239	CB1990R	5	10B	887838093769
711940240	CECB1900R-54-LH	4.5x4	26D	887838089038
711940241	CECB1900R-54-LH	4.5x4	P	887838093776
711940242	CECB1900R-54-LH	4.5x4	3	887838085528
711940243	CECB1900R-54-LH	4.5x4	26	887838093783
711940244	CECB1900R-54-LH	4.5x4	10A	887838093790
711940245	CECB1900R-54-LH	4.5x4	4	887838085535
711940246	CECB1900R-54-LH	4.5x4	10	887838093806
711940247	CECB1900R-54-LH	4.5x4.5	26D	887838085542
711940248	CECB1900R-54-LH	4.5x4.5	P	887838093813
711940249	CECB1900R-54-LH	4.5x4.5	3	887838085559
711940250	CECB1900R-54-LH	4.5x4.5	26	887838085566
711940251	CECB1900R-54-LH	4.5x4.5	10A	887838085573
711940252	CECB1900R-54-LH	4.5x4.5	4	887838085580
711940253	CECB1900R-54-LH	4.5x4.5	10	887838085597
711940254	CECB1900R-56-LH	4.5x4	26D	887838085603
711940255	CECB1900R-56-LH	4.5x4	P	887838093820
711940256	CECB1900R-56-LH	4.5x4	3	887838093837
711940257	CECB1900R-56-LH	4.5x4	26	887838093844

EDP Number	Class Number	Size	Finish	UPC#
711940258	CECB1900R-56-LH	4.5x4	10A	887838093851
711940259	CECB1900R-56-LH	4.5x4	4	887838093868
711940260	CECB1900R-56-LH	4.5x4	10	887838093875
711940261	CECB1900R-56-LH	4.5x4.5	26D	887838085610
711940262	CECB1900R-56-LH	4.5x4.5	P	887838093882
711940263	CECB1900R-56-LH	4.5x4.5	3	887838093899
711940264	CECB1900R-56-LH	4.5x4.5	26	887838093905
711940265	CECB1900R-56-LH	4.5x4.5	10A	887838093912
711940266	CECB1900R-56-LH	4.5x4.5	4	887838093929
711940267	CECB1900R-56-LH	4.5x4.5	10	887838085627
711940268	CECB1900R-58-LH	4.5x4	26D	887838085634
711940269	CECB1900R-58-LH	4.5x4	P	887838093936
711940270	CECB1900R-58-LH	4.5x4	3	887838093943
711940271	CECB1900R-58-LH	4.5x4	26	887838093950
711940272	CECB1900R-58-LH	4.5x4	10A	887838093967
711940273	CECB1900R-58-LH	4.5x4	4	887838093974
711940274	CECB1900R-58-LH	4.5x4	10	887838093981
711940275	CECB1900R-58-LH	4.5x4.5	26D	887838085641
711940276	CECB1900R-58-LH	4.5x4.5	P	887838093998
711940277	CECB1900R-58-LH	4.5x4.5	3	887838094001
711940278	CECB1900R-58-LH	4.5x4.5	26	887838085658
711940279	CECB1900R-58-LH	4.5x4.5	10A	887838085665
711940280	CECB1900R-58-LH	4.5x4.5	4	887838094018
711940281	CECB1900R-58-LH	4.5x4.5	10	887838094025
711940282	CECB1900R-66-LH	4.5x4	26D	887838085672
711940283	CECB1900R-66-LH	4.5x4	P	887838094032
711940284	CECB1900R-66-LH	4.5x4	3	887838094049
711940285	CECB1900R-66-LH	4.5x4	26	887838094056
711940286	CECB1900R-66-LH	4.5x4	10A	887838094063
711940287	CECB1900R-66-LH	4.5x4	4	887838094070
711940288	CECB1900R-66-LH	4.5x4	10	887838094087
711940289	CECB1900R-66-LH	4.5x4.5	26D	887838085689
711940290	CECB1900R-66-LH	4.5x4.5	P	887838094094
711940291	CECB1900R-66-LH	4.5x4.5	3	887838094100
711940292	CECB1900R-66-LH	4.5x4.5	26	887838094117
711940293	CECB1900R-66-LH	4.5x4.5	10A	887838094124
711940294	CECB1900R-66-LH	4.5x4.5	4	887838094131
711940295	CECB1900R-66-LH	4.5x4.5	10	887838094148
711940296	CECB1900R-54-RH	4.5x4	26D	887838089045
711940297	CECB1900R-54-RH	4.5x4	P	887838094155
711940298	CECB1900R-54-RH	4.5x4	3	887838085696
711940299	CECB1900R-54-RH	4.5x4	26	887838094162
711940300	CECB1900R-54-RH	4.5x4	10A	887838094179
711940301	CECB1900R-54-RH	4.5x4	4	887838094186
711940302	CECB1900R-54-RH	4.5x4	10	887838094193
711940303	CECB1900R-54-RH	4.5x4.5	26D	887838085702
711940304	CECB1900R-54-RH	4.5x4.5	P	887838094209
711940305	CECB1900R-54-RH	4.5x4.5	3	887838085719
711940306	CECB1900R-54-RH	4.5x4.5	26	887838085726
711940307	CECB1900R-54-RH	4.5x4.5	10A	887838085733

## EDP Number to Class Number Cross Reference (cont.)

## Hinges & Door Accessories

EDP Number	Class Number	Size	Finish	UPC#
711940308	CECB1900R-54-RH	4.5x4.5	4	887838094216
711940309	CECB1900R-54-RH	4.5x4.5	10	887838085740
711940310	CECB1900R-56-RH	4.5x4	26D	887838085757
711940311	CECB1900R-56-RH	4.5x4	P	887838094223
711940312	CECB1900R-56-RH	4.5x4	3	887838094230
711940313	CECB1900R-56-RH	4.5x4	26	887838094247
711940314	CECB1900R-56-RH	4.5x4	10A	887838094254
711940315	CECB1900R-56-RH	4.5x4	4	887838094261
711940316	CECB1900R-56-RH	4.5x4	10	887838094278
711940317	CECB1900R-56-RH	4.5x4.5	26D	887838085764
711940318	CECB1900R-56-RH	4.5x4.5	P	887838094285
711940319	CECB1900R-56-RH	4.5x4.5	3	887838094292
711940320	CECB1900R-56-RH	4.5x4.5	26	887838094308
711940321	CECB1900R-56-RH	4.5x4.5	10A	887838094315
711940322	CECB1900R-56-RH	4.5x4.5	4	887838094322
711940323	CECB1900R-56-RH	4.5x4.5	10	887838085771
711940324	CECB1900R-58-RH	4.5x4	26D	887838085788
711940325	CECB1900R-58-RH	4.5x4	P	887838094339
711940326	CECB1900R-58-RH	4.5x4	3	887838094346
711940327	CECB1900R-58-RH	4.5x4	26	887838094353
711940328	CECB1900R-58-RH	4.5x4	10A	887838085795
711940329	CECB1900R-58-RH	4.5x4	4	887838094360
711940330	CECB1900R-58-RH	4.5x4	10	887838094377
711940331	CECB1900R-58-RH	4.5x4.5	26D	887838085801
711940332	CECB1900R-58-RH	4.5x4.5	P	887838094384
711940333	CECB1900R-58-RH	4.5x4.5	3	887838094391
711940334	CECB1900R-58-RH	4.5x4.5	26	887838094407
711940335	CECB1900R-58-RH	4.5x4.5	10A	887838085818
711940336	CECB1900R-58-RH	4.5x4.5	4	887838094414
711940337	CECB1900R-58-RH	4.5x4.5	10	887838094421
711940338	CECB1900R-58-RH	4.5x4	26D	887838085825
711940339	CECB1900R-66-RH	4.5x4	P	887838094438
711940340	CECB1900R-66-RH	4.5x4	3	887838094445
711940341	CECB1900R-66-RH	4.5x4	26	887838094452
711940342	CECB1900R-66-RH	4.5x4	10A	887838094469
711940343	CECB1900R-66-RH	4.5x4	4	887838094476
711940344	CECB1900R-66-RH	4.5x4	10	887838094483
711940345	CECB1900R-66-RH	4.5x4.5	26D	887838085832
711940346	CECB1900R-66-RH	4.5x4.5	P	887838094490
711940347	CECB1900R-66-RH	4.5x4.5	3	887838094506
711940348	CECB1900R-66-RH	4.5x4.5	26	887838094513
711940349	CECB1900R-66-RH	4.5x4.5	10A	887838094520
711940350	CECB1900R-66-RH	4.5x4.5	4	887838094537
711940351	CECB1900R-66-RH	4.5x4.5	10	887838094544
711950001	CB1901R	4.5x4	26D	887838088819
711950002	CB1901R	4.5x4	15	887838085849
711950003	CB1901R	4.5x4	10	887838085856
711950004	CB1901R	4.5x4	26	887838085863
711950005	CB1901R	4.5x4	10A	887838085870
711950006	CB1901R	4.5x4	3	887838085887

EDP Number	Class Number	Size	Finish	UPC#
711950007	CB1901R	4.5x4	10B	887838085894
711950008	CB1901R	4.5x4.5	P	887838085900
711950009	CB1901R	4.5x4.5	10	887838085917
711950010	CB1901R	4.5x4.5	26D	887838085924
711950011	CB1901R	4.5x4.5	26	887838085931
711950012	CB1901R	4.5x4.5	10A	887838085948
711950013	CB1901R	4.5x4.5	3	887838085955
711950014	CB1901R	4.5x4.5	15	887838085962
711950015	CB1901R	5x4.5	P	887838085979
711950016	CB1901R	5x4.5	10	887838085986
711950017	CB1901R	5x4.5	26D	887838085993
711950018	CB1901R	5x4.5	10A	887838086006
711950019	CB1901R	5x4.5	26	887838086013
711950020	CB1901R	5x5	P	887838094551
711950021	CB1901R	5x5	26D	887838086020
711950022	CB1901R	5x5	10	887838094568
711950023	CB1901R	5x5	10A	887838086037
711950024	CB1901R	6x5	26D	887838086044
711950025	CB1901R NRP	4.5x4	26D	887838088826
711950026	CB1901R NRP	4.5x4	15	887838086051
711950027	CB1901R NRP	4.5x4	10	887838086068
711950028	CB1901R NRP	4.5x4	10A	887838094575
711950029	CB1901R NRP	4.5x4	10B	887838086075
711950030	CB1901R NRP	4.5x4	26	887838086082
711950031	CB1901R NRP	4.5x4	3	887838086099
711950032	CB1901R NRP	4.5x4.5	P	887838086105
711950033	CB1901R NRP	4.5x4.5	10	887838086112
711950034	CB1901R NRP	4.5x4.5	26D	887838086129
711950035	CB1901R NRP	4.5x4.5	10A	887838086136
711950036	CB1901R NRP	4.5x4.5	26	887838086143
711950037	CB1901R NRP	4.5x4.5	3	887838086150
711950038	CB1901R NRP	4.5x4.5	15	887838086167
711950039	CB1901R NRP	5x4.5	P	887838086174
711950040	CB1901R NRP	5x4.5	26D	887838086181
711950043	CB1901R NRP	5x5	26D	887838086204
711950044	CB1901R NRP	5x5	10	887838094582
711950045	CB1901R NRP	5x5	10A	887838094599
711950046	CB1901R NRP	5x5	P	887838094605
711950047	IHTCB1901R	4.5x4.5	P	887838086211
711950049	IHTCB1901R	5x4.5	P	887838086228
711950050	CB1907R LH	5x4.5	26D	887838086235
711950051	CB1907R RH	5x4.5	26D	887838086242
711950052	CB1908R LH	5x4.5	P	887838094612
711950053	CB1908R LH	5x4.5	26D	887838086259
711950054	CB1908R RH	5x4.5	P	887838094629
711950055	CB1908R RH	5x4.5	26D	887838086266
711950056	CB1909R LH	5x4.5	P	887838086273
711950057	CB1909R LH	5x4.5	26D	887838086280
711950058	CB1909R RH	5x4.5	P	887838086297
711950059	CB1909R RH	5x4.5	26D	887838086303

## EDP Number to Class Number Cross Reference (cont.)

## Hinges & Door Accessories

EDP Number	Class Number	Size	Finish	UPC#
711950062	CB1911R	4.5	26D	887838086310
711950063	CB1911R	5	26D	887838086327
711950064	CB1911R	6	P	887838094636
711950065	CB1921R	4.5	P	887838094643
711950066	CB1921R	4.5	26D	887838086334
711950067	CB1921R	5	P	887838094650
711950068	CB1921R	6	26D	887838094667
711950069	CB1931R	4.5	P	887838086341
711950070	CB1931R	5	P	887838094674
711950071	CB1931R	6	P	887838094681
711950072	CB1941R	5	26D	887838086358
711950073	CB1942R	5	P	887838094698
711950074	CB1948R	5	26D	887838086365
711950075	CB1948R	5	P	887838094704
711950076	CB1948R	5	10A	887838094711
711950077	CB1948R	5	10	887838094728
711950078	CB1948R NRP	5	26D	887838086372
711950079	CB1948R NRP	5	10	887838094735
711950080	CB1948R NRP	5	10A	887838094742
711950081	CB1949R	4.5	26D	887838086389
711950082	CB1949R	5	26D	887838086396
711950083	CB1949R	5	10	887838094759
711950084	CB1949R NRP	5	26D	887838086402
711950085	CB1949R NRP	5	10	887838086419
711950086	CB1951R	5	P	887838086426
711950087	CB1951R	5	26D	887838094766
711950088	CB1951R NRP	5	P	887838094773
711950089	CB1959R	5	26D	887838086433
711950090	CB1959R	5	P	887838094780
711950091	CB1961R	4.5x4	32D	887838086440
711950092	CB1961R	4.5x4	10B	887838086457
711950093	CB1961R	4.5x4	26D	887838086464
711950094	CB1961R	4.5x4	26	887838094797
711950095	CB1961R	4.5x4	3	887838086471
711950096	CB1961R	4.5x4	4	887838094803
711950097	CB1961R	4.5x4	10	887838094810
711950098	CB1961R	4.5x4.5	10	887838086488
711950099	CB1961R	4.5x4.5	26D	887838088833
711950100	CB1961R	4.5x4.5	10B	887838086495
711950101	CB1961R	4.5x4.5	26	887838086501
711950102	CB1961R	4.5x4.5	32D	887838086518
711950103	CB1961R	4.5x4.5	32	887838086525
711950104	CB1961R	5x4.5	26D	887838086532
711950105	CB1961R	5x4.5	10B	887838086549
711950106	CB1961R	5x4.5	32D	887838086556
711950107	CB1961R	5x4.5	32	887838094827
711950108	CB1961R	5x5	26D	887838086563
711950109	CB1961R	5x5	10B	887838086570
711950110	CB1961R	5x5	32D	887838086587
711950111	CB1961R	6x4.5	26D	887838086594

EDP Number	Class Number	Size	Finish	UPC#
711950112	CB1961R	6x5	26D	887838094834
711950113	CB1961RNRP	4.5x4	32D	887838086600
711950114	CB1961RNRP	4.5x4	10B	887838086617
711950115	CB1961RNRP	4.5x4	26D	887838086624
711950116	CB1961RNRP	4.5x4	26	887838094841
711950117	CB1961RNRP	4.5x4	3	887838094858
711950118	CB1961RNRP	4.5x4	4	887838086631
711950119	CB1961RNRP	4.5x4	10	887838086648
711950120	CB1961RNRP	4.5x4.5	10	887838086655
711950121	CB1961RNRP	4.5x4.5	26D	887838087669
711950122	CB1961RNRP	4.5x4.5	10B	887838086662
711950123	CB1961RNRP	4.5x4.5	26	887838094865
711950124	CB1961RNRP	4.5x4.5	32D	887838086679
711950125	CB1961RNRP	4.5x4.5	32	887838094872
711950126	CB1961RNRP	5x4.5	26D	887838086686
711950127	CB1961RNRP	5x4.5	10B	887838086693
711950128	CB1961RNRP	5x4.5	32D	887838086709
711950129	CB1961RNRP	5x4.5	32	887838086716
711950130	CB1961RNRP	5x5	26D	887838086723
711950131	CB1961RNRP	5x5	10B	887838086730
711950132	IHTCB1961R	4.5x4.5	32D	887838086747
711950133	IHTCB1961R	5x4.5	32D	887838086754
711950134	CB1967R LH	5x4.5	26D	887838094889
711950135	CB1967R RH	5x4.5	26D	887838086761
711950136	CB1968R LH	5x4.5	26D	887838086778
711950137	CB1968R LH	5x4.5	10B	887838094896
711950138	CB1968R LH	5x4.5	32D	887838086785
711950139	CB1968R RH	5x4.5	26D	887838086792
711950140	CB1968R RH	5x4.5	10B	887838086808
711950141	CB1968R RH	5x4.5	32D	887838086815
711950142	CB1969R LH	5x4.5	26D	887838086822
711950143	CB1969R LH	5x4.5	10B	887838086839
711950144	CB1969R LH	5x4.5	32D	887838086846
711950145	CB1969R RH	5x4.5	26D	887838086853
711950146	CB1969R RH	5x4.5	10B	887838086860
711950147	CB1969R RH	5x4.5	32D	887838086877
711950148	CB1971R	4.5	26D	887838094902
711950149	CB1971R	4.5	10B	887838094919
711950150	CB1971R	4.5	32D	887838086884
711950151	CB1971R	5	26D	887838086891
711950152	CB1971R	5	32D	887838094926
711950153	CB1971R	5	10B	887838094933
711950154	CB1981R	4.5	10	887838094940
711950155	CB1981R	4.5	10B	887838094957
711950156	CB1981R	4.5	32D	887838094964
711950157	CB1981R	5	32D	887838094971
711950158	CB1981R	5	10B	887838094988
711950159	CB1981R	6	26D	887838094995
711950160	CB1991R	4.5	10	887838086907
711950161	CB1991R	4.5	10B	887838095008

## EDP Number to Class Number Cross Reference (cont.)

## Hinges & Door Accessories

EDP Number	Class Number	Size	Finish	UPC#
711950162	CB1991R	4.5	32D	887838086914
711950163	CB1991R	5	32D	887838086921
711950164	CB1991R	6	10B	887838095015
711950165	CB1991R	6	26D	887838095022
711950166	CECB1901R-54-LH	4.5x4	26D	887838086938
711950167	CECB1901R-54-LH	4.5x4	P	887838095039
711950168	CECB1901R-54-LH	4.5x4	10	887838095046
711950169	CECB1901R-54-LH	4.5x4	10A	887838095053
711950170	CECB1901R-54-LH	4.5x4	3	887838095060
711950171	CECB1901R-54-LH	4.5x4	10B	887838095077
711950172	CECB1901R-54-LH	4.5x4	26	887838095084
711950173	CECB1901R-54-LH	4.5x4.5	26D	887838086945
711950174	CECB1901R-54-LH	4.5x4.5	P	887838086952
711950175	CECB1901R-54-LH	4.5x4.5	10	887838095091
711950176	CECB1901R-54-LH	4.5x4.5	10A	887838095107
711950177	CECB1901R-54-LH	4.5x4.5	3	887838095114
711950178	CECB1901R-54-LH	4.5x4.5	10B	887838095121
711950179	CECB1901R-54-LH	4.5x4.5	26	887838086969
711950180	CECB1901R-56-LH	4.5x4	26D	887838086976
711950181	CECB1901R-56-LH	4.5x4	P	887838095138
711950182	CECB1901R-56-LH	4.5x4	10	887838095145
711950183	CECB1901R-56-LH	4.5x4	10A	887838095152
711950184	CECB1901R-56-LH	4.5x4	3	887838095169
711950185	CECB1901R-56-LH	4.5x4	10B	887838095176
711950186	CECB1901R-56-LH	4.5x4	26	887838095183
711950187	CECB1901R-56-LH	4.5x4.5	26D	887838086983
711950188	CECB1901R-56-LH	4.5x4.5	P	887838095190
711950189	CECB1901R-56-LH	4.5x4.5	10	887838095206
711950190	CECB1901R-56-LH	4.5x4.5	10A	887838086990
711950191	CECB1901R-56-LH	4.5x4.5	3	887838095213
711950192	CECB1901R-56-LH	4.5x4.5	10B	887838095220
711950193	CECB1901R-56-LH	4.5x4.5	26	887838095237
711950194	CECB1901R-58-LH	4.5x4	26D	887838087003
711950195	CECB1901R-58-LH	4.5x4	P	887838095244
711950196	CECB1901R-58-LH	4.5x4	10	887838095251
711950197	CECB1901R-58-LH	4.5x4	10A	887838095268
711950198	CECB1901R-58-LH	4.5x4	3	887838095275
711950199	CECB1901R-58-LH	4.5x4	10B	887838095282
711950200	CECB1901R-58-LH	4.5x4	26	887838095299
711950201	CECB1901R-58-LH	4.5x4.5	26D	887838087010
711950202	CECB1901R-58-LH	4.5x4.5	P	887838095305
711950203	CECB1901R-58-LH	4.5x4.5	10	887838095312
711950204	CECB1901R-58-LH	4.5x4.5	10A	887838087027
711950205	CECB1901R-58-LH	4.5x4.5	3	887838095329
711950206	CECB1901R-58-LH	4.5x4.5	10B	887838087034
711950207	CECB1901R-58-LH	4.5x4.5	26	887838095336
711950208	CECB1901R-66-LH	4.5x4	26D	887838087041
711950209	CECB1901R-66-LH	4.5x4	P	887838095343
711950210	CECB1901R-66-LH	4.5x4	10	887838095350
711950211	CECB1901R-66-LH	4.5x4	10A	887838095367

EDP Number	Class Number	Size	Finish	UPC#
711950212	CECB1901R-66-LH	4.5x4	3	887838095374
711950213	CECB1901R-66-LH	4.5x4	10B	887838095381
711950214	CECB1901R-66-LH	4.5x4	26	887838095398
711950215	CECB1901R-66-LH	4.5x4.5	26D	887838087058
711950216	CECB1901R-66-LH	4.5x4.5	P	887838095404
711950217	CECB1901R-66-LH	4.5x4.5	10	887838095411
711950218	CECB1901R-66-LH	4.5x4.5	10A	887838095428
711950219	CECB1901R-66-LH	4.5x4.5	3	887838095435
711950220	CECB1901R-66-LH	4.5x4.5	10B	887838095442
711950221	CECB1901R-66-LH	4.5x4.5	26	887838095459
711950222	CECB1901R-54-RH	4.5x4	26D	887838087065
711950223	CECB1901R-54-RH	4.5x4	P	887838095466
711950224	CECB1901R-54-RH	4.5x4	10	887838095473
711950225	CECB1901R-54-RH	4.5x4	10A	887838095480
711950226	CECB1901R-54-RH	4.5x4	3	887838095497
711950227	CECB1901R-54-RH	4.5x4	10B	887838095503
711950228	CECB1901R-54-RH	4.5x4	26	887838095510
711950229	CECB1901R-54-RH	4.5x4.5	26D	887838087072
711950230	CECB1901R-54-RH	4.5x4.5	P	887838095527
711950231	CECB1901R-54-RH	4.5x4.5	10	887838095534
711950232	CECB1901R-54-RH	4.5x4.5	10A	887838087089
711950233	CECB1901R-54-RH	4.5x4.5	3	887838095541
711950234	CECB1901R-54-RH	4.5x4.5	10B	887838095558
711950235	CECB1901R-54-RH	4.5x4.5	26	887838095565
711950236	CECB1901R-56-RH	4.5x4	26D	887838087096
711950237	CECB1901R-56-RH	4.5x4	P	887838095572
711950238	CECB1901R-56-RH	4.5x4	10	887838095589
700450082	CECB191-12C	4.5" X 4.5"	3	
700450089	CECB179-12C	5" X 4.5"	10B	



## Quoting & Ordering

Price quotations are based on one (1) shipment to one (1) location, and are valid as identified in the quote but in no case longer than one year from the date of the quote. All exceptions will be evaluated on an individual basis.

All quotation requests will be provided by the dormakaba Canada Inc. ("dormakaba Canada") Representative where the project is located.

**QUOTING PROCESS AND PROCEDURES:** The following information is necessary to secure a price quotation from dormakaba Canada.

- Distributor Name
- Distributor Location
- Distributor Contact Name and Phone Number
- Distributor e-mail contact
- Project Name
- Project Location
- Bid Date
- Architects Name, Phone Number and Architects Location
- Specification Writer Name, Phone Number and Location
- Competitive Influence / Specification

List of materials to be quoted Every attempt will be made by dormakaba Canada to provide the price quotation in a timely manner. Upon completion, you will receive a copy of the quotation which will also include a valid quotation number. Once the project is secured, a copy of the quotation must accompany your purchase order and be forwarded to dormakaba Canada Customer Service Department in Indianapolis for processing.

**NON-STANDARD PRODUCT REQUEST:** Please contact your dormakaba Canada Representative to complete a Non-Standard Product Request Form.

All New Orders/changes: [canadaorders.ca@dormakaba.com](mailto:canadaorders.ca@dormakaba.com) or call **1 888 539-7226**

Status, expedite and general inquiries: [canadaCSHelp.ca@dormakaba.com](mailto:canadaCSHelp.ca@dormakaba.com)

Returns and credit requests: [canadaRGACreditGrp.ca@dormakaba.com](mailto:canadaRGACreditGrp.ca@dormakaba.com)

Upon receipt of a special order request, dormakaba Canada will review the configuration and determine if dormakaba Canada is capable of making the special order product and will provide a response to the customer. If dormakaba Canada is able to make the special order product, dormakaba Canada will provide a specific sku/configuration to the customer for the special order product. This sku/configuration must be identified on all Purchase Orders. In addition, the Purchase Order must be marked as a "Special Order".

**ORDERING:** The following information is required for dormakaba Canada to successfully process any order:

- Itemized Purchase Order (PO)
- dormakaba Canada Approved Quote

**NOTE:** For detailed information on how to place an order for dormakaba Canada products as well as BEST masterkey services please see the detailed section regarding "Best Ordering".

**ADD ON ORDERS FOR QUOTED PROJECTS:** To place an add-on order from a quoted project the Distributor must include the original quote, PO number and/or dormakaba Canada's original order number. Add-On orders will be accepted for a period one (1) year from the original order date. Add-On orders received that are outside of the aforementioned period will be forwarded to the dormakaba Canada Representative for re-quote.

**STOCKING ORDERS:** All orders for stock replenishment should be

marked as "Stock" and indicate a "Ship To" address that coincides with the stocking Distributor warehouse location.

**INCOMPLETE ORDER PROCESS:** All orders are screened upon receipt for complete information. If an order is received incomplete, dormakaba Canada Customer Service will make one (1) attempt to contact a Distributor directly for the missing requirements. If the information is not made available to dormakaba Canada at that time the order will be referred to the local dormakaba Canada Representative for resolution. All incomplete orders will be cancelled if not resolved after fourteen (14) calendar days.

**PRICE DISCREPANCY PROCESS:** All entered orders are reviewed by dormakaba Canada Customer Service for accuracy and pricing consistency between the Distributor and dormakaba Canada. Any order determined by dormakaba Canada, in its sole and absolute discretion, to have a value greater than the Total Price shown on the Distributor purchase order will be held by dormakaba Canada for a Price Discrepancy. dormakaba Canada quotes are also reviewed to ensure that they are complete, approved, and match the PO. Due to pricing sensitivity, all price discrepancies must be resolved exclusively by your dormakaba Canada Representative.

**ORDER CANCELLATION/CHANGES:** All requests for Order Cancellations and Changes (Quantity, Shipping, Finish, Function, etc) should be sent directly to dormakaba Canada Customer Service. Requests via phone will be accepted, but must be accompanied by a written request. Factory Order Number, PO Number, Account Info, and Detailed Changes must be clearly indicated. Change requests can be submitted via the following methods:

**Email:** [canadaorders.ca@dormakaba.com](mailto:canadaorders.ca@dormakaba.com)  
**Phone 888-539-7226**

All order cancellations or changes will be subject to a cancellation fee as defined in dormakaba Canada's Terms and Conditions of Sale.

**PRODUCTION SCHEDULING AND "DO NOT SHIP BEFORE" REQUESTS:** All orders are scheduled for production and shipping based on current production lead times and availability. Scheduling is completed only when an order is released from both credit and pricing review.

Exceptions to this policy are made only when the PO is clearly marked: "Do Not Ship Before" followed by the date. (Required Date, Expected Date, etc. do not apply) These orders will be scheduled to ship on or after the date listed.

Changes to "Do Not Ship Before" dates are required in writing and should be sent to: [CanadaCSHelp.ca@dormakaba.com](mailto:CanadaCSHelp.ca@dormakaba.com).

Be advised, orders not clearly marked with a "Do Not Ship Before" designation will be payable within normal terms from the actual shipment date.

**EXPEDITE REQUESTS:**

- Expedite requests will be reviewed and accommodated by dormakaba Canada based on production lead times and availability.

**Email:** [canadaCSHelp.ca@dormakaba.com](mailto:canadaCSHelp.ca@dormakaba.com)

**WHOLESALE PURCHASE:** Distributors are also free to utilize dormakaba Canada's Authorized Wholesalers to purchase product. dormakaba Canada does not make any guarantee of availability or pricing for purchases from an Authorized Wholesaler and the discounts afforded to Distributor by dormakaba Canada shall not apply to purchases from an Authorized Wholesaler. The terms and conditions and price of product shall be as mutually agreed between Distributor and Wholesaler.



## Returned Authorization (RA)

**RA REQUESTS:** A Return Authorization Form ("RA") must be utilized to return defective products still under warranty or products deemed repairable by dormakaba Canada Inc. ("dormakaba Canada"). All products returned to dormakaba Canada must have a correct Return Authorization (RA) number applied to the outside of the shipping carton. All products must be returned within sixty (60) calendar days of RA issue date. This process can take up to seven (7) days after product is received at dormakaba Canada's factory. If a defective product presents a security risk, an advance replacement may be requested.

**RA PROCESS:** Requests for warranty related returns can be initiated by submitting an e-mail to [canadaRGACreditGrp.ca@dormakaba.com](mailto:canadaRGACreditGrp.ca@dormakaba.com).

The RA Request Form must be completed entirely to process an RA. The following information will be needed:

- End User Name
  - Account Number
  - Contact Name
  - Phone Number
  - Purchaser Order Number
  - Sales Order Number
  - Item Number
  - Item Quantity
  - Description of the Problem
1. Upon review and approval of the submitted RA request, a claim number is logged and provided back to the requestor by a dormakaba Canada Team member.
  2. Once a claim number is issued, this number should be noted on all references and communications regarding the applicable situation to ensure a claim is easily identified.
  3. Defective product should be returned to the address below. The shipment must be marked with the approved RA claim number to ensure prompt processing and attention. All shipping charges prepaid by customer.

dormakaba Canada  
7301 Decarie Blvd  
Montreal, QC Canada H4P 2G7  
Phone 888-539-7226
  4. When material is received at dormakaba Canada's factory, dormakaba Canada will assess and determine the nature of the defect.
  6. Defective goods are replaced upon dormakaba Canada's determination.
  6. Credit for material and freight is issued only if deemed appropriate by dormakaba Canada. If approved, credit is initiated and a credit memo is mailed to the Distributor within fifteen (15) business days.

### **PURCHASE ORDERS:**

A Purchase Order (PO) will be required if the Product is:

1. Defective and not under warranty, or
2. An advance replacement is required without verification of whether the product is defective and under warranty.

Please send Purchase Orders to the following:

- Preferred Method e-mail:  
[canadaRGACreditGrp.ca@dormakaba.com](mailto:canadaRGACreditGrp.ca@dormakaba.com)

## Returned Authorization (RA) Non-Warranty

**RA POLICY:** A Return Authorization Form ("RA") must be utilized to return products that are not defective and otherwise in a resalable condition. Only goods with an invoice date of less than one (1) year will be considered for a non-warranty related return. All materials returned to dormakaba Canada Inc. ("dormakaba Canada") for any reason (other than warranty), must have a correct RA number applied to the outside of the shipping carton. A standard re-stocking charge (of the purchase price) will be applied to the Distributor's account for orders returned, including orders that were placed by customer in error. Transportation charges of returned goods must be prepaid by the Distributor. All goods must be returned within sixty (60) calendar days of RA issue date. All goods must be returned in original packaging and be in resalable condition. Product not returned in saleable condition is subject to disposal by dormakaba Canada with no credit issued. Commercial Hardware items that are special made to order items will not be returned under any circumstances.

**RA PROCESS:** Requests for non-warranty related returns can be initiated by submitting an e-mail to [canadaRGACreditGrp.ca@dormakaba.com](mailto:canadaRGACreditGrp.ca@dormakaba.com).

The RA Request Form must be completed entirely to process an RA. The following information will be needed:

- Company Name
  - Account Number
  - Contact Name
  - Purchaser Order Number
  - Sales Order Number
  - Item Number
  - Item Quantity
  - Phone Number
  - Description of the Problem
1. Upon review and approval of the submitted RA request, a claim number is logged and provided back to the requestor by a dormakaba Canada Team member:
  2. Once a claim number is issued, this number should be noted on all references and communications concerning said RA.
  3. Product should be returned to the address below. The shipment must be marked with the approved RA claim number to ensure prompt processing and attention. All shipping charges prepaid by customer.  
dormakaba Canada  
7301 Decarie Blvd  
Montreal, QC Canada H4P 2G7  
Phone 888-539-7226
  4. The RA will be processed once material is received at dormakaba Canada's factory provided it is received in its original packaging and is in saleable condition.
  5. Credit is issued to the Distributor account and a credit memo is mailed to the Distributor.

## Fulfillment Issues

Any quality issues (missing parts, wrong parts, handling, finish, etc) should be submitted electronically to: [canadaRGACreditGrp.ca@dormakaba.com](mailto:canadaRGACreditGrp.ca@dormakaba.com) or your Local dormakaba Canada Representative.

Please reference your original Purchase Order (PO) Number, Factory Order Number, Distributor Account, Contact Information (E-mail/Fax), and include a detailed description of the issue.

**1) ITEMS MISSING FROM A SHIPMENT:** If you have signed your shipment short, dormakaba Canada Customer Service will promptly issue a No Charge replacement order for the missing products.

If the shipment was not signed short but after review, dormakaba Canada Customer Service determines (based on shipping weights, packing lists, etc) that the order was indeed shipped short, a No Charge replacement will be issued.

If dormakaba Canada Customer Service cannot verify a shipping error, an advance replacement order will be entered, charged, and expedited to the Distributor. The quality issue will be forwarded to the Return Authorization Credit Group for resolution.

If it is determined that the item was omitted from the order due to a dormakaba Canada order entry error, a change order will be entered and expedited for the missing products.

Please see price book for further detail.

**2) WRONG ITEMS RECEIVED** (parts, handling, function, finish, etc):

Advanced replacements will be issued for any wrong items received. **Such orders will be charged based on pricing/ discounts from the original order.** The issue will be forwarded to dormakaba Canada's Return Authorization Credit Group for resolution.

Any quality issue that is determined to be either a dormakaba Canada order entry and/or manufacturing error will have an advanced replacement order entered and will be expedited. An RA will be issued to return the incorrect products. No re-stock fee will apply for dormakaba Canada order entry and/or manufacturing errors.





**dormakaba Canada**  
501 Marcel-Laurin Blvd.  
Montreal, QC Canada  
H4N 2M3

Phone 888-539-7226

**bestaccess.com**

For questions about ordering and to be sure you get the right configuration for your needs, [contact your BEST dormakaba sales representative.](#)  
7301 Decarie Blvd Montreal, QC Canada H4P 2G7 | **888 539 7226** | [bestaccess.com](#)

BEST is a trademark of dormakaba Holding® 2023 All rights reserved. BEST is a member of the dormakaba Group, one of the top three providers for access and security solutions, globally.

CANADA PL76HI 01-24 RI

